



HAL
open science

Towards model-based control of a steam Rankine process for engine waste heat recovery

Johan Peralez, Paolino Tona, Antonio Sciarretta, Pascal Dufour, Madiha Nadri

► **To cite this version:**

Johan Peralez, Paolino Tona, Antonio Sciarretta, Pascal Dufour, Madiha Nadri. Towards model-based control of a steam Rankine process for engine waste heat recovery. 2012 IEEE Vehicle Power and Propulsion Conference (VPPC), Oct 2012, South Korea. pp.289 - 294, 10.1109/VPPC.2012.6422718 . hal-00875423

HAL Id: hal-00875423

<https://ifp.hal.science/hal-00875423>

Submitted on 22 Oct 2013

HAL is a multi-disciplinary open access archive for the deposit and dissemination of scientific research documents, whether they are published or not. The documents may come from teaching and research institutions in France or abroad, or from public or private research centers.

L'archive ouverte pluridisciplinaire **HAL**, est destinée au dépôt et à la diffusion de documents scientifiques de niveau recherche, publiés ou non, émanant des établissements d'enseignement et de recherche français ou étrangers, des laboratoires publics ou privés.

Towards model-based control of a steam Rankine process for engine waste heat recovery

Johan Peralez
Paolino Tona
and Antonio Sciarretta
IFP Energies Nouvelles
Control, Signal and System Department
Lyon site
Rond-point de l'échangeur de Solaize, BP 3
69360 Solaize, France

Pascal Dufour
and Madiha Nadri
Université de Lyon, F-69003, France
Université Lyon 1
CNRS UMR 5007
Laboratory of Process Control
and Chemical Engineering (LAGEP)
43 bd du 11 novembre, 69100 Villeurbanne, France

Abstract—Control plays a critical role in enabling good performance of Rankine processes for waste heat recovery from prime movers. Despite that, literature on control design for those systems is scarce, and there is a real need for investigating approaches that can be effective in an industrial context, where rapid control prototyping must be followed by a viable calibration procedure.

The paper describes modeling and control of a pilot Rankine steam process for exhaust gas heat recovery from a spark-ignition engine, focusing in particular on the use of a reduced-order dynamic model of the system to compute a nonlinear feedforward action to better control the system during nominal operation. Model reduction is obtained at the heat-exchanger level. First, via the moving-boundary approach, which avoids the need for complex, finite-volume, models. Then, via a further reduction of the resulting evaporator model which captures its dominant dynamics.

The proposed control system is validated on a detailed reference simulator using a demanding driving cycle.

I. INTRODUCTION

In the last few years, engine waste heat recovery (WHR) systems based on the Rankine thermodynamic cycle have been the focus of intensive research for road transportation applications. To mention a few examples, BMW and Ford have recently worked on this topic for cars, Cummins, Caterpillar, Daimler Trucks and Volvo for trucks [1]. The interest of manufacturers is justified by announced reductions in fuel consumption ranging from 5 to 10%, depending on the system and the driving cycle.

Rankine processes for automotive applications apply the same principle used worldwide in industry to generate power: converting heat into work via the Rankine thermodynamic cycle. An external heat source supplies heat to a working fluid which circulates in a closed loop, via a heat exchanger (or a series of heat exchangers). Expansion of vaporized fluid (generally via a turbine) produces mechanical power. Vapor is then converted into liquid in a condenser which transfers heat to an external cold sink. A pump circulates the fluid at the required pressure.

In mobile applications, for the sake of compactness and weight saving, vaporization and superheating of the fluid

usually take place in a single heat exchanger, the evaporator. The expansion machine, whether it is a turbine or a positive displacement expander, can deliver mechanical power directly to the transmission, even though most of the systems are designed to produce electricity via a generator connected to the auxiliary network and/or an energy storage system. But the main differences with stationary applications lie in the limited capacity of the cold sink and in the transient and uncontrollable behavior of the hot source, both depending on driving conditions. The latter two characteristics make the operation of those systems quite difficult. Eventually, fuel consumption gains may prove (much) lower than expected, if the heat recovery system has to be shut down too often and/or it takes too long to attain power production conditions. An effective control system is essential to attain satisfactory performance over a broad range of operating conditions.

Despite the importance of control in this context, few papers have been published on control design for Rankine-based WHR. Among them we can cite [2] (from Honda) which provides some experimental results on a steam process for SI engines, [3] on generic control issues and [4] which provides a complete startup and shut-down procedure for a Rankine cycle system with ethanol as working fluid, for heavy-duty applications. On the more general topic of Organic Rankine Cycles (ORC) for waste heat recovery operating with variable heat sources (not necessarily for transport applications), [5] covers dynamic modeling and control of an ORC system with R234fa as a working fluid. A somewhat richer literature is available on dynamic modelling and control of vapor compression cycles, the “reverse” of Rankine cycles ([6], [7]). In both contexts, there is considerable interest in the development of simplified (*moving-boundary*, (MB)) models to reproduce two-phase behavior of heat exchanger without the complexity of the finite-volume approach ([8], [9]).

A previous paper of ours [10], presents a practical supervision and control system for a pilot Rankine steam process for engine exhaust gas heat recovery. For nominal operation, when the system is in the power-production mode, an original control strategy is proposed, which focuses more on ensuring

continuity of operation than on the pursuit of optimality and is implemented as a decentralized PI-control structure with static feedforward. In this paper, we propose a different control strategy, based on nonlinear model inversion, to enhance tracking and regulation performance in the power-production mode. The inverted model used to compute the feedforward part of control inputs comes from the reduction of a *moving-boundary* model of the evaporator.

II. SYSTEM DESCRIPTION

The system under consideration is illustrated in Fig. 1.

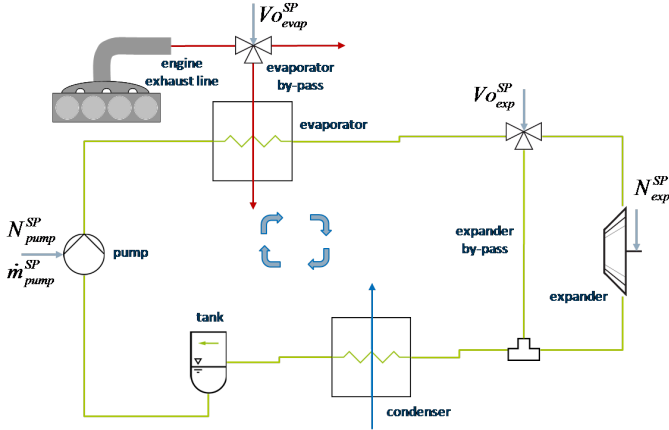

Fig. 1. Steam Rankine process under investigation

It is a pilot Rankine steam process for recovering waste heat from a SI engine on a test bench, designed to produce electric power via a positive-displacement expander connected to a generator (not shown). Expander speed can be adjusted by controlling generator load. The main manipulated variables (actuators) are shown in Fig. 2 (top left). Exhaust gas and condenser coolant conditions act as (measured) disturbances to the system. Main output variables are temperature – pressure pairs at each component inlet/outlet. The temperature – pressure pairs can be used to compute relevant thermodynamic variables, such as superheating or subcooling.

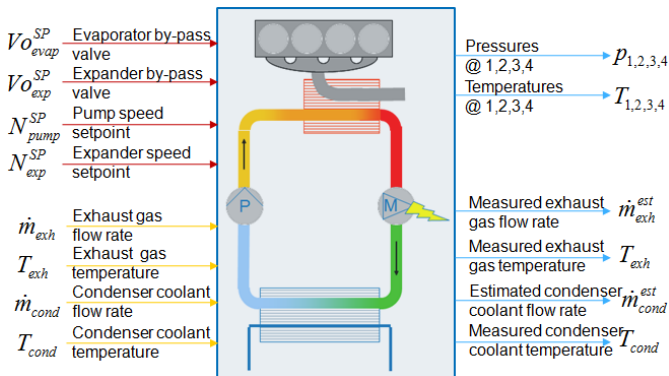

Fig. 2. Rankine steam process IO

III. SYSTEM MODELING

This section describes the modeling of the main components of the Rankine steam process. The models are written in the object-oriented, equation-based Modelica language, using Dymola.

The pump and the expander can be modeled via (standard) static equations, while the representation the complex two-phase behavior of heat exchangers requires non-straightforward dynamic modeling. MB models have experimentally proven their abilities to describe dynamics of heat exchangers [6]. For Rankine systems, 7th-order MB models usually yield sufficient accuracy, which can only be obtained with a very dense discretization, resulting in a high number of dynamics states, when standard Finite Volume (FV) models are used [11].

Nomenclature

Symbols

V	Volume (m^3)
S	Area (m^2)
ρ	Density (kg/m^3)
α	Heat transfer coefficient ($W/(m^2K)$)
c	Heat capacity ($J/(kg K)$)
h	Specific enthalpy (J/kg)
m	Mass (kg)
\dot{m}	Mass flow rate (kg/s)
p	Pressure (Pa)
T	Temperature (K)
L	Normalized zone length (–)
SH	Superheating (K)
N	Rotation speed (rpm)

Subscripts

<i>evap</i>	evaporator
<i>exp</i>	expander
<i>exh</i>	exhaust gas
<i>f</i>	working fluid
<i>w</i>	wall
<i>i</i>	zone i
<i>in</i>	inlet
<i>out</i>	outlet
<i>v</i>	saturated vapor
<i>l</i>	saturated liquid

A. Evaporator

The working fluid (water) enters the evaporator in the sub-cooled liquid phase and exits as superheated vapor. As shown by Fig. 3, MB models dynamically track the length of the fluid phases: normalized zone lengths L_1 , L_2 , L_3 respectively track liquid, two-phase and vapor zones (with $L_3 = 1 - L_1 - L_2$ due to normalization).

It is assumed in the following equations that pressure is homogeneous along the evaporator and conduction along the wall can be neglected. Then mass and energy balances can be applied to each of the 3 zones as follows:

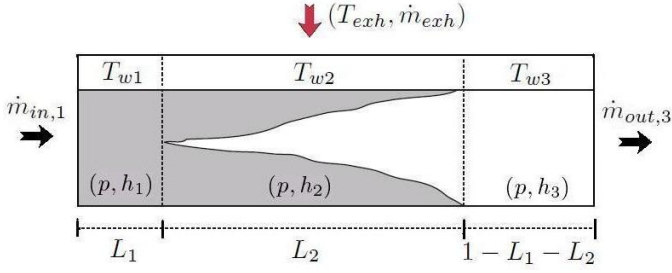

Fig. 3. Moving boundaries layout

1) *Working fluid mass balance*: For each zone i , water mass balance can be written $\frac{dm_i}{dt} = \dot{m}_{in,i} - \dot{m}_{out,i}$, where $m_i = \rho_i V_f L_i$ (ρ_i being the mean density of zone i). Considering L_i as time variant and density ρ_i as a function of pressure and enthalpy, yields:

$$\rho_i V_f \frac{dL_i}{dt} + \left(\frac{\partial \rho}{\partial p} \Big|_{h_i} \frac{dp}{dt} + \frac{\partial \rho}{\partial h} \Big|_p \frac{dh_i}{dt} \right) V_f L_i = \dot{m}_{in,i} - \dot{m}_{out,i} \quad (1)$$

where h_i is the mean enthalpy of zone i . For single phase zones (liquid or vapor), $h_i = \frac{h_{in,i} + h_{out,i}}{2}$ and for two-phase zone void fraction [12] can be introduced. Here, density ρ_i , and its partial derivatives $\frac{\partial \rho}{\partial p} \Big|_{h_i}$, $\frac{\partial \rho}{\partial h} \Big|_p$ are fluid properties, computed from the pair (p, h_i) .

2) *Working fluid energy balance*: Using the same approach, energy balance for water in each zone yields:

$$\rho_i V_f L_i \frac{dh_i}{dt} = \dot{m}_{in,i} (h_{in,i} - h_i) - \dot{m}_{out,i} (h_{out,i} - h_i) + \dot{Q}_{f,i} L_i + \frac{dp}{dt} V_f L_i \quad (2)$$

where $\dot{Q}_{f,i} = S_f \alpha_i (T_{w,i} - T_{f,i})$ represents heat transfer from wall.

3) *Wall energy balance*: For the wall, energy balance yields:

$$m_w c_w \frac{dT_{w,i}}{dt} = \dot{Q}_{exh,i} - \dot{Q}_{f,i} \quad (3)$$

where $\dot{Q}_{exh,i} = \dot{m}_{exh} c_{exh} \left(1 - \exp\left(-\frac{\alpha_{exh} S_{exh}}{\dot{m}_{exh} c_{exh}}\right) \right) (T_{exh} - T_{w,i})$ represents heat transfer from exhaust gas.

4) *Differential algebraic equations (DAE) system*: the equations introduced above are completed by interface equations. Fluid enthalpies and mass flows at zones 2-3 inlet correspond to zones 1-2 outlet; i.e $\dot{m}_{in,i+1} = \dot{m}_{in,i}$ and $h_{in,i+1} = h_{in,i}$ for $i = 1, 2$. For the two-phase zone, inlet and outlet enthalpies correspond to saturation values ($h_{in,2} = h_l$ and $h_{out,2} = h_v$). Finally the balance and interface equations constitute a DAE system with 7 dynamic states ($T_{w,1}, T_{w,2}, T_{w,3}, p, L_1, L_2, h_3$).

B. Condenser and tank

Condenser equations are based on the same principles used to obtain evaporator equations. Water enters the condenser

in vapor phase and is assumed exiting in liquid phase. Tank model captures the dynamics of fluid temperature and volume (due to changes in working fluid densities along the system).

C. Pump and expander

Because pump and expander dynamics are very fast compared to others components, a static model is used for them.

In the volumetric expander, volumetric flow rate can be assumed proportional to rotation speed N_{exp} [2]. Then mass flow rate is given by

$$\dot{m}_{exp} = N_{exp} \rho \eta_{exp} V_{exp} \quad (4)$$

where ρ is the fluid density at evaporator outlet, V_{exp} the expander displacement and η_{exp} the volumetric efficiency (assumed constant). The isentropic efficiency is also assumed to be constant.

The pump provides a mass-flow rate \dot{m}_{pump} at the evaporator inlet.

IV. MODEL REDUCTION FOR CONTROL

The MB modeling approach for heat exchangers of thermo-fluid systems, implementing vapor-compression or Rankine cycles, generally yields a 7th order model, when three zones are represented [12], [8]. Linearized MB models can be used for control: [13] shows that a state feedback is able to ensure stability around an operating point.

However, in Rankine systems for automotive applications, it is difficult to obtain good performance with a Linear Time Invariant (LTI) controller, for a realistic road cycle. Not only do these systems have to deal with strong disturbances from the hot source (exhaust gas), but the evaporator also presents strong non-linearities depending on the external conditions. Better performance can be expected using nonlinear control methods.

The full-order MB model of the evaporator introduced before, while simpler than FV models, is still too complex to be used for nonlinear control design in a straightforward way. This is why we have tried to capture its dominant dynamics in some reduced-order (non-linear) models.

A. Evaporator model reduction

Well-known reduction methods can be applied to a linearized MB model. In [14], the authors apply four reduction algorithms to the linearized model of an evaporator of an Organic Rankine Cycle for waste heat recovery.

A low-order non-linear model for the evaporator of a refrigeration system, based on a MB approach with two zones (vapor and two-phase), has been presented in [15]. However, in a Rankine cycle, the liquid zone always exists and has significant weight. [12] analyzes dominant time constants of evaporators and proposes a physical interpretation. Although the values of these time constants depend on operating points and system design (especially on volumes and working fluid type), fast and slow modes can be separated for typical evaporators. Slowest modes correspond to wall temperatures $T_{w,i}$ dynamics

and, because the liquid zone contains most of the fluid mass, dynamic of liquid zone length L_1 is also slow.

[16] proposes a discretization method for one-dimensional distributed parameters systems. This method consists in partitioning volumes into dynamic and static ones. It results in low-order models (though with a significant algebraic part) with the same steady states as the reference models. [16] applies it to a heat exchanger where fluid is assumed incompressible.

Adapting this concept to MB models, we propose hereafter two reduced models with three and four dynamic states, respectively with $[T_{w1} T_{w2} T_{w3}]'$ and $[T_{w1} T_{w2} T_{w3} L_1]'$ as state vector. The reference MB model considered is the 7th-order model described in Section III-A. Fastest modes are approximated by static variables (namely p , L_2 and h_3).

Under these assumptions, mass balance (1) can be rewritten as follows:

- for the liquid zone:

$$0.5 V_f L_1 \left. \frac{\partial \rho}{\partial h} \right|_p \dot{h}_{in} + \rho_1 V_f \frac{dL_1}{dt} = \dot{m}_{in,1} - \dot{m}_{out,1} \quad (5)$$

- for the two-phase zone:

$$0 = \dot{m}_{in,2} - \dot{m}_{out,3} \quad (6)$$

- for the vapor zone:

$$-\rho_3 V_f \frac{dL_1}{dt} = \dot{m}_{in,3} - \dot{m}_{out,3} \quad (7)$$

Energy balance is rewritten for water in the same way, while wall energy balance (3) is conserved. Finally, the 4th-order model is described by the following DAE system:

$$\begin{cases} m_w c_w \frac{dT_{w,i}}{dt} = \dot{Q}_{exh,i} - \dot{Q}_{f,i}, \quad i = 1, 2, 3 \\ 0 = 0.5 V_f L_1 \left. \frac{\partial \rho}{\partial h} \right|_p \dot{h}_{in,1} + \rho_1 V_f \frac{dL_1}{dt} - \dot{m}_{in,1} + \dot{m}_{out,1} \\ 0 = \dot{m}_{in,2} - \dot{m}_{out,3} \\ -\rho_3 V_f \frac{dL_1}{dt} = \dot{m}_{in,3} - \dot{m}_{out,3} \\ 0 = -0.5 V_f \rho_1 L_1 \dot{h}_{in,1} + 0.5 (\dot{m}_{in,1} + \dot{m}_{out,1})(h_{in,1} - h_l) \\ \quad + \dot{Q}_{f,1} L_1 \\ 0 = 0.5 (\dot{m}_{in,2} + \dot{m}_{out,2})(h_l - h_v) + \dot{Q}_{f,2} L_2 \\ 0 = 0.5 (\dot{m}_{in,3} + \dot{m}_{out,3})(h_v - h_{out}) + \dot{Q}_{f,3} (1 - L_1 - L_2) \end{cases} \quad (8)$$

where $\dot{Q}_{f,i}$, $\dot{Q}_{exh,i}$ and interface equations are unchanged with respect to the reference MB model (Section III-A).

With L_1 approximated as a static variable, mass balance can be written as $\dot{m}_{in,i} = \dot{m}_{out,i}$ for $i = 1, 2, 3$. Thus, the 3rd-order model is described by the following DAE system:

$$\begin{cases} m_w c_w \frac{dT_{w,i}}{dt} = \dot{Q}_{exh,i} - \dot{Q}_{f,i}, \quad i = 1, 2, 3 \\ 0 = -0.5 V_f \rho_1 L_1 \dot{h}_{in} + \dot{m}_{in,1}(h_{in,1} - h_l) + \dot{Q}_{f,1} L_1 \\ 0 = \dot{m}_{in,1}(h_l - h_v) + \dot{Q}_{f,2} L_2 \\ 0 = \dot{m}_{in,1}(h_v - h_{out,3}) + \dot{Q}_{f,3} (1 - L_1 - L_2) \end{cases} \quad (9)$$

B. Validation of reduced-order models

In order to compare the reduced models with the reference MB models, evaporator models are connected with pump and expander described in Section III-C. Their responses in terms of pressure and outlet superheating are compared in Fig. 4, for varying input conditions. The variations on control and disturbance inputs are as follows: at $t = 100s$, $600s$, $1100s$ steps are performed respectively on pump mass flow, exhaust mass flow and exhaust temperature. Plots confirm that steady-state behavior of reduced and reference models are similar. The 3rd-order model reproduce perfectly slower dynamics but not sufficiently fast. The 4th-order model dynamic behavior is very close to the reference MB. In particular, the inverse responses are well reproduced.

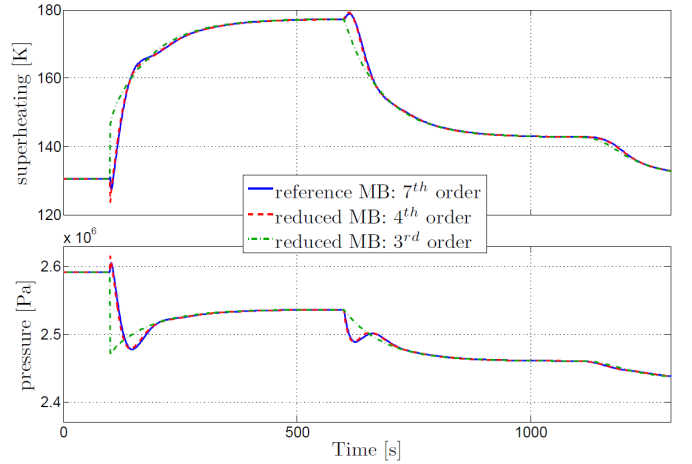

Fig. 4. Open loop response of full-order and reduced models to varying input conditions

V. CONTROL

The overall control structure for the Rankine pilot process is the same as in [10]. It is a hierarchical structure, coded in Simulink, with modules for sensors and actuators management, for system supervision and control. In nominal mode, when power is produced, evaporator and expander by-pass are closed, and two actuators are available to control the Rankine process: N_{pump} or (indirectly) \dot{m}_{pump} and N_{exp} . Pressure p and superheating SH at evaporator outlet are the controlled outputs. Those variables must track setpoints chosen so as to ensure safety and maximize produced power, despite varying external conditions.

A. Limits of decentralized PI control

The pragmatic control approach for the Rankine process in power-production mode followed in [10] consisted in the following steps:

- identifying the two-input two-output (TITO) transfer matrix of the system, with \dot{m}_{pump} and N_{exp} as inputs, and pressure p and superheating SH as outputs;
- finding the appropriate input-output pairing via (dynamic) relative gain analysis (RGA);

"Hot" operating point			"Cold" operating point		
y^0	SH	200 K	y^0	SH	200 K
	p	2.5 MPa		p	2.5 MPa
u_2^0	\dot{m}_{pump}	0.005855 kg/s	u_1^0	\dot{m}_{pump}	0.0010156 kg/s
	N_{exp}	712.5 rpm		N_{exp}	134.3 rpm
d_2^0	T_{exh}	600°C	d_1^0	T_{exh}	400°C
	\dot{m}_{exh}	0.05 kg/s		\dot{m}_{exh}	0.02 kg/s
	T_{in}	70°C		T_{in}	30°C

TABLE I
DEFINITION OF "HOT" AND "COLD" OPERATING POINTS

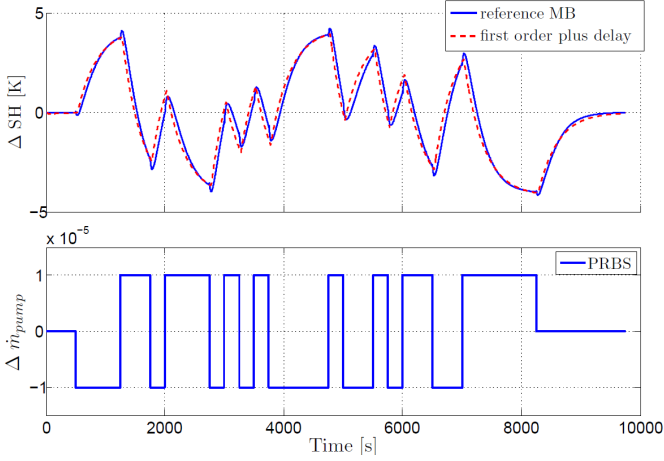

Fig. 5. Validation of FOPTD model for the $\{\dot{m}_{pump} - SH\}$ pair on the "cold" operating point

- designing a decentralized PI control system using the diagonal terms of the TITO transfer matrix.

The problem with this control structure, and similar ones encountered in literature [2], [5], is that identified linear models for thermo-fluid systems are very sensitive to external conditions. Let us consider the two operating points described in TABLE I, with the same system outputs y^0 , obtained for different ("hot" and "cold") exhaust gas conditions met during a typical driving cycle. The dynamic relation between \dot{m}_{pump} and SH can be fairly well described (around an operating point) by a first order plus time delay (FOPTD) model $\frac{Y(s)}{U(s)} = \frac{K_p}{1+\tau_p s} e^{-T_p s}$. This is confirmed by validation results of a FOPTD model identified on the reference MB model, shown in Fig. 5.

However, as the system has strongly non-linearities, the FOPTD parameters change a lot for the two operating points (TABLE II). A conservative (slow) PI feedback is thus required to preserve stability in the presence of model mismatch (long delays in superheating response to pump variations are particularly harmful). In this context, accurate tracking of arbitrary setpoints is impossible. In [10], in order to obtain acceptable results on a realistic driving cycle, we have to both detune the PI controllers and add a static feedforward action on the pump. This helps to improve superheat control performance and to generate sustainable setpoints, favoring the continuity of operation over the search for optimality.

	K_p	τ_p	T_p
"Hot" operating point	$-1.36e^5$ K/kg.s	60.1 s	8.4 s
"Cold" operating point	$-4.28e^5$ K/kg.s	345 s	30 s

TABLE II
IDENTIFIED MODEL PARAMETERS AROUND THE TWO OPERATING POINTS

B. Nonlinear inversion-based control

Fig. 6 shows the structure of the new controller we propose for the Rankine steam process. The inverse of a system model in the feedforward path computes the input trajectories u_d corresponding to the desired system outputs (setpoints y^{SP}), given the current disturbances d . A decentralized feedback controller applies a correction on u_d so as to y tracks y^{SP} in the presence of model uncertainty. Notice that, among the disturbances, T_{exh} and T_{in} are easily measurable, while an estimation of \dot{m}_{exh} can be provided by the engine control unit.

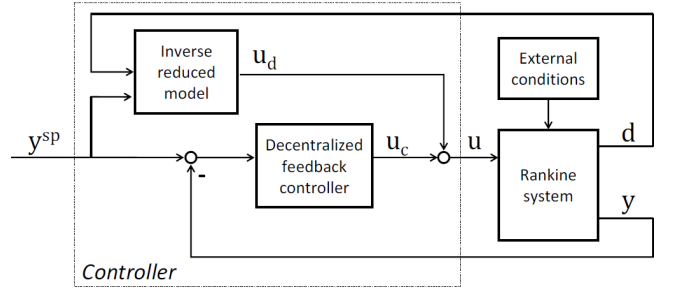

Fig. 6. Controller with inverse of reduced-model in the feedforward path.

The 4th-order reduced model is more accurate than the 3th-order one but cannot be inverted exactly because it is non-minimum phase. So the 3th-order reduced model will be used. Evaporator mass flow (considered as homogeneous in the 3rd-order model) can be explicitly computed from the DAE system (9). It constitutes the feedforward part $u_{1,d}$ of the first control input $u_1 = \dot{m}_{pump}$. Expander rotational speed can be explicitly computed from equation (4). It constitutes the feedforward part $u_{2,d}$ of the second control input $u_2 = N_{exp}$. This yields the following equation system for dynamic feedforward:

$$\begin{cases} \frac{dT_{w,i}}{dt} = \frac{\dot{Q}_{exh,i} - \dot{Q}_{f,i}}{m_w c_w}, \quad i = 1, 2, 3 \\ u_{1,d} = \frac{(T_3 - T_{w3}) S_R \alpha_3}{h_v - h_{out} + \frac{(T_3 - T_{w3})(h_1 - h_{in}) \alpha_3}{\alpha_1 (T_{w1} - T_1)} + \frac{(T_3 - T_{w3})(h_v - h_1) \alpha_3}{\alpha_2 (T_{w2} - T_2)}} \\ u_{2,d} = \frac{u_{1,d}}{\rho_{out,3} \eta_{exp} V_{exp}} \end{cases} \quad (10)$$

where fluid properties h_v , h_1 , T_i and $\rho_{out,3}$ are determined from desired outputs (p^{SP} and SH^{SP}).

VI. RESULTS

Since, at the time of writing, the test bench set-up has not been finalized yet, the proposed nonlinear inversion-based control strategy is validated using the reference Rankine steam

process simulator in Dymola using the real-time control software in Simulink, which will be eventually implemented on the test-bench. Exhaust gas conditions come from experimental data (Fig. 7), recorded from the 2.0-liter turbocharged SI engine of a Renault Megane SCENIC II on a highway driving cycle (the Artemis Motorway Cycle). This paper focusing on nominal conditions, simulation starts on hot conditions (water at evaporator outlet is assumed to be superheated steam).

In order to assess tracking performance, set points (p^{SP} and SH^{SP}) are increased during simulation (Fig. 8). The control system ensures tight tracking of steam pressure, regardless of highly-varying exhaust conditions. Steam superheat is also fairly well controlled, with maximum absolute error of 7K.

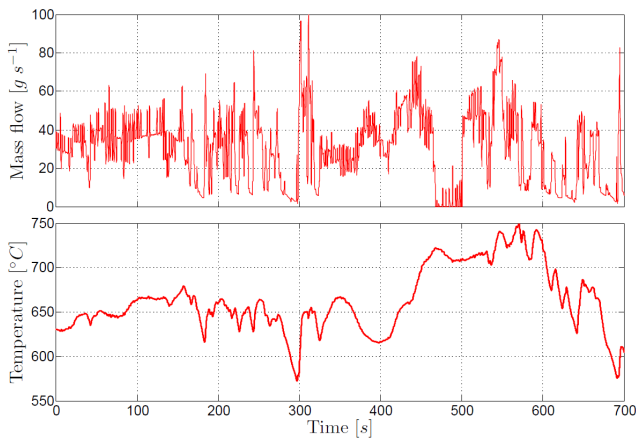

Fig. 7. Exhaust conditions (Artemis cycle)

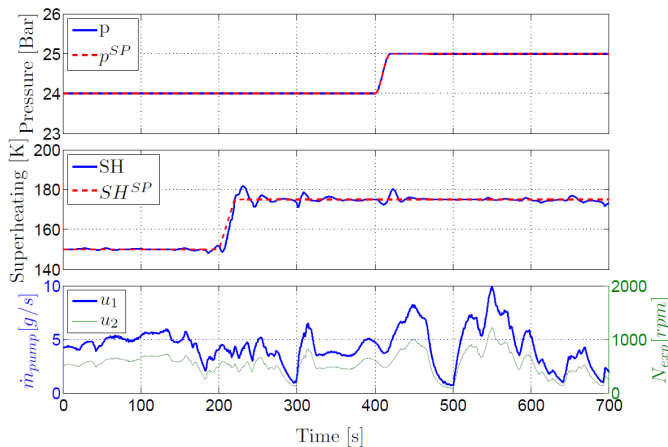

Fig. 8. Pressure and superheating regulation by nonlinear inversion-based control

VII. CONCLUSION

This paper reports two original reduced models of evaporator used in a Rankine steam process for waste heat recovery from a SI engine. The 3rd-order reduced model is subsequently used to design a nonlinear inversion-based controller. This

nonlinear model-based controller has the potential to overcome, on this kind of system, the shortcomings of LTI controllers and more particularly of the decentralized PI control strategies that are most often found in the literature.

Simulation on a demanding driving cycle confirms its ability to efficiently track pressure and superheating setpoints, allowing to pursue desired conditions at expander inlet in spite of disturbances (exhaust gas transients). Of course, an assessment on the experimental test bench will be necessary.

Further research will mostly focus on the expander: finding (dynamic) optimal conditions at expander inlet and considering possible saturations in its rotational speed.

REFERENCES

- [1] DEER, "Directions in Engine-Efficiency and Emissions Research Conference Proceedings," <http://www1.eere.energy.gov/vehiclesandfuels/resources/proceedings/index.html>.
- [2] T. Endo, S. Kawajiri, Y. Kojima, K. Takahashi, T. Baba, S. Ibaraki, T. Takahashi, and M. Shinohara, "Study on maximizing exergy in automotive engines," in *SAE 2007 World Congress*, no. 2007-01-0257, Detroit, MI, USA, Apr 2007.
- [3] R. Stobart, S. Hounsham, and R. Weerasinghe, "The controllability of vapour based thermal recovery systems in vehicles," in *SAE 2007 World Congress*, no. 2007-01-0270, Detroit, MI, USA, Apr 2007.
- [4] T. Park, H. Teng, G. Hunter, and B. e. a. van der Velde, "A rankine cycle system for recovering waste heat from HD diesel engines-experimental results," in *SAE 2011 World Congress*, no. 2011-01-1337, Detroit, MI, USA, Apr 2011.
- [5] S. Quoilin, R. Aumann, A. Grill, A. Schuster, V. Lemort, and H. Spliethoff, "Dynamic modeling and optimal control strategy of waste heat recovery organic rankine cycles," *Journal of Applied Energy*, 2011.
- [6] B. Rasmussen, "Dynamic modeling and advanced control of air conditioning and refrigeration systems," Ph.D. dissertation, University of Illinois at Urbana-Champaign, 2005.
- [7] A. Alleyne, B. Rasmussen, M. Keir, and B. Eldredge, "Advances in energy systems modeling and control," in *American Control Conference, 2007. ACC'07.* IEEE, 2007, pp. 4363–4373.
- [8] M. Gräber, N. Strupp, and W. Tegethoff, "Moving boundary heat exchanger model and validation procedure," in *EUROSIM Congress on Modelling and Simulation*, Prague, Czech Republic, 2010.
- [9] D. Wei, X. Lu, Z. Lu, and J. Gu, "Dynamic modeling and simulation of an organic rankine cycle (orc) system for waste heat recovery," *Journal of Applied thermal engineering*, vol. 28, no. 10, pp. 1216–1224, 2008.
- [10] P. Tona, J. Peralez, and A. Sciarretta, "Supervision and control prototyping for an engine exhaust gas heat recovery system based on a steam rankine cycle," in *2012 IEEE/ASME International Conference on Advanced Intelligent Mechatronics (AIM 2012)*, KaoHsiung, Taiwan, jul 2012.
- [11] D. Wei, X. Lu, Z. Lu, and J. Gu, "Performance analysis and optimization of organic rankine cycle (orc) for waste heat recovery," *Energy Conversion and Management*, vol. 48, no. 4, pp. 1113 – 1119, 2007.
- [12] J. Jensen, "Dynamic modeling of thermo-fluid systems with focus on evaporators for refrigeration," Ph.D. dissertation, Technical University of Denmark, 2003.
- [13] J. Zhang, W. Zhang, G. Hou, and F. Fang, "Dynamic modeling and multivariable control of organic rankine cycles in waste heat utilizing processes," *Computers & Mathematics with Applications*, no. 0, pp. –, 2012.
- [14] R. Wang, X. Zhao, C. Wang, and Y. Li, "Modeling and model order reduction of evaporator in organic rankine cycle for waste heat recovery," in *Advanced Mechatronic Systems (ICAMechS), 2011 International Conference on.* IEEE, 2011, pp. 291–296.
- [15] T. Cheng, X. He, and H. Asada, "Nonlinear observer design for two-phase flow heat exchangers of air conditioning systems," in *American Control Conference, 2004. Proceedings of the 2004*, vol. 2. IEEE, 2004, pp. 1534–1539.
- [16] A. Linhart and S. Skogestad, "An aggregation model reduction method for one-dimensional distributed systems," *AIChE Journal*, 2010.