



**HAL**  
open science

## Membrane fractionation of biomass fast pyrolysis oil and impact of its presence on a petroleum gas oil hydrotreatment.

Ana Pinheiro, Damien Hudebine, Nathalie Dupassieux, Nadège Charon, Christophe Geantet

### ► To cite this version:

Ana Pinheiro, Damien Hudebine, Nathalie Dupassieux, Nadège Charon, Christophe Geantet. Membrane fractionation of biomass fast pyrolysis oil and impact of its presence on a petroleum gas oil hydrotreatment.. Oil & Gas Science and Technology - Revue d'IFP Energies nouvelles, 2013, 68 (5), pp.815-828. hal-00909181

**HAL Id: hal-00909181**

**<https://ifp.hal.science/hal-00909181>**

Submitted on 23 Jan 2014

**HAL** is a multi-disciplinary open access archive for the deposit and dissemination of scientific research documents, whether they are published or not. The documents may come from teaching and research institutions in France or abroad, or from public or private research centers.

L'archive ouverte pluridisciplinaire **HAL**, est destinée au dépôt et à la diffusion de documents scientifiques de niveau recherche, publiés ou non, émanant des établissements d'enseignement et de recherche français ou étrangers, des laboratoires publics ou privés.

# Membrane Fractionation of Biomass Fast Pyrolysis Oil and Impact of its Presence on a Petroleum Gas Oil Hydrotreatment

A. Pinheiro<sup>1</sup>, D. Hudebine<sup>1\*</sup>, N. Dupassieux<sup>1</sup>, N. Charon<sup>1</sup> and C. Geantet<sup>2</sup>

<sup>1</sup> IFP Energies nouvelles, Rond-point de l'échangeur de Solaize, BP 3, 69360 Solaize - France

<sup>2</sup> IRCELYON, UMR 5256 CNRS, Université Lyon 1, 2 avenue A. Einstein, 69626 Villeurbanne Cedex - France  
e-mail: damien.hudebine@ifpen.fr

\* Corresponding author

**Résumé — Fractionnement membranaire d'une huile de pyrolyse flash et impact de sa présence sur l'hydrotraitement d'un gazole atmosphérique** — Les ressources limitées en pétrole brut et les limitations en termes de rejet de CO<sub>2</sub> suscitent un intérêt fort pour développer de nouvelles bases pour les carburants et la pétrochimie à partir de ressources lignocellulosiques. Deux voies principales sont actuellement étudiées pour transformer cette matière en carburants liquides : la gazéification et la liquéfaction. Dans ce dernier cas, un des traitements possibles serait d'hydrotraiter les huiles de pyrolyse flash en mélange avec des coupes pétrolières conventionnelles telles que les gazoles *Straight-Run* de manière à utiliser les unités d'hydrotraitement déjà existantes sur les sites de raffinerie.

Si des études antérieures mettant en jeu l'hydrotraitement d'un gazole *Straight Run* (SR), dans des conditions de désulfuration profonde, en présence de molécules oxygénées modèles et d'un catalyseur CoMo/Al<sub>2</sub>O<sub>3</sub> [Pinheiro *et al.* (2009) *Energy Fuels* **23**, 1007-1014; Pinheiro *et al.* (2011) *Energy Fuels* **25**, 804-812], ont montré que seul le monoxyde de carbone (CO) ou le dioxyde de carbone (CO<sub>2</sub>) issus de l'hydrodéoxygénation de certains composés (esters et acides carboxyliques) avaient un fort effet inhibiteur sur les autres réactions d'hydrotraitement et en particulier sur l'hydrodésulfuration des composés soufrés, l'impact du co-traitement du gazole SR et d'une base réelle issue de pyrolyse de lignocellulose n'avait pas encore été quantifié.

La présente étude fournit les résultats d'hydrotraitement de ce même gazole co-traité en présence d'une huile de pyrolyse flash ou d'une fraction de cette dernière. Par filtration membranaire, l'huile de pyrolyse a été séparée en quatre fractions en utilisant successivement deux membranes à 400 et 220 Da. La bio-huile ainsi que ses 4 fractions ont ensuite été caractérisées par différentes techniques spectroscopiques et chromatographiques. La fraction enrichie en composés de masse molaire comprise entre 220 et 400 Da a été hydrotraitée avec succès en mélange avec le gazole SR malgré quelques problèmes de stabilité de l'émulsion. L'effet inhibiteur observé sur les réactions d'hydrotraitement est en adéquation avec les quantités de CO/CO<sub>2</sub> formées par hydrodéoxygénation des acides carboxyliques quantifiés dans la fraction d'huile de pyrolyse et confirme les mécanismes inhibiteurs démontrés lors du co-traitement sur catalyseur CoMo/Al<sub>2</sub>O<sub>3</sub> d'une charge gazole SR et d'une source oxygénée issue de biomasse.

**Abstract — Membrane Fractionation of Biomass Fast Pyrolysis Oil and Impact of its Presence on a Petroleum Gas Oil Hydrotreatment** — In order to limit the greenhouse effect causing climate change and reduce the needs of the transport sector for petroleum oils, transformation of lignocellulosic biomass is a promising alternative route to produce automotive fuels, chemical intermediates and energy. Gasification and liquefaction of biomass resources are the two main routes that are under investigation to convert biomass into biofuels. In the case of the liquefaction, due to the instability of the liquefied products, one solution can be to perform a specific hydrotreatment of fast pyrolysis bio-oils with petroleum cuts in existing petroleum refinery system. With this objective, previous studies [Pinheiro et al. (2009) *Energy Fuels* **23**, 1007-1014; Pinheiro et al. (2011) *Energy Fuels* **25**, 804-812] have been carried out to investigate the impact of oxygenated model compounds on a Straight Run Gas Oil (SRGO) hydrotreatment using a CoMo catalyst. The authors have demonstrated that the main inhibiting effects are induced from CO and CO<sub>2</sub> produced during hydrodeoxygenation of esters and carboxylic acids.

To go further, cotreatment of a fast pyrolysis oil with the same SRGO as used in the previous studies was investigated in this present work. Firstly the bio-oil was separated into four fractions by membrane fractionation using 400 and 220 Da molecular weight cut-off membranes. The bio-oil and its fractions were analyzed by spectroscopic and chromatographic techniques. Then, one fraction (i.e. fraction enriched in compounds with molecular weight from 220 to 400 Da) was mixed with the SRGO and co-treated. Despite some experimental difficulties mainly due to the emulsion instability, the hydrotreatment was successful. An inhibition has been observed on the hydrotreating reactions of the SRGO in presence of the bio-oil fraction. The measurement of the CO/CO<sub>2</sub>/CH<sub>4</sub> molar flowrate at the reactor outlet showed that the inhibition was due to the presence of CO and CO<sub>2</sub> coming from HDO rather than to the oxygen compounds themselves.

## INTRODUCTION

Nowadays, the low-price crude oil resource limitations as well as the constraints for the greenhouse gases emission raise a strong interest for developing new bases for automotive fuels. In this context, renewable resources such as lignocellulosic biomass (forest or agricultural residues, herbaceous crops, etc.), fats or vegetable oils and carbohydrates would be good candidates for alternative fuels. One possible route consists in the direct liquefaction of lignocellulosic biomass by flash pyrolysis, hydrothermal conversion or hydroliquefaction (Bridgewater, 2007; Demirbas and Balat, 2007; Zhang *et al.*, 2007; Demirbas, 2007). In most cases, due to their high oxygen content, the quality of these liquefied products is poor, especially in terms of stability and heat capacity so post-treatments are required in order to eliminate oxygen. Different processes can be proposed in order to remove the oxygen from the bio-fuels but the best known of them is doubtless the hydrotreatment which allows to remove oxygen by HydroDeOxygenation (HDO). A solution is to perform a specific hydrotreatment of the bio-oils in an existing petroleum refinery for practical reasons such as hydrogen availability, protected area or technical support. Both coprocessing in FCC or HDT units have been investigated for bio-oils which have been previously stabilized and partially converted (de Miguel Mercader

*et al.*, 2011). However, the small quantity of bio-oils compared to the amount of the other petroleum products encountered in the refineries suggests another solution where bio-oils and petroleum cuts (for example Atmospheric Gas Oils, AGO) are hydrotreated together. In this last case, two questions have to be answered before investigating more deeply this process scheme: are oxygen compounds completely removed by HDO in the operating conditions of a conventional AGO hydrotreating unit? Is there an inhibiting effect of the oxygen compounds on the other hydrotreating reactions, especially the HydroDeSulfurization (HDS) of the AGO? Several studies have been performed in recent years in order to answer these questions (Furimsky, 2000; Kokayeff, 2005; Tailleux, 2006; Elliott, 2007; Huber and Corma, 2007; Philippe *et al.*, 2010). A previous study (Pinheiro *et al.*, 2009) enabled the authors to evaluate the impact of various oxygen model compounds (i.e. 2-propanol, cyclopentanone, anisole, guaiacol, propanoic acid and ethyldecanoate) on a Straight Run Gas Oil (SRGO) hydrotreatment using a sulfided CoMo/Al<sub>2</sub>O<sub>3</sub> catalyst. These compounds were selected as being representative of the chemical families present in biomass fast pyrolysis oils or partially hydrogenated bio-oils. The main conclusion of this work (Pinheiro *et al.*, 2009) was that oxygen model compounds which produce water by deoxygenation had no impact on the hydrotreatment of the SRGO under deep HDS

conditions whereas inhibition occurs at lower temperature (Bui *et al.*, 2009). On the contrary, propanoic acid and ethyldecanoate had a strong inhibiting effect, probably due to the formation of carbon monoxide and carbon dioxide. A second study (Pinheiro *et al.*, 2011) allowed the authors to confirm this hypothesis and to predict the impact of different quantities of CO/CO<sub>2</sub> on the hydrotreatment of the same SRGO in the same operating conditions as for the first study. The inhibiting effect of the carbon monoxide on the activity of CoMo catalysts has been also reported in other articles, even if the hydrotreatment was only performed on FCC gasolines (model compounds or real feeds) in these cases (Ghosh *et al.*, 2009; Pelardy *et al.*, 2010; Bouvier *et al.*, 2011).

The objective of the present work consists to investigate the cotreatment of a “real” bio-oil with a conventional SRGO. Firstly the bio-oil was separated into four fractions by membrane fractionation which were analyzed by complementary techniques such as, for example, size exclusion chromatography or mass spectrometry. Then one of the four fractions was mixed with the SRGO and co-treated in the following operating conditions: CoMo/Al<sub>2</sub>O<sub>3</sub> catalyst, reaction temperature: 330°C,  $P_{tot}$ : 5 MPa, LHSV (Liquid Hourly Space Velocity): 1.0 h<sup>-1</sup> and H<sub>2</sub>/HC<sub>outlet</sub>: 400 SL/L.

## 1 EXPERIMENTAL SECTION

### 1.1 Membrane Fractionation of a Fast Pyrolysis Oil

#### 1.1.1 Fast Pyrolysis Oil

The fast pyrolysis oil was produced from hardwoods and was provided by IFP Energies nouvelles. Based on wet basis, the bio-oil had a carbon content and an hydrogen content of 43.9 and 7.4%w/w respectively (according to modified ASTM D5291 method) and an oxygen content provided by coulometry of 47.2%w/w. The density of the sample was 1.2240 g/cm<sup>3</sup> at 15°C (NF EN ISO 12185 method) and its water content was equal to 22.8%w/w (ASTM E203 method).

#### 1.1.2 Membrane Nanofiltration System and Method

The fractionation procedure, described in Figure 1, has been performed in optimized experimental conditions (*i.e.* fractionation membranes, solvent, initial concentration of the bio-oil, pressure and temperature of nanofiltration system).

The fast pyrolysis oil was submitted to a preliminary filtration in order to remove the solids (defined as the ethanol insoluble materials) since they could interfere with the nanofiltration operation by causing membrane

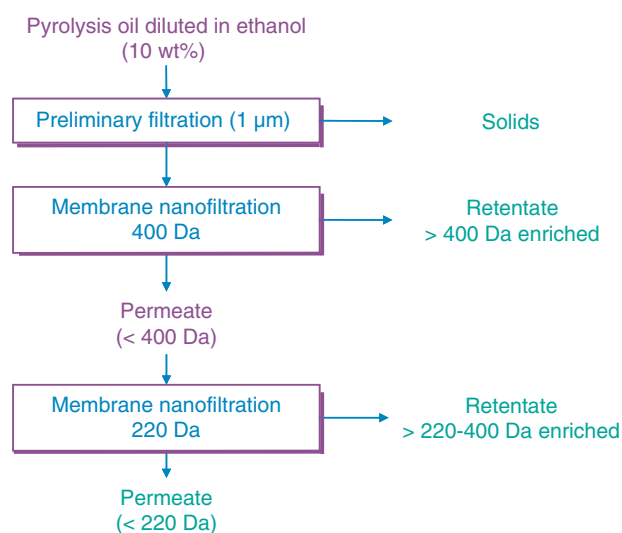

Figure 1

Bio-oil nanofiltration fractionation scheme.

fouling. So the sample was diluted in ethanol to obtain a mixture containing 10%w/w of bio-oil and solids were removed by vacuum filtration using a Büchner funnel equipped with a 10 μm porosity filter paper.

Once the solids were eliminated, the nanofiltration experiments were carried out using a membrane separation system METCell Crossflow provided by Membrane Extraction Technologies (Imperial College, London, UK). Dense polyimide nanofiltration flat membranes with 220 Da and 400 Da molecular weight cut-offs were used in this experiment (respectively Starmem 122 and Starmem 240 membranes, provided by MET, Imperial College, London UK). The Molecular Weight Cut-Off (MWCO) is defined as molecular weight for 90% rejection of normal alkanes dissolved in toluene, calibration being carried out by the supplier.

The METCell Crossflow system was loaded with the pyrolysis oil diluted in ethanol and pre-filtrated. The free-solids solution was then filtered by using a *Starmem* 240 membrane (MWCO 400 Da) at room temperature, under a constant total pressure of 2 MPa. The filtrate and the retentate fractions (*i.e.* fraction collected in the feed compartment at the end of the filtration test) were recovered. The filtration system was cleaned with ethanol and the *Starmem* 240 membranes were replaced by *Starmem* 122 membranes (MWCO 220 Da). The system was then loaded with the filtrate fraction, whose molecular weight distribution is theoretically lower than 400 Da, as represented in Figure 1. This fraction was also filtrated at room temperature and 2 MPa. So four fractions were finally obtained: a retentate > 400 Da

enriched, a retentate >220-400 Da enriched, a filtrate <400 Da and a filtrate <220 Da.

### 1.1.3 Analytical Methods

The fast pyrolysis oil and its four fractions were characterized using different complementary analytical techniques: elemental analyses for C, H, N and O contents determination, Size-Exclusion Chromatography (SEC) for molecular weight distributions, Fourier Transform-Ion Cyclotron Mass Spectrometry (FT-ICR/MS) for determination of chemical formulae by Kendrick diagrams as well as nuclear magnetic resonance ( $^{13}\text{C}$ -NMR) for structural characterization.

#### Elemental Analyses (C,H,N,O)

Carbon, hydrogen and nitrogen contents were analyzed according to ASTM D5291 method and oxygen content was determined by coulometry.

#### Size-Exclusion Chromatography (SEC)

SEC was performed on a Waters Alliance 2695 system, using a refractive index detector. The system was controlled using an Empower chromatography manager. Calibration was performed using 10 monodisperse polystyrene standards with masses in the range of 162-120 000 g/mol (*Polymer Laboratories*). Samples were injected at a concentration of 5 g/L in TetraHydroFuran (THF) with a volume of 50  $\mu\text{L}$ . The temperature was adjusted to 40°C and the flow rate was fixed at 0.7 mL/min. Three columns packed with PolyStyrene-DiVinylBenzene supports (PS-DVB, *Polymer Laboratories*) were chosen; the corresponding pore sizes were 10, 100 and 1 000 nanometers. The SEC data enable one to describe the weight distributions according to weight averages, calculated as follows:

$$M_n = \frac{\sum N_i M_i}{\sum N_i} \quad (1)$$

$$M_w = \frac{\sum N_i M_i^2}{\sum N_i M_i} \quad (2)$$

$$\text{PDI} = \frac{M_w}{M_n} \quad (3)$$

where  $N_i$  represents the number of molecules with a molecular weight of  $M_i$ .  $M_n$  is the number-average molecular weight,  $M_w$  is the weight-average molecular weight and PDI is the PolyDispersity Index.

#### Mass Spectrometry (FT-ICR/MS)

FT-ICR (Fourier Transform-Ion Cyclotron Resonance) mass spectrometry analyses were performed using a

*Thermo Scientific* LTQ FT Ultra (Bremen, Germany) composed of a linear ion trap and an ion cyclotron resonance cell in a 7 Tesla supraconducting magnet. Samples were diluted in ethanol at a concentration from 1 to 10%w/w and then diluted in methanol at 1%w/w prior to the injection by infusion mode at a flow rate of 3  $\mu\text{L}/\text{min}$ . Samples were ionized by a positive electrospray mode (ESI+). Mass spectra belonging to the [50-2 000 Da] mass range were acquired by ion trap mass spectrometry. A weight external calibration was carried out using a *CalMix+* mixture. Data treatment is achieved with a homemade software called Kendrick Inside (Omaïs *et al.*, 2012).

#### $^{13}\text{C}$ Nuclear Magnetic Resonance ( $^{13}\text{C}$ -NMR)

NMR experiments were performed using an Advanced 300 MHz *Bruker* spectrometer. The chemical shifts were referenced using Chloroform D as a solvent ( $\delta = 77.4$  ppm).

## 1.2 Co-Hydrotreatment of a Bio-Oil and a Petroleum Gas Oil

### 1.2.1 Pilot Unit Experiments

The hydrotreating experiments were carried out in a down-flow pilot-scale fixed-bed reactor system as shown in Figure 2. The reactor was loaded with a commercial CoMo/Al<sub>2</sub>O<sub>3</sub> hydrotreating catalyst (4 cm<sup>3</sup>). The catalyst was the same as for the previous studies carried out by Pinheiro *et al.* (2009, 2011). It was sulfided *in situ* at 350°C and 4 MPa during 12 hours by injecting

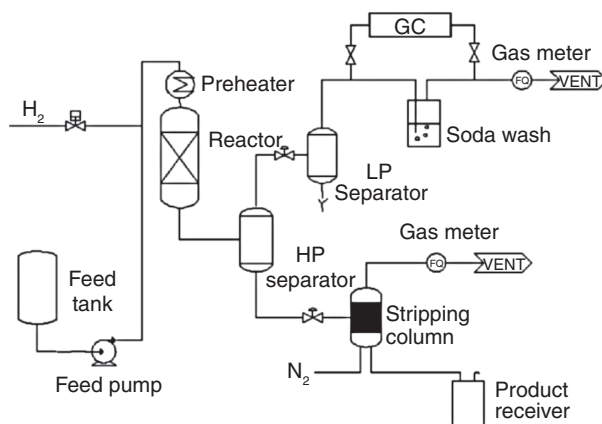

Figure 2  
Flow scheme of the pilot plant.

a Straight Run Gas Oil containing 2%w/w of DiMethylDiSulfure (DMDS). After sulfidation, the operating conditions were adjusted to the targeted values of temperature ( $T$ ), pressure ( $P_{tot}$ ), Liquid Hourly Space Velocity (LHSV) and hydrogen to hydrocarbon volumic ratio at the reactor outlet ( $H_2/HC_{outlet}$ ). LHSV (in  $h^{-1}$ ) and  $H_2/HC_{outlet}$  ratio (in SL/L) are defined as follows:

$$LHSV = \frac{Q_{feed}(15^\circ C)}{V_{cata}} \quad (4)$$

$$H_2/HC_{outlet} = \frac{Q_{H_2}(15^\circ C; 1 \text{ atm})}{Q_{feed}(15^\circ C)} \quad (5)$$

where  $Q_{feed}(15^\circ C)$  is the volumic flowrate of the feed at  $15^\circ C$  (L/h),  $V_{cata}$  is the volume of catalytic bed (L) and  $Q_{H_2}(15^\circ C; 1 \text{ atm})$  is the volumic flowrate of dihydrogen at  $15^\circ C$  and 1 atmosphere (SL/h) at the reactor outlet.

Experiments were carried out with the following operating conditions:  $T = 330^\circ C$  (isothermal profile along the reactor),  $P_{tot} = 5 \text{ MPa}$ ,  $LHSV = 1.0 \text{ h}^{-1}$  and  $H_2/HC_{outlet} = 400 \text{ SL/L}$ . Several feeds were tested:

- point 1: SRGO alone in order to determine the hydro-treating baseline in the absence of oxygen compounds;
- point 2: SRGO + 2.4%w/w ethanol for evaluating the potential effect of the presence of ethanol on the hydrotreating reactions;
- point 3: SRGO + 2.4%w/w ethanol + 2.4%w/w of retentate enriched in  $> 220\text{-}400 \text{ Da}$ . It is the point of interest of this study;
- point 4: SRGO alone in order to verify that the presence of oxygen compounds did not deactivated the catalyst.

After each modification of the operating conditions, the pilot unit required several days to reach its new steady-state conditions. For this reason, density at  $15^\circ C$  and sulfur content of the liquid effluent were analyzed twice per day until the stabilization. Once this objective reached, the effluent was recovered and analyzed by different techniques in order to determine its properties (density at  $15^\circ C$ , refractive index at  $20^\circ C$ , elemental analysis, etc.).

### 1.2.2 Analytical Methods

The density at  $15^\circ C$ , the refractive index at  $20^\circ C$ , the sulfur content and the nitrogen content were determined on the feed and on the hydrotreated effluents. Densities at  $15^\circ C$  were measured with an Anton Paar DMA 4500 densimeter according to the NF EN ISO 12185/96 norm. Refractive indices at  $20^\circ C$  were determined with an Anton Paar RXA 170 analyzer according to the ASTM D1218/D1747 standards. The total sulfur contents were measured by X-fluorescence on a Phillips PW 2400

spectrometer (ASTM D2622) and the total nitrogen contents were determined by chemiluminescence in an Antek 9000 series apparatus (ASTM D4629 if  $N < 100 \text{ mg/kg}$  or NF0758 if  $N > 100 \text{ mg/kg}$ ). The aromatic carbon content (Ca content) was determined by the n-d-M method from density, refractive index and molecular weight measurements (ASTM D3238).

### 1.2.3 Materials

The experiments were performed with the same SRGO as for the previous works (Pinheiro *et al.*, 2009, 2011). Table 1 summarizes its main characteristics. The used SRGO was a typical Middle-East straight-run gas oil with a nitrogen content of 127 wt ppm and a sulfur content equal to 1.35%w/w. The density at  $15^\circ C$  was  $0.8537 \text{ g/cm}^3$ . The SRGO contained 126 wt ppm of water.

TABLE 1  
Main characteristics of the Straight-Run Gas Oil used for the study

Analyses	Values
Density at $15^\circ C$	$0.8537 \text{ g/cm}^3$
Refractive index at $20^\circ C$	1.4758
Sulfur content	1.35%w/w
Nitrogen content	127 wt ppm
Aromatic carbon content	16.6%
Water content	126 wt ppm

The bio-oil co-treated with the SRGO was the retentate enriched in  $> 220\text{-}400 \text{ Da}$  coming from the nanofiltration of the bio-oil presented in this article. Its elemental composition is given in Table 2.

Mixing bio-oils with petroleum gas oils proved to be difficult because bio-oils which are mainly composed of polar compounds are insoluble in non-polar petroleum gas oils. In order to avoid this difficulty, the use of a co-solvent, ethanol, was required. After several tests with different proportions of SRGO/retentate/ethanol for maximizing the stability of the emulsion, it was observed that the most stabilized emulsions were obtained when the retentate was mixed with ethanol in same proportions. Consequently, it was decided to mix SRGO with 2.4%w/w of retentate enriched in  $> 220\text{-}400 \text{ Da}$  and 2.4%w/w of ethanol. The final mixture contains 1%w/w of oxygen coming from the retentate and 0.96%w/w of oxygen coming from ethanol.

TABLE 2  
Elemental analyses and H/C and O/C mol ratios of bio-oil and its nanofiltration fractions after removal of ethanol (on wet basis)

	Bio-oil	Retentate enriched in >400 Da	Permeate < 400 Da	Retentate enriched in >220-400 Da	Permeate < 220 Da
C (%w/w)	54.5	55.7	50.4	50.8	50.0
H (%w/w)	6.49	6.69	7.05	6.74	6.79
N (%w/w)	0.12	0.13	<0.05	<0.05	<0.05
O (%w/w)	38.3	37.2	41.6	41.9	42.2
H/C (mol/mol)	1.43	1.44	1.68	1.59	1.63
O/C (mol/mol)	0.53	0.50	0.62	0.62	0.63

## 2 MEMBRANE FRACTIONATION OF A FAST PYROLYSIS OIL

### 2.1 Mass Balances

Mass balance and material losses can be estimated for each step of the bio-oil membrane fractionation procedure since pyrolysis oil content of every fraction can be estimated after ethanol evaporation with a rotary vacuum system. Evaporation step and samples handling can cause some light compounds losses. Mass balance was standardized to 100 g of initial pyrolysis oil basis, *i.e.* 1 000 g of a bio-oil diluted in ethanol in proportion 10%w/w (*Tab. 3*).

The main material loss was observed during the first separation step (*i.e.* filtration with the MWCO 400 Da membrane) where 30 g from the 99 g of pyrolysis oil was not recovered. The second separation step (*i.e.* filtration with a MWCO 220 Da membrane) induced

a moderate loss (3 g of bio-oil were not recovered from the 20 g of the permeate < 400 Da).

The material losses were mainly due to the film deposit of the bio-oil molecules on the inox and glass surfaces of the nanofiltration apparatus in a significant way. However, despite this experimental bias, the four obtained fractions have been considered as characteristic and have been analyzed using different techniques.

### 2.2 Analytical Characterization of Bio-Oil Membrane Fractions

#### 2.2.1 Molecular Weight Distributions

Molecular weight distribution of the bio-oil (with no solids) as well as those of the four nanofiltration fractions have been investigated by Size-Exclusion Chromatography (SEC) combined with a Refractive Index (RI) detector

TABLE 3  
Nanofiltration mass balance results, in a 100 g of initial bio-oil basis after removal of ethanol

	Solution mass (g)	Bio-oil concentration (%w/w)	Bio-oil mass (g)
Bio-oil/ethanol solution before solid filtration	1 000	10.0	100
Filtered bio-oil at 1 $\mu$ m	980	10.1	99
<i>Losses after pre-filtration</i>	20		1
Retentate enriched in > 400 Da	263	18.8	49
Permeate < 400 Da	677	2.9	20
<i>Losses after 1st filtration (400 Da)</i>	40		30
Retentate enriched in > 220-400 Da	288	3.1	9
Permeate < 220 Da	384	2.0	8
<i>Losses after 2nd filtration (220 Da)</i>	5		3

TABLE 4  
Weight and number average molecular weight and PolyDispersity Index (PDI) obtained by SEC-RI analysis (results expressed in polystyrene equivalent)

	$M_w$ (g/mol)	$M_n$ (g/mol)	PDI
Pyrolysis oil before fractionation	580	360	1.64
Enriched > 400 Da fraction	610	400	1.55
< 400 Da fraction	230	210	1.10
Enriched > 220-400 Da fraction	250	220	1.13
< 220 Da fraction	210	200	1.07

(THF used as eluant). It should be mentioned that results obtained by using SEC technique were expressed in polystyrene standard equivalents since a mixture of Polystyrene compounds (PS) was used for the molecular weight calibration.

According to Table 4, SEC results evidence that the bio-oil and the > 400 Da retentate have close molecular weight properties in terms of  $M_w$ ,  $M_n$  and PDI values, whereas the < 400 Da permeate exhibit different properties (*i.e.* much lower  $M_w$ ,  $M_n$  and PDI values). Therefore, the first fractionation step using a MWCO 400 Da membrane enables an efficient separation of bio-oil into an enriched high molecular weight fraction (with a mean  $M_w$  of 610 g/mol PS equivalent) and a lower molecular weight fraction. Since the < 400 Da permeate has a molecular weight distribution centered around 230 g/mol PS eq., it clearly appears that a second fractionation step involving a MCO 220 Da is not required, that is confirmed by the SEC data (same average molecular weight values for the < 400 Da fraction, the enriched > 220-400 Da fraction and the < 220 Da fraction).

### 2.2.2 Information About Chemical Structures

#### Elemental Analyses

Elemental analyses of the initial sample and the four obtained fractions were measured after ethanol evaporation (Tab. 2). These results show that H/C and O/C mass ratios of the retentate enriched in > 400 Da are very similar to those obtained for the bio-oil whereas the permeate < 400 Da has much higher H/C and O/C mass ratios. This may be related to the fact that aromatic phenolic/pyrolytic lignin can be mainly concentrated into the retentate > 400 Da. It is interesting to notice that nitrogen is essentially present in the retentate > 400 Da. However, hypothetical chemical structures of pyrolytic lignin including nitrogen functions are usually not reported in literature despite significant nitrogen contents

■ % Carbon next to heteroatoms (C-O or C-N)  
▨ % Carbonyl carbon (C=O)  
▩ % Aromatic and/or olefinic carbon (C=C)  
□ % Aliphatic carbon (C-C)

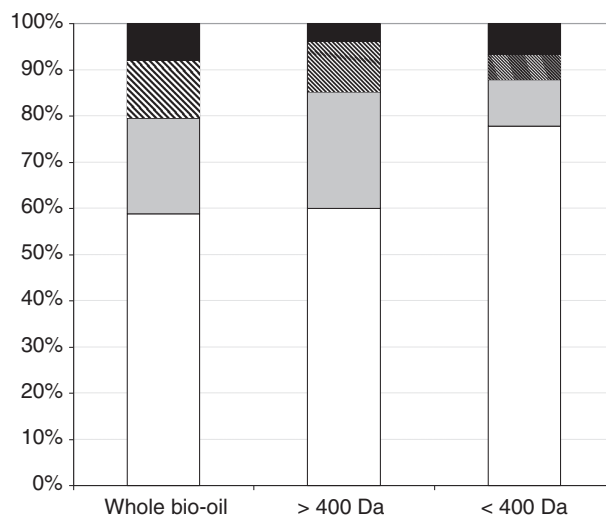

Figure 3

$^{13}\text{C}$  NMR analysis of the bio-oil (with no solids), the > 400 Da retentate and the < 400 Da permeate.

measured in water-insoluble fractions (Scholze *et al.*, 2001; Bayerbach and Meier, 2009). Concerning the second step of the membrane fractionation using a MWCO 220 Da membrane, no significant difference can be observed about elemental composition of the three concerned fractions (*i.e.* permeate < 400 Da, retentate enriched in > 220-400 Da and permeate < 220 Da).

#### $^{13}\text{C}$ NMR Analysis

The  $^{13}\text{C}$  NMR analyses were performed on the pre-filtrated bio-oil sample and on the fractions obtained from



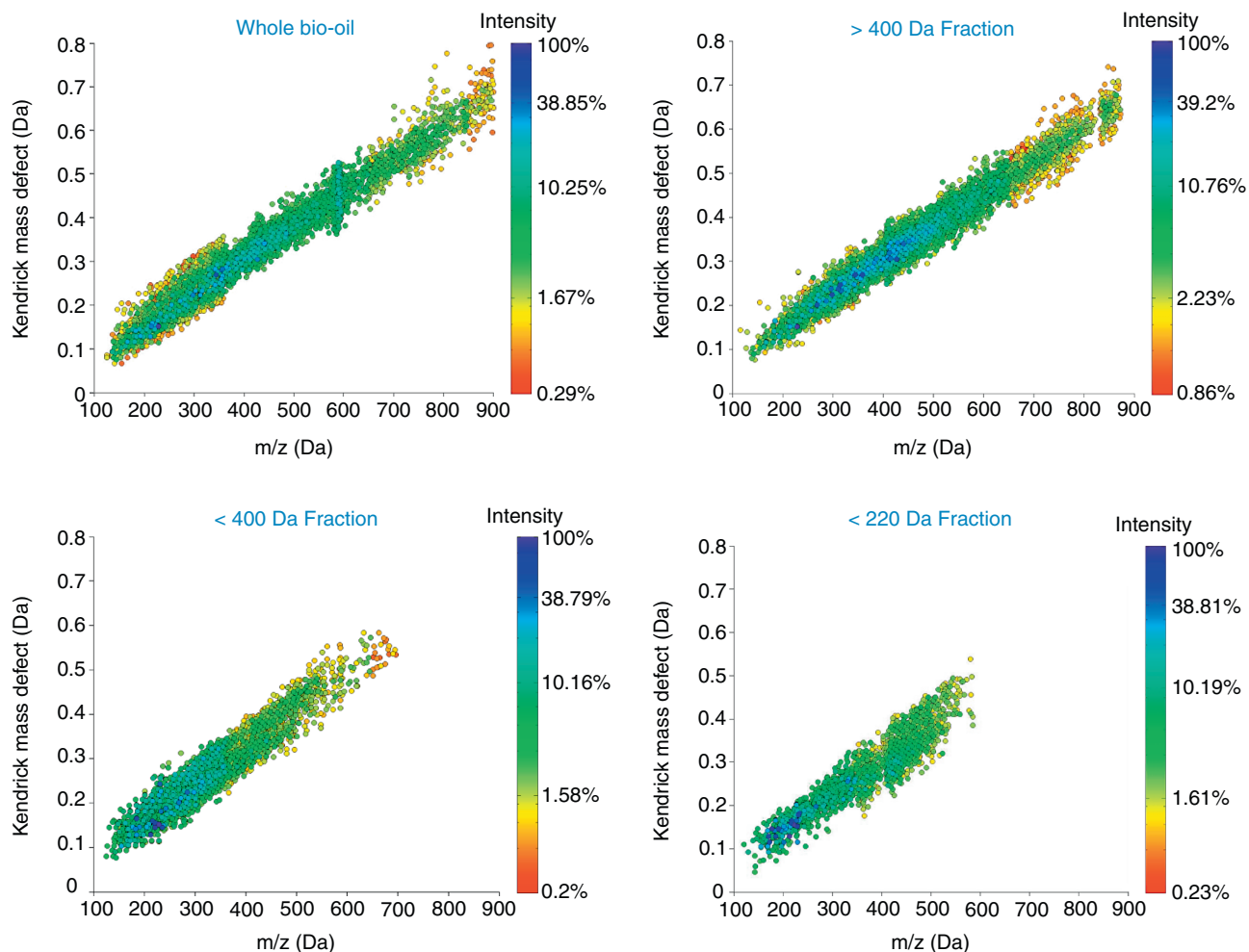

Figure 4

Kendrick diagrams from ESI(+)-FT-ICR/MS analysis of the bio-oil (with no solids), >400 Da retentate, <400 Da permeate and <220 Da permeate.

the first fractionation step using the MWCO 400 Da membrane. The  $^{13}\text{C}$  NMR method used in this work provides information about the following chemical families: carbonyl groups (esters, carboxylic acids, aldehydes and ketones), aromatic and/or olefinic carbon atoms, aliphatic carbon atoms and carbon atoms close to an oxygen or a nitrogen atom.

We can notice that the <400 Da fraction is more aliphatic than the >400 Da fraction, which is in accordance with the H/C ratios obtained by elemental analysis (Fig. 3). Regarding to heteroatoms bonding, the higher molecular weight concentrates more carbonyl groups whereas the <400 Da fraction has the highest proportions of C-O carbon type, which is in accordance with elemental analyses results.

#### FT-ICR/MS Analysis

The ESI(+)-FT-ICR/MS data obtained from the analysis of the bio-oil (with no solids) and its nanofiltration fractions can be illustrated as Kendrick diagrams (Fig. 4). Each horizontal row represents homologous series of compounds having the same chemical formula (heteroatoms) and same degree of unsaturation but different numbers of alkyl  $\text{CH}_2$  groups. Aromaticity increases with the Kendrick Mass Defect. The FT-ICR/MS results clearly highlight the impact of the bio-oil fractionation on the molecular weight distributions of <400 Da and <220 Da fractions. Compounds having molecular weight lower than 150 Da can not be detected in the FT-ICR/MS conditions used for this

study. Kendrick diagrams resulting from the bio-oil and its fractions exhibit a diagonal pattern, which is totally different from the spherical plots that can be usually observed for the Kendrick diagrams from petroleum products (Purcell *et al.*, 2010). The number of CH<sub>2</sub> groups is very limited for homologous series of compounds in the bio-oil while aromatic compounds are distributed over a large range. A large number of ions (more than one thousand) can be detected and identified by ESI(+)-FT-ICR/MS for each sample, which illustrates well the chemical complexity of such liquids.

### 3 INVESTIGATION OF FAST PYROLYSIS OIL ON CO-TREATMENT WITH A PETROLEUM ATMOSPHERIC GAS OIL

Different oxygen model compounds have been co-treated with a SRGO in order to determine the impact of these compounds on the quality of the gas oil after hydrotreating on a CoMo catalyst (Pinheiro *et al.*, 2009). The proportions of the oxygen compounds were adjusted in order to obtain a final mixture with 0.5%w/w of oxygen. Under operating conditions (CoMo catalyst,  $P_{tot} = 30\text{-}50$  MPa,  $T = 330^\circ\text{C}$ ,  $LHSV = 0.5\text{-}1.0$  h<sup>-1</sup>,  $H_2/HC_{outlet} = 240\text{-}400$  SL/L), the results showed that:

- oxygen compounds are completely hydrodeoxygenated at the reactor outlet;
- oxygen compounds that produce water by HDO such as alcohols, ketones or ethers did not inhibit the hydrotreatment reactions;
- oxygen compounds that produce CO/CO<sub>2</sub> by decarboxylation such as esters or carboxylic acids inhibited the hydrotreatment reactions. The inhibiting effect of the CO/CO<sub>2</sub> was then suspected.

Therefore, a second study has been performed in order to measure the impact of the presence of CO/CO<sub>2</sub> on the SRGO hydrotreatment using a CoMo catalyst (Pinheiro *et al.*, 2011). Same operating conditions have been tested as for the previous work, the oxygen compounds being just replaced by carbon monoxide or carbon dioxide injected in the inlet gas. The main results of this second work showed that:

- carbon monoxide and carbon dioxide have an inhibiting effect on the hydrotreatment reactions;
- the inhibiting effect observed in presence of esters or carboxylic acids in the first work is due to the CO/CO<sub>2</sub> formed by decarboxylation;
- CO and CO<sub>2</sub> are at the equilibrium of the Water Gas Shift reaction at the reactor outlet;
- CO and CO<sub>2</sub> are partially converted into methane by methanation at the reactor outlet.

In order to complete these two works, a new experiment is proposed in this study by mixing the AGO directly with the retentate enriched in > 220-400 Da.

### 3.1 Results

If the follow-up of the points 1 (SRGO alone), 2 (SRGO + ethanol) and 4 (SRGO alone) were performed without major difficulties, it was not the case for the point 3 (SRGO + ethanol + retentate enriched in > 220-400 Da). Indeed, the stability of the emulsion bio-oil/ethanol/SRGO was not perfect and it was necessary to mix continuously the feed tank during the experiment with a magnetic stirrer bar. Despite this difficulty, the four experiments have been carried out on the pilot unit and the main results are given in Table 5.

### 3.2 Discussion

The comparison between the point 1 (SRGO alone) and the point 2 (SRGO + ethanol) allows to conclude that the presence of ethanol, which is decomposed into water and ethane by HDO during the treatment, has no measurable impact on the catalytic performance. This result was expected and is in agreement with the study concerning the impact of several oxygen compounds on a SRGO hydrotreatment (Pinheiro *et al.*, 2009).

The second observation concerns the difference between the point 1 (SRGO alone before introduction of oxygen compounds) and the point 4 (SRGO alone after introduction of oxygen compounds). There is no significant difference between them in terms of hydrotreatment, which allows to consider that the catalyst deactivation is very low and insensitive to the presence of oxygen compounds in the feed.

Consequently the small differences of reactivity observed between the point 1 (SRGO alone) and the point 3 (SRGO + ethanol + retentate) are doubtless due to the presence of the retentate enriched in 220-400 Da. Indeed the presence of 2.4%w/w of retentate in the SR gas oil causes the increase of the sulfur content in the effluent from 308 to 373 wt ppm, as well as the increase of the nitrogen content from 9 to 12 wt ppm. The same conclusion for the aromatic carbon content is not as obvious as for sulfur or nitrogen, probably due to the high uncertainty observed on this type of analysis.

If an inhibiting effect is considered, previous works had shown that this inhibiting effect was attributed to the presence of carbon monoxide or dioxide produced by decarboxylation of the esters or carboxylic acids and not to the presence of the esters or carboxylic acids

TABLE 5  
Effluent characteristics after hydrotreating at 330°C (*T*), 5 MPa (*P<sub>tot</sub>*), 1 h<sup>-1</sup> (LHSV) and 400 SL/L (H<sub>2</sub>/HC<sub>outlet</sub>) on a CoMo catalyst

	Point 1	Point 2	Point 3	Point 4
Feed	SRGO	SRGO + 2.4%w/w EtOH	SRGO + 2.4%w/w EtOH + 2.4%w/w retentate	SRGO
HDS performance:				
Effluent S content	308 wt ppm	294 wt ppm	373 wt ppm	316 wt ppm
HDS	97.7%	97.8%	97.1%	97.7%
HDN performance:				
Effluent N content	9 wt ppm	9 wt ppm	12 wt ppm	10 wt ppm
HDN	93.0%	92.7%	90.6%	93.3%
HDCa performance:				
Effluent Ca content	10.2%	10.0%	9.8%	10.0%
HDCa	38.6%	39.8%	41.0%	39.8%

themselves. Consequently, it is important to evaluate the quantity of CO/CO<sub>2</sub> produced by decarboxylation.

As explained previously, the pilot unit was equipped with an online gas chromatography in order to determine the composition of the outlet gas coming from the high pressure separator. This GC apparatus, coupled with a gas counter, allows to calculate the molar flowrates of several hydrocarbons (methane, ethane, propane, butane, etc.) as well as CO and CO<sub>2</sub>. As expected, no CO and CO<sub>2</sub> were detected when SRGO, alone or mixed with ethanol, was injected in the unit. On the contrary, the introduction of the mixture SRGO + ethanol + retentate leads to the apparition of CO and CO<sub>2</sub> as well as an increase of the methane content in the outlet gas. The presence of CO/CO<sub>2</sub> is due to decarboxylation (or decarbonylation) of the esters and carboxylic acids as well as the equilibrated reaction of Water Gas Shift. The increase of the methane content is in turn the consequence of the partial conversion of the produced CO/CO<sub>2</sub> into methane in addition to the methane produced by cracking of the hydrocarbon compounds coming from the SRGO.

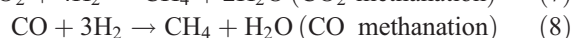
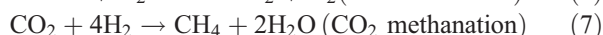
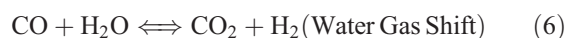

In order to estimate the total molar flowrate of CO/CO<sub>2</sub>/CH<sub>4</sub> produced by decarboxylation of the esters and carboxylic acids present in the retentate enriched in 220-400 Da, it is necessary to add the molar flowrates of CO and CO<sub>2</sub> (determined by gas chromatography) to the

TABLE 6  
Molar flowrates (mmol/h) of CO, CO<sub>2</sub> and CH<sub>4</sub> at the reactor outlet for the point 3 (SRGO + EtOH + retentate) hydrotreated at 330°C, 5 MPa and 1.0 h<sup>-1</sup>

	Molar flowrate at the reactor outlet (mmol/h)
CO	0.010
CO <sub>2</sub>	0.012
CH <sub>4</sub>	0.133
Sum	0.152

molar flowrate of CH<sub>4</sub> produced by methanation (determined by difference between the CH<sub>4</sub> molar flowrates when SRGO + ethanol + retentate is injected and when SRGO is injected alone). Table 6 gives the values for these different molar flowrates obtained with the point 3. The total molar flowrate for CO/CO<sub>2</sub>/CH<sub>4</sub> is 0.152 mmol/h.

Another solution to estimate the total molar flowrate of CO/CO<sub>2</sub>/CH<sub>4</sub> produced by decarboxylation is to calculate the quantity of esters and carboxylic acids which are present in the retentate enriched in 220-400 Da. The mass flowrate of feed is equal to 3.4 g/h. The fraction of retentate being of 2.4%w/w, the mass flowrate of retentate is calculated at 0.081 g/h. We assumed that esters were not present in this type of product. Carboxylic acids content can be measured by KOH titration, even if this method is not completely selective for the organic acids. Therefore, 5.94 mmol of acids are titrated

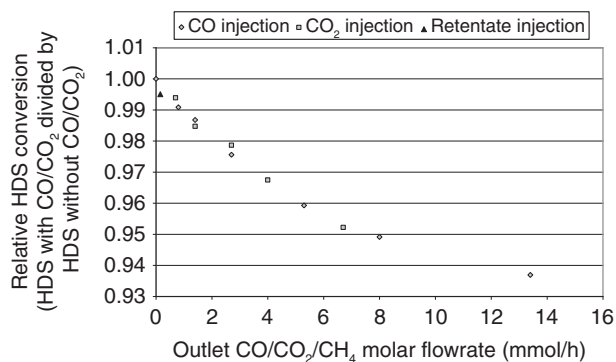

Figure 5

Impact of CO, CO<sub>2</sub> and retentate enriched in > 220-400 Da on HDS conversion (CoMo,  $T = 330^{\circ}\text{C}$ ,  $P_{tot} = 5 \text{ MPa}$ ,  $\text{LHSV} = 1.0 \text{ h}^{-1}$ ).

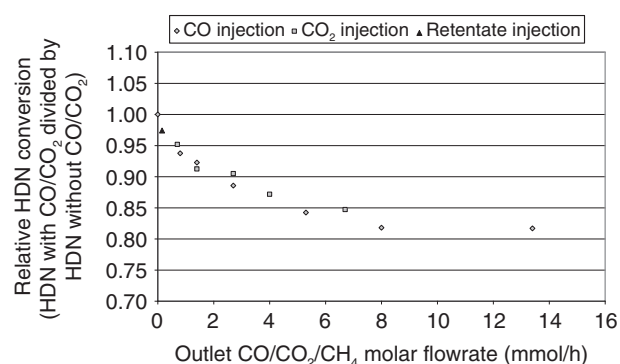

Figure 6

Impact of CO, CO<sub>2</sub> and retentate enriched in > 220-400 Da on HDN conversion (CoMo,  $T = 330^{\circ}\text{C}$ ,  $P_{tot} = 5 \text{ MPa}$ ,  $\text{LHSV} = 1.0 \text{ h}^{-1}$ ).

in 1 g of sample. Consequently the molar flowrate of acids in the pilot unit was equal to 0.48 mmol/h. Assuming, from our previous results using the same catalyst and operating conditions, that the selectivity of the decarboxylation pathway of 42 mol% (Pinheiro *et al.*, 2009), the molar flowrate of CO/CO<sub>2</sub>/CH<sub>4</sub> can be estimated at 0.20 mmol/h, which is slightly higher than the value of 0.152 mmol/h obtained from gas chromatography analysis. The probable reason of this difference is due to some retentate deposits (especially before the valves and the filters) which decrease the flowrate of retentate actually injected in the reactor and consequently the flowrate of potential carboxylic acids.

It is now interesting to compare the inhibiting effect on the hydrotreatment of the SRGO when it is mixed with the retentate and when it is hydrotreated with injection of an equivalent amount (0.152 mmol/h) of CO or CO<sub>2</sub>. The objective of this comparison is to determine if the inhibiting effect observed when the retentate is incorporated into the SRGO is due to the CO/CO<sub>2</sub> produced by decarboxylation of the carboxylic acids present in the retentate, or whether directly due to the oxygen compounds present in the retentate. Figure 5 and Figure 6, redrawn from (Pinheiro *et al.*, 2011), give the relative evolution of the HDS and HDN conversions respectively (HDX in presence of CO or CO<sub>2</sub> divided by HDX without CO/CO<sub>2</sub>,  $X = \text{S or N}$ ) as a function of the molar flowrate of CO/CO<sub>2</sub>/CH<sub>4</sub> at the reactor outlet. The figures show there is no difference between CO and CO<sub>2</sub> in terms of inhibition. The explanation is that the Water Gas Shift reaction is fast under our operating conditions (CoMo, 330°C, 5 MPa and 1 h<sup>-1</sup>) and the equilibrium between CO and CO<sub>2</sub> is reached very rapidly in the first part of the reactor. The choice of injecting CO

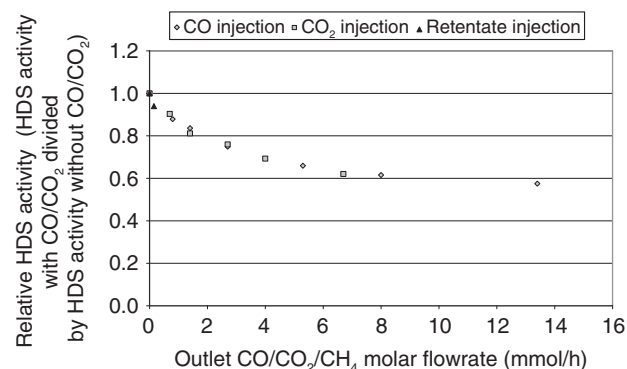

Figure 7

Impact of CO, CO<sub>2</sub> and retentate enriched in > 220-400 Da on HDS activity (CoMo,  $T = 330^{\circ}\text{C}$ ,  $P_{tot} = 5 \text{ MPa}$ ,  $\text{LHSV} = 1.0 \text{ h}^{-1}$ ).

or CO<sub>2</sub> has consequently no impact on the final inhibition of the hydrotreatment reactions.

Another way to represent the effect of CO and CO<sub>2</sub> on the hydrotreating reactions is to give the evolution of the relative catalytic activity for HDS and HDN reactions as function of the molar flowrate of CO or CO<sub>2</sub> (Fig. 7, 8). The catalytic activity can be calculated with the following pseudo-order equation if the operating conditions (temperature, pressure and LHSV) are constant:

$$a_X \propto \left[ \left( \frac{1}{X_{outlet}} \right)^{n_X-1} - \left( \frac{1}{X_{inlet}} \right)^{n_X-1} \right] \quad (9)$$

where  $a_X$ : catalytic activity for HDS ( $X = \text{S}$ ) or HDN ( $X = \text{N}$ ) reaction;  $X_{inlet}$ : sulfur or nitrogen content in the feed (expressed in wt ppm);  $X_{outlet}$ : sulfur or nitrogen content in the hydrotreated effluent (expressed in wt ppm);

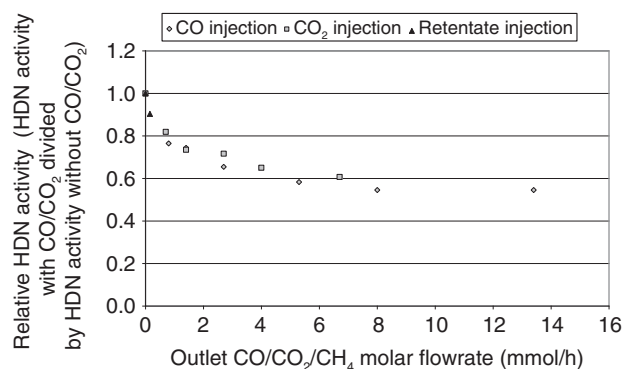

Figure 8

Impact of CO, CO<sub>2</sub> and retentate enriched in >220-400 Da on HDN activity (CoMo,  $T = 330^{\circ}\text{C}$ ,  $P_{tot} = 5 \text{ MPa}$ ,  $\text{LHSV} = 1.0 \text{ h}^{-1}$ ).

$n_X$ : global reaction order for HDS ( $n_S = 1.1$ ) or HDN ( $n_N = 0.9$ ).

The global reaction orders for HDS and HDN have been calculated using some extra experiments which are not presented in this article. The results in terms of relative catalytic activity show again a very strong inhibiting effect of CO/CO<sub>2</sub> with a decrease of 50% of the HDS activity (Fig. 7) and HDN activity (Fig. 8) when the molar flowrate of CO/CO<sub>2</sub> goes from 0 to 14 mmol/h. Moreover the comparison of both figures shows that the inhibition is the same for the HDS and HDN reactions.

When the experimental point using SRGO mixed with the retentate enriched in 220-400 Da is placed in the same graphs (Fig. 5, 6), we can conclude that the inhibition due to the retentate is the same as for an hypothetical experimental point where 0.152 mmol/h of CO or CO<sub>2</sub> would be injected. In this case, the catalytic activity is decreased by 10%. That confirms that the oxygen compounds are quickly converted under these conditions and their products of reaction, CO and CO<sub>2</sub>, are the true hydrotreating inhibitors.

Unfortunately the experiments proposed in this article do not allow to distinguish the specific inhibiting effect of CO compared to CO<sub>2</sub> on hydrotreating reactions. Indeed, in the studied operating conditions, CO and CO<sub>2</sub> are always at the thermodynamic equilibrium of Water Gas Shift. In order to observe separately the effect of the two compounds, it will be necessary to perform some experiments at very low conversion in order to get away from the equilibrium that seems difficult when the hydrotreating experiments are carried out directly

with real Atmospheric Gas Oils. In the literature, CO is known to act selectively on the hydrogenation/hydrodesulfurization pathways of FCC gasolines (Ghosh *et al.*, 2009). For example, Pelardy *et al.* (2010) showed experimentally the inhibiting effect of CO on the conversion of 2-MethylThiophene (2MT) and 2,3-DiMethylBut-2-eNe (23DMB2N) in FCC gasoline hydrotreating conditions (CoMo/Al<sub>2</sub>O<sub>3</sub>, 2 MPa; 250°C; various contact times). These results were then validated by DFT calculations that confirm that CO adsorption is strongly favored on the S- and M-edge sites of the CoMo catalyst compared to 2MT and 23DMB2N adsorptions and explain the strong inhibiting effect of CO on the 23DMB2N hydrogenation and 2MT hydrodesulfurization. However, if the inhibiting effect of CO is confirmed by these different works, there is no similar study on the inhibiting effect of the carbon dioxide on the hydrotreating reactions in the best of our knowledge. Concluding on the relative effect of CO and CO<sub>2</sub> on Atmospheric Gas Oil hydrotreating is thus impossible in this work, even if CO is probably the most inhibitor of both of them.

## CONCLUSION

This article concludes a series of studies concerning on the effect of oxygen compounds on a conventional gas oil hydrotreatment. The underlying idea is to use existent industrial units of Atmospheric Gas Oil (AGO) hydrotreatment in order to co-treat oxygen products coming from biomass or coal. The objective is then to deoxygenate these additional products while avoiding a performance reduction of the unit in terms of HydroDeSulfurization (HDS), HydroDeNitrogenation (HDN) and aromatics hydrogenation (HDC<sub>a</sub>).

The first study has shown that oxygen model compounds which produce water by HDO (alcohols, ketones, ethers) have no impact on the performance of the GO hydrotreatment in conventional deep HDS operating conditions (CoMo, 330°C, 5 MPa, 1 h<sup>-1</sup>). However, the oxygen model compounds which decompose by decarboxylation and form CO or CO<sub>2</sub> (esters, carboxylic acids) inhibit strongly the hydrotreating reactions such as HDS, HDN and HDC<sub>a</sub>. The inhibiting effect of CO/CO<sub>2</sub> was therefore suspected but not confirmed (Pinheiro *et al.*, 2009).

A second study was then proposed in order to estimate directly the impact of the carbon monoxide and the carbon dioxide on the SRGO hydrotreatment. Several experiments were performed by injection of different quantities of CO or CO<sub>2</sub> in the inlet gas in the same conditions as for the first work. The results have shown that CO and CO<sub>2</sub> are at the thermodynamic equilibrium of

the Water Gas Shift reaction and that a part of them is transformed into methane by methanation reaction. The inhibiting effect of CO/CO<sub>2</sub> observed is in perfect relation with the inhibiting effect detected for the ester and the acid used in the first study. These results allowed to confirm that the inhibiting effects observed in presence of carboxylic acids and esters are due to the decarboxylation (decarbonylation) products, CO and CO<sub>2</sub>, and not to the oxygenated reactants themselves.

Finally, this last study allows to valid the coprocessing route by co-treating a gas oil and a oxygen product liquid coming from flash pyrolysis of biomass. The used bio-oil has firstly been separated into four fractions by membrane fractionation at 220 Da and 400 Da. Each of these fractions has been analyzed by different analytical techniques such as size-exclusion chromatography, elemental analyses, <sup>13</sup>C NMR and FT-ICR/MS. The retentate enriched in 220-400 Da has been mixed with a SRGO in proportion of 2.4%w/w in presence of ethanol to improve the emulsion stability. The obtained mixture has been hydro-treated in a 4 cm<sup>3</sup> pilot unit at 330°C and 5 MPa by using a conventional CoMo/Al<sub>2</sub>O<sub>3</sub> catalyst. The liquid hourly space velocity was 1.0 h<sup>-1</sup> and the ratio H<sub>2</sub>/HC at the reactor outlet was 400 SL/L. Despite some experimental difficulties mainly due to the emulsion stability, the hydrotreatment has been successful and an inhibition has been observed on the HDS, HDN and HDC<sub>a</sub> reactions in presence of the retentate. The measurement of the CO/CO<sub>2</sub>/CH<sub>4</sub> molar flowrate at the reactor outlet has allowed to confirm that the inhibition was due to the presence of CO and CO<sub>2</sub> formed during the reaction and not due to the oxygen compounds present in the retentate themselves.

These series of works show the interest to co-treat Atmospheric Gas Oils with oxygen containing products such as bio-oils or coal hydroliquefied liquids. However, in order to limit the inhibition effects on the hydrotreatment, it is important to limit the presence of CO/CO<sub>2</sub>, for example by eliminating carboxylic acids of the oxygen containing products before their introduction in the hydrotreating unit or by selecting new catalysts which are less sensitive to the presence of CO/CO<sub>2</sub>, or which decrease the decarboxylation pathway in favor of the dehydration one.

## REFERENCES

- Bayerbach R., Meier D. (2009) Characterization of the water-insoluble fraction from fast pyrolysis liquids (pyrolytic lignin). Part IV: Structure elucidation of oligomeric molecules, *J. Anal. Appl. Pyrolysis* **85**, 1-2, 98-107.
- Bouvier C., Romero Y., Richard F., Brunet S. (2011) Effect of H<sub>2</sub>S and CO on the transformation of 2-ethylphenol as a model compound of bio-crude over sulfided Mo-based catalysts: propositions of promoted active sites for deoxygenation pathways based on an experimental study, *Green Chem.* **13**, 9, 2441-2451.
- Bridgewater T. (2007) Biomass Pyrolysis, *Biomass Bioenergy* **31**, 4, VII-XVIII.
- Bui V.N., Toussaint G., Laurenti D., Mirodatos C., Geantet C. (2009) Co-processing of pyrolysis bio-oils and gas oil for new generation of bio-fuels: hydrodeoxygenation of guaiacol and SRGO mixed feed, *Catal. Today* **143**, 172.
- Demirbas M.F. (2007) Progress and recent trends in biofuels, *Progr. Energ. Combust. Sci.* **33**, 1, 1-18.
- Demirbas M.F., Balat M. (2007) Biomass pyrolysis for liquid fuels and chemicals: A review, *J. Sci. Ind. Res.* **66**, 10, 797-804.
- Elliot D.C. (2007) Historical developments in hydroprocessing bio-oils, *Energy Fuels* **21**, 3, 1792-1815.
- Furimsky E. (2000) Catalytic hydrodeoxygenation, *Appl. Catal. A: Gen.* **199**, 2, 147-190.
- Ghosh P., Andrews A.T., Quann R.J., Halbert T.R. (2009) Detailed Kinetic Model for the Hydro-desulfurization of FCC Naphtha, *Energy Fuels* **23**, 5743-5759.
- Hubert G.W., Corma A. (2007) Synergies between bio- and oil refineries for the production of fuels from biomass, *Angew. Chem. Int. Edit.* **46**, 38, 7184-7201.
- Kokayeff P. (2005) *Hydrocarbon Eng.* **10**, 53.
- de Miguel Mercader F., Groeneveld M.J., Kersten S.R.A., Geantet C., Toussaint G., Way N.W.J., Schaverien C.J., Hogendoorn K.J.A. (2011) Hydrodeoxygenation of pyrolysis oil fractions: process understanding and quality assessment through co-processing in refinery units, *Energy Environ. Sci.* **4**, 985-997.
- Omaïs B., Charon N., Courtiade M., Ponthus J., Thiébaud D. (2013) A novel analytical approach for oxygen speciation in coal-derived liquids, *Fuel* **104**, 805-812.
- Pelardy F., Dupont C., Fontaine C., Devers E., Daudin A., Bertoncini F., Raybaud P., Brunet S. (2010) Impact of CO on the transformation of a model FCC gasoline over Co-MoS/Al<sub>2</sub>O<sub>3</sub> catalysts: A combined kinetic and DFT approach, *Appl. Catal. B: Env.* **97**, 3-4, 323-332.
- Philippe M., Richard F., Hudebine D., Brunet S. (2010) Inhibiting effect of oxygenated model compounds on the HDS of dibenzothiophenes over CoMoP/Al<sub>2</sub>O<sub>3</sub> catalyst, *Appl. Catal. A: Gen.* **383**, 1-2, 14-23.
- Pinheiro A., Hudebine D., Dupassieux N., Geantet C. (2009) Impact of Oxygenated Compounds from Lignocellulosic Biomass Pyrolysis Oils on Gas Oil Hydrotreatment, *Energy Fuels* **23**, 1, 1007-1014.
- Pinheiro A., Dupassieux N., Hudebine D., Geantet C. (2011) Impact of the Presence of Carbon Monoxide and Carbon Dioxide on Gas Oil Hydrotreatment: Investigation on Liquids from Biomass Cotreatment with Petroleum Cuts, *Energy Fuels* **25**, 1, 804-812.
- Purcell J.M., Merdrignac I., Rodgers R.P., Marshall A.G., Gauthier T., Guibard I. (2010) Stepwise Structural Characterization of Asphaltenes during Deep Hydroconversion Processes Determined by Atmospheric Pressure Photoionization (APPI) Fourier Transform Ion Cyclotron Resonance (FT-ICR) Mass Spectrometry, *Energy Fuels* **24**, 4, 2257-2265.

Scholze B., Hanser C., Meier D. (2001) Characterization of the water-insoluble fraction from fast pyrolysis liquids (pyrolytic lignin). Part II. GPC, carbonyl groups and  $^{13}\text{C}$ -NMR, *J. Anal. Appl. Pyrolysis* **58-59**, 387-400.

Tailleur R.G. (2006) Diesel upgrading into a low emissions fuel, *Fuel Process. Technol.* **87**, 9, 759-767.

Zhang Q., Chang J., Wang T.J., Xu Y. (2007) Review of biomass pyrolysis oil properties and upgrading research, *Energy Convers. Manage.* **48**, 1, 87-92.

*Manuscript accepted in January 2013*

*Published online in September 2013*

Copyright © 2013 IFP Energies nouvelles

Permission to make digital or hard copies of part or all of this work for personal or classroom use is granted without fee provided that copies are not made or distributed for profit or commercial advantage and that copies bear this notice and the full citation on the first page. Copyrights for components of this work owned by others than IFP Energies nouvelles must be honored. Abstracting with credit is permitted. To copy otherwise, to republish, to post on servers, or to redistribute to lists, requires prior specific permission and/or a fee: Request permission from Information Mission, IFP Energies nouvelles, fax. +33 1 47 52 70 96, or [revueogst@ifpen.fr](mailto:revueogst@ifpen.fr).