



HAL
open science

New Developments of the NADI (TM) Concept to Improve Operating Range, Exhaust Emissions and Noise

B. Gatellier, A. Ranini, M. Castagné

► To cite this version:

B. Gatellier, A. Ranini, M. Castagné. New Developments of the NADI (TM) Concept to Improve Operating Range, Exhaust Emissions and Noise. Oil & Gas Science and Technology - Revue d'IFP Energies nouvelles, 2006, 61 (1), pp.7-23. 10.2516/ogst:2006001x . hal-02005782

HAL Id: hal-02005782

<https://ifp.hal.science/hal-02005782v1>

Submitted on 4 Feb 2019

HAL is a multi-disciplinary open access archive for the deposit and dissemination of scientific research documents, whether they are published or not. The documents may come from teaching and research institutions in France or abroad, or from public or private research centers.

L'archive ouverte pluridisciplinaire **HAL**, est destinée au dépôt et à la diffusion de documents scientifiques de niveau recherche, publiés ou non, émanant des établissements d'enseignement et de recherche français ou étrangers, des laboratoires publics ou privés.

New Developments of the NADI™ Concept to Improve Operating Range, Exhaust Emissions and Noise

B. Gatellier¹, A. Ranini¹ and M. Castagné¹

¹ Institut français du pétrole, 1 et 4, avenue de Bois-Préau, 92852 Rueil-Malmaison Cedex - France
e-mail: bertrand.gatellier@ifp.fr - alain.ranini@ifp.fr - laurent.mathieu@ifp.fr - michel.castagné@ifp.fr

Résumé — Nouveaux développements du concept NADI™ en vue d'améliorer la zone de fonctionnement, les émissions de polluants et le bruit — Pour répondre aux enjeux du moteur Diesel destiné aux véhicules particuliers, l'IFP a développé un système de combustion innovant capable d'atteindre des émissions de particules et d'oxydes d'azote pratiquement nulles aux charges partielles tout en maintenant les performances d'un moteur Diesel conventionnel, notamment en terme de puissance et de couple. Ce moteur bi-mode, dénommé NADI™ (pour Narrow Angle Direct Injection) applique le principe de la combustion à charge homogène aux charges partielles pour fortement réduire les émissions de polluants et bascule vers un mode de combustion plus conventionnel aux charges plus élevées, notamment à pleine charge pour atteindre les performances attendues. Ce papier présente les derniers développements de ce concept en terme d'architecture (système de combustion, boucle d'air, etc.), de calibration des paramètres moteur (multi-injections, EGR, etc.) et de stratégies de contrôle avancées (observateur, contrôleur multi-variables) en s'appuyant sur des essais obtenus sur monocylindre et multi-cylindre de 2,2 l de cylindrée. Une simulation sur véhicule de ces résultats confirme le potentiel de cette technologie pour atteindre, sur un véhicule de 1810 kg, les plus sévères émissions d'oxydes d'azote proposées par l'UBA comme future norme EURO V (0,08 g/km).

Abstract — New Developments of the NADI™ Concept to Improve Operating Range, Exhaust Emissions and Noise — As an answer to challenges the Diesel engine is facing, IFP has developed a combustion system able to reach near zero particulate and NOx emissions while maintaining performance standards of the D.I Diesel engines, especially in terms of output power and torque. This "dual mode" engine application called NADI™ (Narrow Angle Direct Injection) applies Homogeneous Charge Compression Ignition at part load and switches to conventional Diesel combustion to reach high and full load requirements. This paper presents the latest development of this concept, based on results obtained on a single cylinder engine as well as on a 2.2 l multi-cylinder engine, in term of hardware (combustion system, air loop, etc.), parameter settings (multiple injection, EGR, etc.) and advanced control strategies including observer and multivariable controller. Based on simulation, the results show a large potential for the technology to reach, on a 1810 kg class vehicle, the most stringent emission levels proposed by the UBA (0.08 g/km of NOx) as future EURO V standards.

INTRODUCTION

The agreement between the ACEA and the European Parliament to reduce the fleet consumption of new passenger cars to 140 g of CO₂ per kilometre in 2008 and the more and more stringent regulation of emissions represent a great challenge. The Diesel engine is one of the best candidates facing CO₂ reduction and its market share will probably increase further over the next few years. However, fuel efficient combustion produces high NO_x emissions. Despite the impressive progress made in the last decade, the Diesel engine is still facing the well known NO_x and particulate trade-off [9]. Last July, UBA proposed for the regulation of emissions after EURO 4 a NO_x/particulate emission of 0.08/0.0025 g/km [6]. This represents a NO_x/particulate reduction of 68% and 90% respectively. It is obvious that such limits will require new advanced technologies and/or new combustion processes.

As an answer to this challenge, a combined NO_x/particulate after-treatment solution could be found but with some drawbacks in terms of complexity, robustness, fuel dependency, infrastructure and then cost.

An alternative would be to apply new combustion processes efficient enough to solve the NO_x/CO₂ dilemma. Different approaches have been the subject of R&D work for a number of years in order to achieve low temperature combustion avoiding the formation of NO_x and in some cases the formation of particulate [1] to [9]. However, applying such new combustion process to engines involves some difficulties:

- Mixture preparation: the main problems are to avoid wall impingement and to promote fuel vaporisation and air mixing, so as to limit particulate and HC emissions, and to prevent oil dilution.
- Operating range: at high load, operation at high Fuel/Air equivalence ratio is limited by combustion stability, excessive heat release rate, knock and noise.
- Control of combustion: it is the key point in highly premixed combustion, especially to extend the operating range and power output.

Since 2000, IFP has been working to solve these problems and has developed the NADITM (Narrow Angle Direct Injection) concept which is a dual mode engine, using highly premixed combustion at low and medium loads and conventional Diesel combustion at high and full loads [7-9].

The first part of this paper, based on modelling and single cylinder engine testing, describes the main specifications required by engines equipped with such a concept to perform a highly premixed combustion (HPC) operating range as wide as possible and to reach the future standard performances at full load.

The second part presents an application of the NADITM concept to a 2.2 l multi-cylinder engine. The test-bench results are given at full load in terms of maximum output

power and torque level. The results at part load mainly concern the HPC mode operating range featuring very low NO_x emissions.

The third part deals with the engine control development. First, the development process is described in terms of tools which are used. Then, development of strategies for NADITM engine control relative to air loop, fuel and combustion control, is explained.

1 THE NADI CONCEPT OVERVIEW

This part of the paper presents the main topics of the NADITM concept in terms of combustion system, fuel injection system and air loop circuit.

1.1 Combustion System

To overcome limitations in power output, a “dual mode” engine was developed, using highly premixed combustion (HPC) at low and medium loads and conventional Diesel combustion at high loads (with injection close to TDC). This means that the combustion system should be able to switch between the two combustion modes.

1.1.1 Highly Premixed Combustion Demand

It is important to properly mix fuel and air before starting combustion. As a lot of works have pointed out that port fuel injection drawbacks are a bar to putting such engines into production, our first idea was to find a good combustion system allowing HPC combustion using the common rail fuel injection system which can make multiple injections with conventional injector nozzles. The choice of a narrow spray cone angle was made to allow early or late injection timing to promote air and fuel mixing while limiting fuel-wall wetting especially on the cylinder liner. Typical NADITM cone angle values are between [50°, 100°], compared to [145°, 155°] for the conventional Diesel combustion system. As the injector spray and the piston interact, computation was made to improve air and fuel mixing, also taking into account the air motion. It was demonstrated that piston/spray interaction is the first order parameter. The engine compression ratio has an influence on the auto-ignition phase of the combustion. As a reduction of compression ratio prolongs the air/fuel mixing process before the combustion, a compression ratio below or equal to 16:1 was chosen at the early stage of this development.

1.1.2 Conventional Combustion Demand

The first challenge was to make a proper transport and mixing with air of the fuel injected inside the piston bowl using a narrow cone angle. The idea was to adapt the piston bowl geometry in order to improve air and fuel mixing and so to reduce smoke. For this purpose, we used the IFP

approach based on the use of CFD tools combined with development work done with an operating engine. In Figure 1, a graph shows the computed output power against burned mass fraction (BMF) just before the exhaust valve opening. After few iterations, some combustion chambers, associated with nozzle and swirl definition adapted to narrow cone angle, were defined. It was also shown that not appropriated piston bowl geometry led to very uncompleted combustion and high smoke levels.

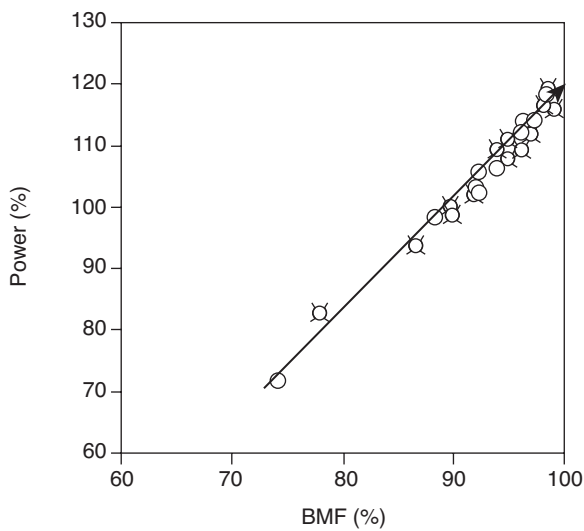

Figure 1
CFD results at 4000 rpm, full load.

First of all, the bowl dome was modified so as to properly guide the fuel spray to the bowl circumference. In addition the re-entrant shape of the piston bowl was optimized so as to allow the vaporized fuel to reach the air in the squish area. After a few iterations, some combustion chambers, associated with nozzles (number of holes) and swirl definitions, adapted to the narrow spray cone angle, were defined. It was found that such combustion system requires a low in-cylinder swirl level, which is an advantage for the cylinder head efficiency. In order to highlight the specificity of the NADI combustion system, Figure 2 shows the combustion process at 4000 rpm, full load, with a conventional combustion system (bowl and nozzle geometry) and with the NADI™ concept. The fuel-air mixture is represented in different color levels that depend on the lambda value: the fuel droplets in black, the vaporized fuel in light grey or red and the air in dark grey or blue.

With the conventional combustion system, the fuel is injected towards the bowl periphery. Due to fuel/wall interaction, the majority of the fuel is sent to the centre of the bowl, mixes with air and burns. Some fuel mixes with air and burns in the squish area. With the NADI™ concept, the fuel is injected at the centre of the combustion piston bowl. Due to fuel/wall interaction, vapour fuel is transported to the piston bowl periphery, mixes with air and burns. It should be noted that the liquid fuel never reach piston walls.

Single cylinder results: Tests made on single cylinder engines validated the NADI™ combustion because it solves the NO_x/CO₂ dilemma and meets the future power and torque output requirements. As described later on and more deeply in [7], thanks to an appropriate multiple staged injection strategy the initial results already published were

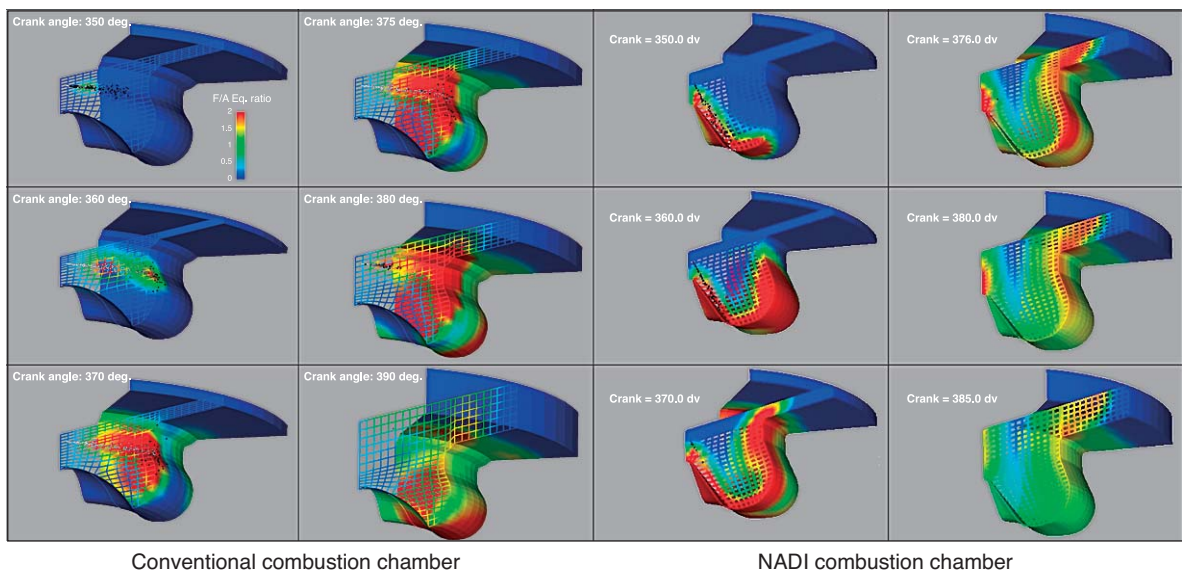

Figure 2
Computed combustion process at 4000 rpm, full load.

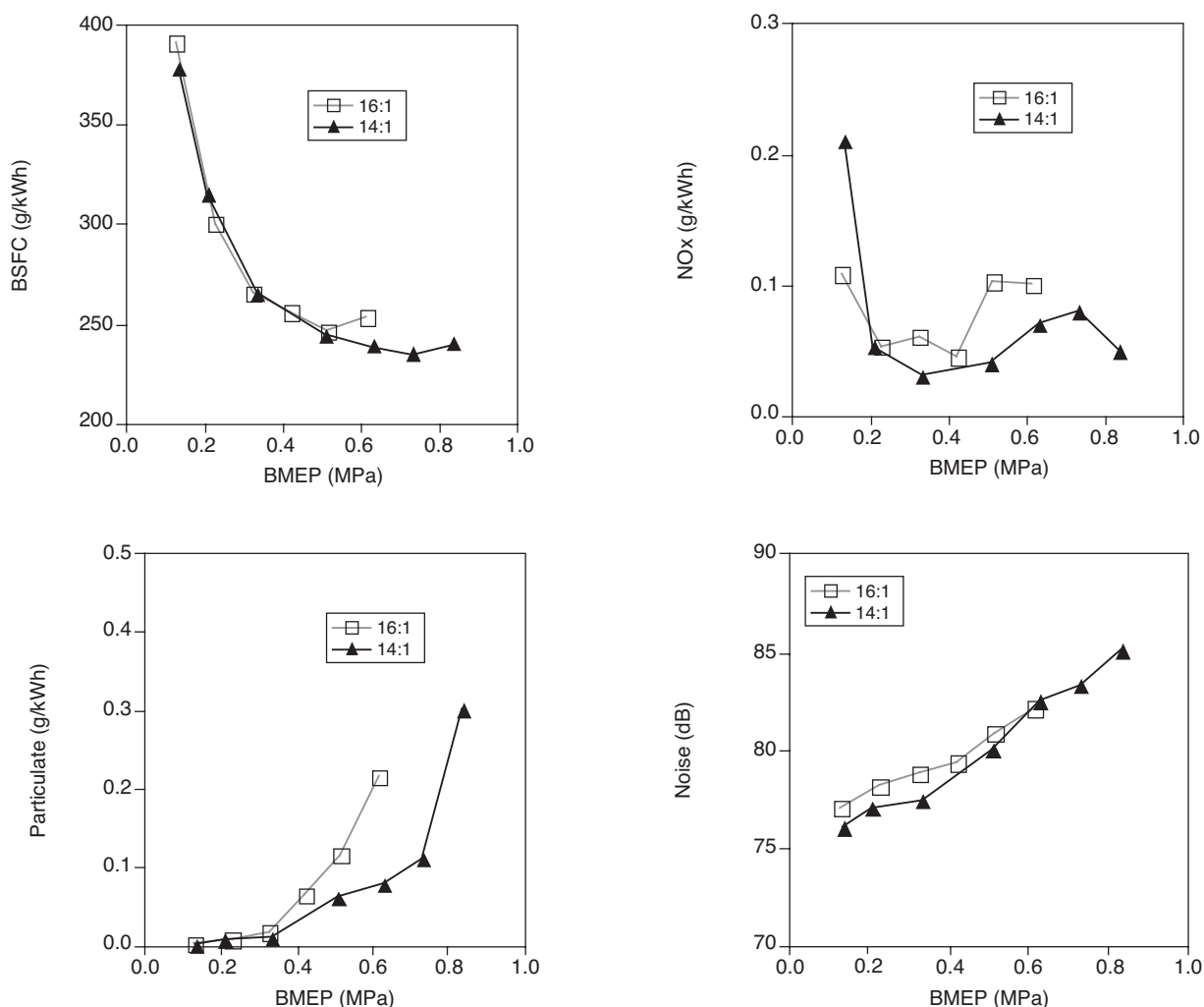

Figure 3

Compression ratio effect on engine results at part load, 1500 rpm.

improved regarding the “near zero NOx” operating range, exhaust emissions and combustion noise. In addition, this experimental single cylinder engine work showed significant advantages of reducing the compression ratio value. The results obtained on the same engine (bore and stroke) at 1500 and 2500 rpm and presented in the following figures highlight improvements obtained by the 14:1 value compared to 16:1 in terms of HPC and conventional combustion. At part load, using the HPC combustion, “near zero NOx” operating range, fuel consumption, other pollutant emissions and combustion noise are improved (Figs 3 and 4).

At full load, using conventional combustion, the compression ratio of 14:1 allows a significant increase in output torque and power with values reaching respectively 180 Nm/l and 60 kW/l compared to 150 Nm/l and 50 kW/l obtained with the compression ratio of 16:1, as is illustrated in Figure 5. These results were obtained with the same

limiting factors such as smoke, maximum in-cylinder pressure and exhaust temperature.

Combustion system definition for multi-cylinder engine testing: One of the main drawbacks of the compression ratio reduction is cold start and engine running stability. However, taking into account the up-coming improvements in technology in this field¹, a NADI™ combustion system with a compression ratio of 14:1 was selected for our multi-cylinder engine demonstrator. Further works are already planned to take into account the specificity of the NADI combustion system in order to find the appropriated spray/glow plug impingement with a 50-100° injector cone angle. One idea could be to use the injected spray momentum to move fuel toward the glow plug using the specific piston shape.

(1) New glow plugs, high speed starter, electrical air heater, etc.

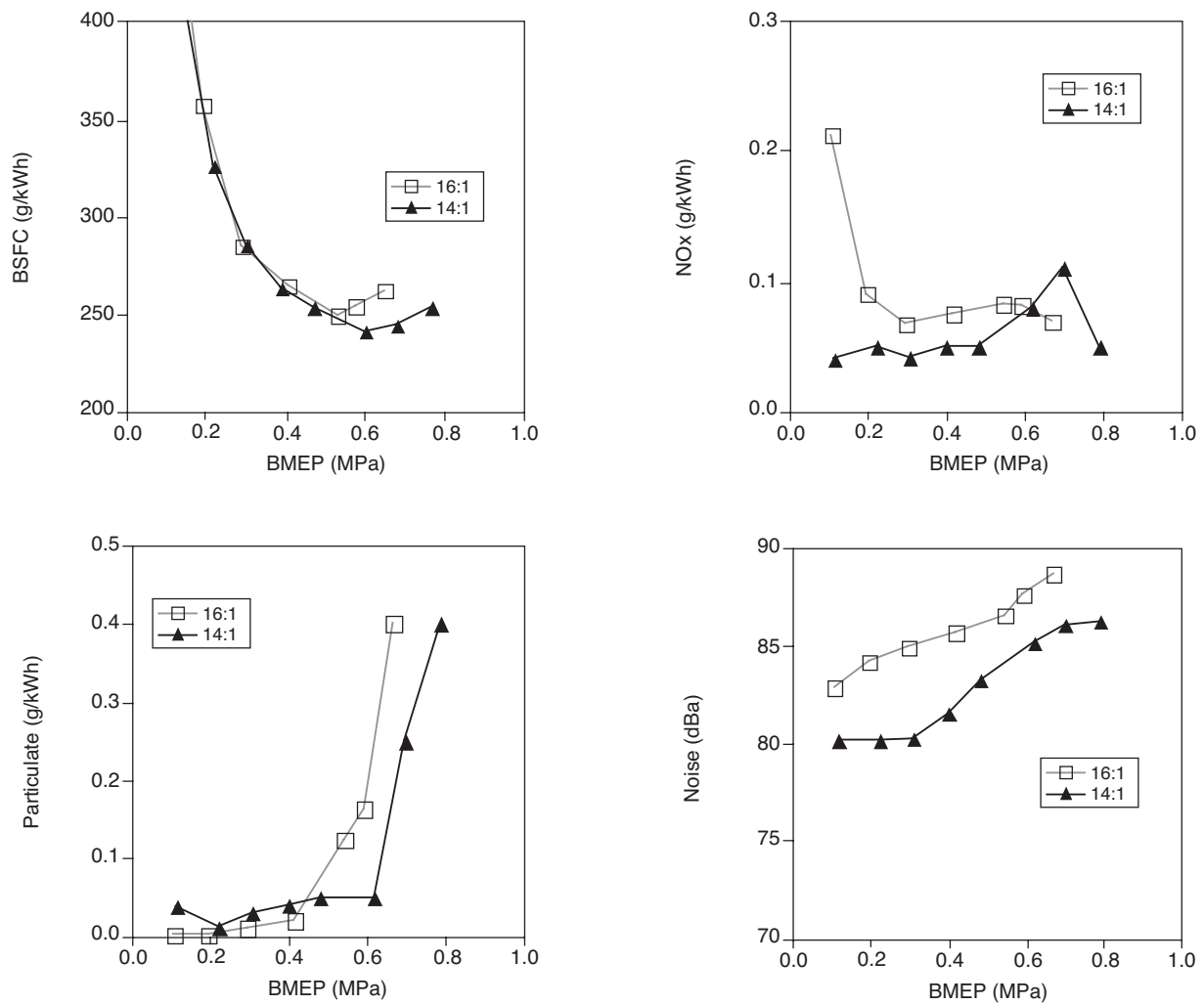

Figure 4
Compression ratio effect on engine results at part load, 2500 rpm.

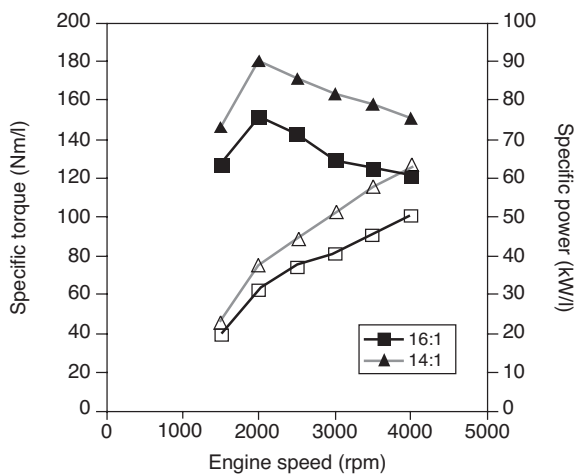

Figure 5
Compression ratio effect on engine results at full load.

1.2 Fuel Injection System

The NADI™ concept is based on the use of multiple injection strategies depending on engine load and speed in order to control the combustion according to the agreed targets.

At low engine load, early injections are helpful to obtain a good mix of the fuel with the air before the combustion in order to achieve near zero NOx and particulate emissions with a good fuel consumption as well as low combustion noise. The injection settings are calibrated to reduce the unburned fuel (HC and CO) and to avoid any methane emissions. As Figure 6 shows, it is possible to achieve this target by splitting the injected quantity into two or three times. So, the minimum injected quantity capability of the fuel injection system is an important parameter.

When engine load increases, early injection strategy allows near zero NOx and particulate emissions to be

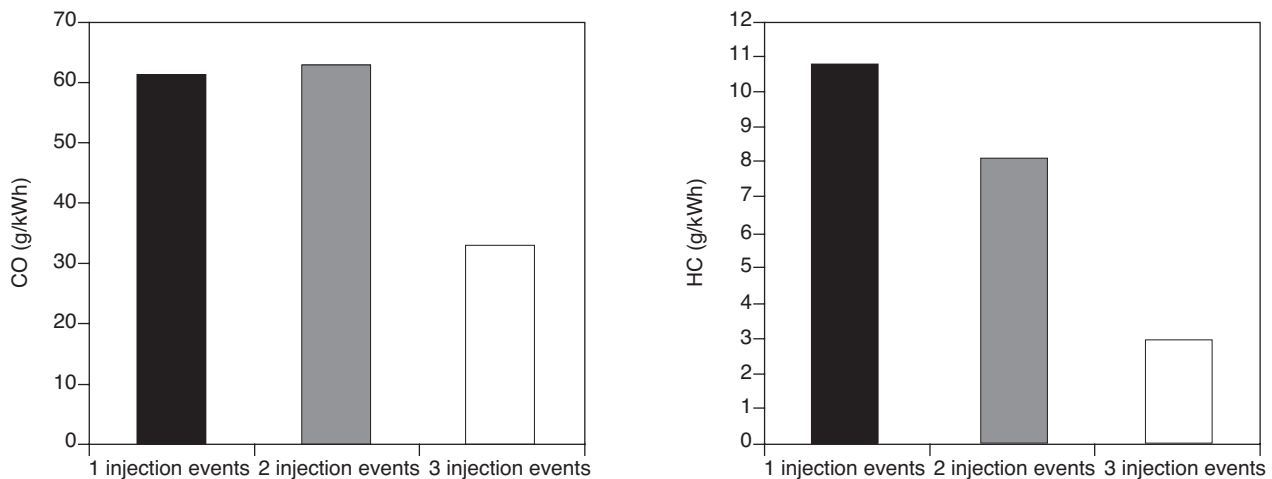

Figure 6
Multi staged injection effect on engine results, 1500 rpm – IMEP = 0.1 MPa.

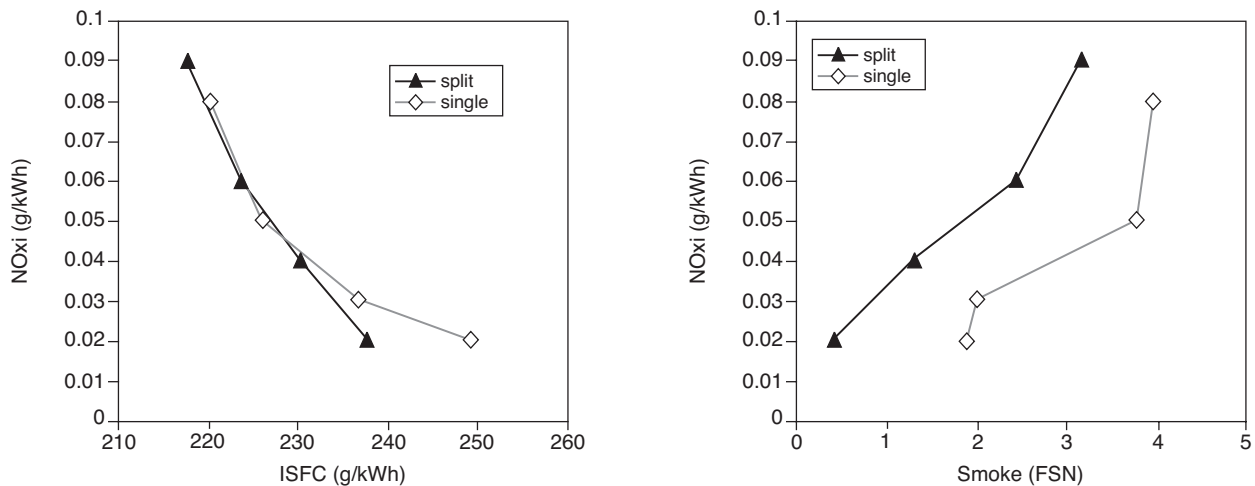

Figure 7
Injection strategy effect on NOx, smoke and ISFC, 1500 rpm – IMEP = 0.8 MPa.

achieved but with a strong increase of combustion noise and some fuel consumption penalty due to a pre-mixed combustion (“mass bulk combustion”) too fast and too early [7]. That is why, other injection strategies were investigated including late and split injections. The results show the clear advantage of using a fuel injection strategy named “TDC split injection”. This is a two injection strategy where the first injection is timed before TDC and the other one after TDC. The “TDC split injection” improves trade-off between particulate, noise and fuel consumption, by maintaining a better fuel consumption level than with the traditional late injection strategy. The following figures present the comparison between the two kinds of strategies at 1500 rpm, IMEP = 0.8 MPa. Figure 7 shows the NO_x/smoke/fuel efficiency trade-off. At a given level of NO_x, “TDC split

injection” produces less smoke and there is an additional advantage regarding fuel efficiency with an ultra low NO_x emissions target.

As shown in Figure 8, the split injection strategy maintains good combustion efficiency thanks to better combustion timing in the engine cycle.

Figure 9 shows the combustion noise measured with an AVL noise meter, HC and CO emissions. “TDC split injection” leads to less unburned fuel (HC and CO) what-ever the NO_x emissions target. “TDC split injection” combustion is less sensitive to EGR variation regarding combustion noise especially to reach very low NO_x emission targets.

However, such injection strategy, because of its sensitivity to injection timing, requires very close behaviour for all the

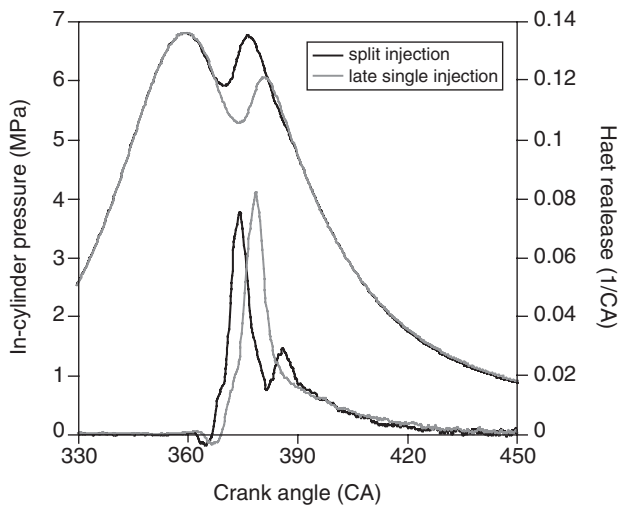

Figure 8
Injection strategy effect on in-cylinder combustion, 1500 rpm – IMEP = 0.8 MPa.

injectors. A comparison between two fuel injection systems (second and third generation from Bosch) done with the same combustion system highlights the impact of multiple injection events capability on the results at 1500 rpm. As shown in Figure 10, the main advantages of a piezoelectric injector system is a larger highly premixed combustion operating range which reaches 0.8 MPa of BMEP without any significant penalty in terms of fuel consumption, noise, NOx and particulate emissions. It should be noted that HC and CO emissions are drastically dropped due to a lower Air/Fuel equivalent ratio resulting from injection strategies used with the third generation injection system.

At full load, there is a clear advantage to improve the linear momentum of the spray in order to reach the bowl periphery and the squish area earlier. At the same time, it is obvious that the reduction of injection duration for a given injected quantity allows higher combustion speed and thus less smoke and exhaust temperature. That is why we compared at 4000 rpm, full load, two Bosch fuel injection systems differing from maximum injection pressure, needle lift speed and hole geometry. Table 1 summarises the difference.

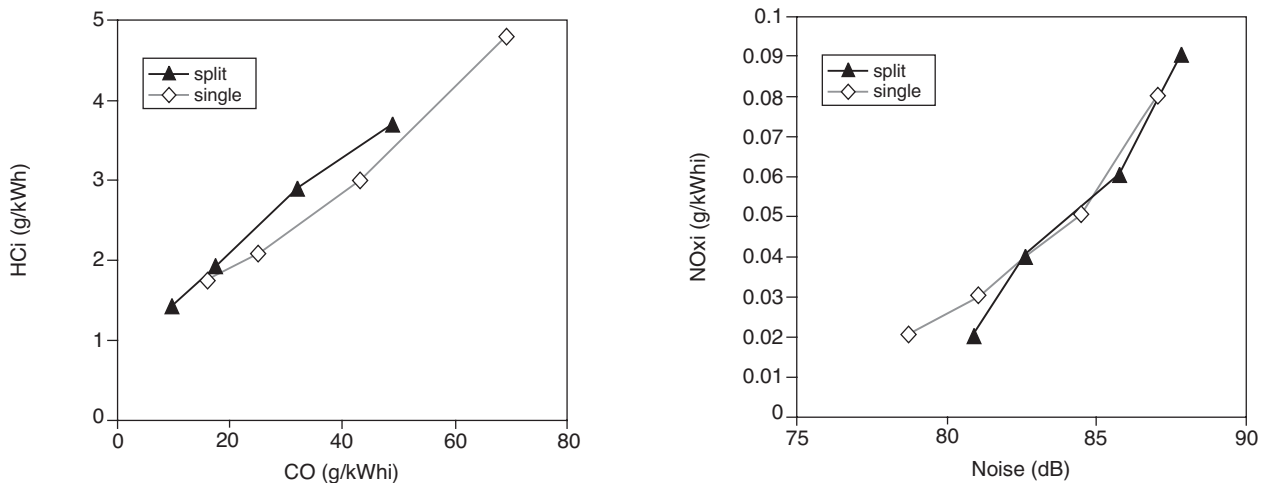

Figure 9
Injection strategy effect on HC, CO and Noise, 1500 rpm – IMEP = 0.8 MPa.

TABLE 1
Difference between second and third generation Bosch system features

	Second generation Bosch system	Third generation Bosch system
Maximum injection pressure	160 MPa	180 MPa
Nozzle flow	450 ml/30 seconds/10 MPa	425 ml/30 seconds/10 MPa
Nozzle type	VCO	Mini-sac
Nozzle hole geometry	6 holes, 60°, K = 0	6 holes, 60°, K = 1.5
Needle lift speed	About 1 m/s	Up to 2 m/s

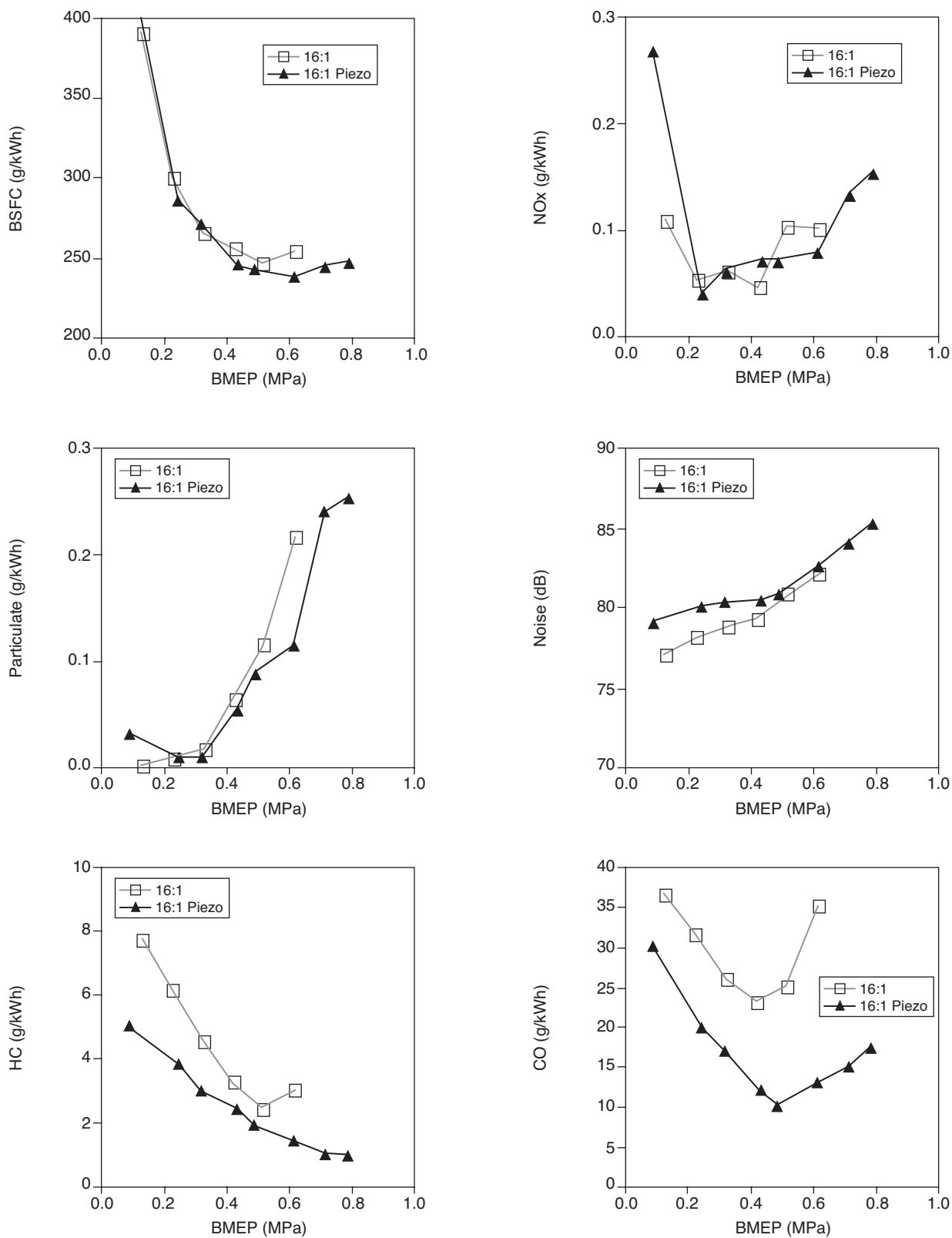

Figure 10
Injection system effect on engine results, 1500 rpm.

Figure 11 presents the results obtained with a single cylinder engine equipped with a NADI combustion system (unit displacement of 550 cm³, compression ratio of 16:1) at 4000 rpm, full load. These curves confirm that the improved injection system leads to a better performance level and the difference is greater as air mass flow increases. In addition, the third generation Bosch injection system improves output power by about 2% for the same injection pressure of 160 MPa.

Injection system definition for multi-cylinder engine testing: Given the results obtained on a single cylinder engine, we will select the third generation Bosch fuel injection system for its improved multiple injections capability, injection pressure and needle lift speed.

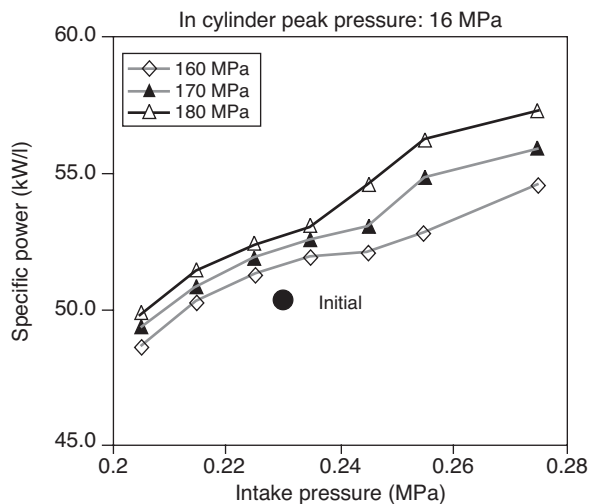

Figure 11

Injection pressure effect on output power at 4000 rpm, full load.

1.3 Air Loop Circuit

The air loop circuit has to be suitable for both running conditions at full load and at part load.

At full load, the output torque and power specifications impose the air mass flow required by the engine according to the geometric compression ratio.

At part load, the HPC mode needs high EGR mass flow, especially at very low engine load. There is no problem on these running points because the corresponding air mass flow required by the engine is low. But when engine load increases, the compressor must supply sufficient air flow to ensure engine load with lambda value above 1.1, while high burnt gases mass flow is needed for combustion control.

There are different ways to increase required compressor work. A two stage turbo-charger can be used to obtain a higher compression ratio, which allows more air to be

introduced in the engine for a given burnt gases mass flow. A variable geometry compressor is also an interesting way to develop by tuning continuously the compressor map to the engine running point. E-boosts and turbocharger electrical assistance are other solutions to compensate the lack of exhaust energy when gas temperature is low.

However the present paper only described a conventional single stage turbocharger application.

Two means to fulfil the air loop specifications are now described. They are “Conventional air loop circuit” or “High Pressure EGR” and “Modified air loop circuit” or “Low Pressure EGR”. Due to the high burnt gases mass flows required by engines running in the HPC mode, the EGR circuit has to be designed in both cases to allow a high EGR rate while maintaining low pressure losses which increase fuel consumption.

1.3.1 High Pressure EGR

In this EGR circuit layout, burnt gases are picked up upstream of the turbine and mixed to fresh air downstream of the compressor. So only fresh air passes through the compressor. When engine load increases in the HPC mode, EGR and fresh air mass flow increase requires high intake pressure which can make the compressor operate near the surge line at low engine speed. Small compressor size has then to be preferred. But future target standards for the maximum output power impose an adapted air mass flow leading to larger compressor size. So the compressor has to be compatible with high and low engine speeds. Compressor choice is quite helped by turbocharger development progress which leads to enlarged compressor maps.

On the other hand, the weak exhaust gas energy available for the turbine at low engine speed, which is further reduced by a high EGR rate, makes turbine efficiency a very important parameter to consider for choosing a turbocharger.

Because the EGR rate used in highly premixed combustion is significantly higher than in conventional combustion, advanced development of a specific cooler and valve are required both for the permeability aspect and for the fouling resistance. EGR cooler effectiveness is also an important parameter to be considered because of the high hot burnt gas mass flow used.

Another EGR circuit feature to be ensured is variable temperature of burnt gases because it leads to better pollutant emission levels. By-passing the EGR cooler is in fact a simple way to vary the burnt gases temperature, already used on the production engine.

Finally, the EGR rate target has to be reached as closely as possible when the engine runs in transient operations in order to avoid any combustion noise or uncontrolled smoke peaks. So the short circuit allowed by High Pressure EGR layout is favourable to reduced EGR circuit response time.

1.3.2 Low Pressure EGR

In this EGR circuit layout, burnt gases are picked up downstream of the turbine, after the particulate filter and mixed with fresh air upstream of the compressor. Fresh air and burnt gases thus pass through the compressor and the turbine. That leads to a better use of the turbocharger. Indeed, compressor working points go away from the compressor surge line by increasing gas mass flow and they are situated in an improved compressor efficiency zone. It is the same for the turbine which is crossed by the whole gas mass flow. The turbine then operates in a better efficiency zone.

But very low pressure difference between the downstream particulate filter and the upstream compressor requires the inlet or exhaust line to be partially closed in order to increase the burnt gas mass flow. At this stage in development, the exhaust solution seems to be the best one as it leads to a larger fuel saving.

Because burnt gases are picked up downstream of the particulate filter, this filter has to filter the whole gas flow. Its fouling is then faster than in conventional EGR circuit. This must be taken into account for the particulate filter specification.

Concerning burnt gas cooling, there are greater possibilities than in High Pressure EGR layout because burnt gases, which are picked up downstream of the particulate filter, are cleaned. On the other hand, the burnt gases to be cooled have lower temperature because there is quite a long distance between the engine exhaust manifold and the particulate filter. But condensation of exhaust gases can generate more or less corrosive water drops depending on the fuel sulphur content.

This EGR configuration also requires an advanced EGR cooler particularly in terms of permeability in order to save fuel consumption by reducing pumping losses.

Because combustion is controlled by in-cylinder burnt gases in the HPC mode, EGR rate has to be as close as possible in each cylinder. As burnt gases are mixed with fresh air upstream of the compressor in Low Pressure EGR layout, the relative long distance between the compressor and the inlet manifold helps a lot to obtain an optimal homogeneous mixture in the engine inlet manifold. But this quite long distance leads to higher EGR circuit response time which can make Low Pressure EGR layout harder to manage in transient operations.

Finally, EGR circuit durability in terms of EGR cooler and valve fouling is clearly helped by cleaned burnt gases picked up downstream of the particulate filter.

1.3.3 Air Loop Definition for Multi-Cylinder Engine Testing

As described previously, each air loop system has advantages and drawbacks. However, the High Pressure EGR circuit was chosen, at this stage in development, for our multi-cylinder engine demonstrator because of its simplicity.

2 PRELIMINARY TEST-BENCH RESULTS ON A MULTI-CYLINDER ENGINE

Tests carried out on a single cylinder engine allowed us to define main choices for the multi-cylinder application. These choices concern combustion chamber parts and the geometric compression ratio.

This part of the paper presents the preliminary results obtained at full load and at part load on the multi-cylinder engine, in steady state operations. Engine management in transient operations has not been considered at this step in development.

2.1 Engine Configuration

This paragraph aims to describe the engine hardware used in terms of combustion chamber parts, compression ratio, turbocharger and type of EGR circuit.

The multi-cylinder application is based on a production engine. The main engine features are listed in Table 2.

TABLE 2
Main engine features

Bore x Stroke	87.0 x 92.0 mm
Number of cylinders	4
Displacement	2.188 l
Turbocharger	Garrett VNT turbine geometry
Valve timing	Original manufactured engine valve timing

As mentioned previously, the components of the combustion chamber were defined using single cylinder tests.

The piston bowl was designed with the NADI™ bowl drawing specifications and the bowl volume was adapted to obtain a compression ratio of 14:1. The intake ducts of the cylinder head were modified in order to adapt the swirl motion to the required swirl number of 1.3 at BDC. All the results shown in this paper, including full load conditions were obtained with the same swirl number, without any inlet duct closure.

A second generation Bosch injection system was used for all the engine part load campaign, while a third generation Bosch injection system could be used at full load.

The main features of these two injection systems are as follows.

Second generation Bosch injection system (CR11):

- Solenoid technology with maximum injection pressure of 160 MPa
- Spray cone angle: 60°
- Number of holes: 6
- Flow rate: 500 ml/30 seconds/10 MPa.

Third generation Bosch injection system (CRIII):

- Piezoelectric technology with maximum injection pressure of 180 MPa
- Spray cone angle: 60°
- Number of holes: 7
- Flow rate: 425 ml/30 seconds/10 MPa.

The NADI™ application presented here is an engine equipped with only one turbo-charger. The turbocharger technology is conventional but the compressor and the turbine efficiency have been slightly improved compared to a production turbo-charger. However, a turbocharger somewhat larger was chosen at full load in order to reach the power target fixed at about 60 kW/l. The air circuit includes an air cooler to maintain the temperature at 50°C in the intake manifold at full load.

A High Pressure EGR circuit was chosen for this application because of its short response time in transient operation for further engine management development. This type of EGR circuit takes burnt gases in the exhaust manifold upstream of the turbine. The introduction of the exhaust gases is made downstream of the compressor, just upstream of the intake manifold, by means of a venturi to improve burnt gases with fresh air mixing. The EGR circuit includes a cooler which is supplied by a special low temperature water circuit. The EGR cooler can be by-passed, which allows an increase of the intake temperature favourable to HC and CO emissions at very low engine loads. A well-adapted valve allows the EGR rate to be controlled. The high EGR mass flows required by the NADI™ concept, particularly at low engine load, necessitated careful designing of the EGR circuit in order to maintain low level of pressure losses.

A specific engine management system has been developed by *IFP*. It allows the control of the different engine parameters in terms of injection timing and duration, injection pressure level, EGR rate using the EGR valve and the intake throttle and the inlet pressure using the variable geometry turbine.

After-treatment of exhaust gases has not been considered in this paper. Engine pollutant emissions presented hereafter are therefore raw emission levels.

A standard commercial Diesel fuel with less than 50 ppm sulphur content was used.

2.2 Full Load Tests

The engine runs in conventional combustion at full load with the NADI™ piston bowl.

Full load test results presented hereafter are related to the two main points of the full load curve. They are the maximum output torque running point at 2000 rpm and the maximum output power obtained at 4000 rpm.

The full load test conditions are as follows:

- Maximum in-cylinder pressure: 16 MPa
- Exhaust temperature: 750°C
- Smoke: < 3 FSN
- Maximum intake pressure: 270 kPa
- Intake temperature: 50°C.

At 2000 rpm, the maximum output torque level reached by the engine is 380 Nm with FMEP considered at 0.08 MPa, which corresponds to 172 Nm/litre. Such performance is quite compatible with future standards. Table 3 describes the main results obtained at this point.

At 4000 rpm, the maximum output power of 129 kW was reached by the engine with an FMEP considered at 0.2 MPa. This power level corresponds to 58.6 kW/l, which needs further improvements to reach the 60 kW/l value more compatible with future engine standards. Table 4 describes the main results obtained at this point.

2.3 Part Load Tests

Two engine speeds of 1500 rpm and 2500 rpm were selected to perform the HPC mode engine evaluation. The results obtained in this combustion mode with the NADI™ concept geometry were compared to results with conventional combustion mode with standard geometry on a production engine using a compression ratio of 18:1, and parameter settings consistent with Euro IV emissions standards.

Two combustion modes were used for each engine speed: the HPC mode for very low NO_x emissions with a high EGR

TABLE 3
Full load engine results, 2000 rpm

Output torque (Nm)	380
Specific output torque (Nm/l)	172
BMEP (MPa)	2.17
Smoke (FSN)	2.0
Noise (dB)	83.5
Intake pressure (kPa)	260
FMEP (MPa)	0.08

TABLE 4
Full load engine results, 4000 rpm

Output power (kW)	129
Specific output power (kW/l)	58.6
BMEP (MPa)	1.76
Fuel/Air equivalence ratio	0.75
Smoke (FSN)	3.0
Intake pressure (kPa)	270
FMEP (MPa)	0.2

rate and the conventional combustion mode for higher engine loads beyond the normalised cycle with a lower EGR rate.

The following graphs (Figs 12 and 13) show fuel consumption and pollutant emissions versus engine load for the two engine speeds considered at 1500 and 2500 rpm.

The 14:1 geometric compression ratio reduced value allowed us to achieve 0.6 MPa of BMEP at 1500 rpm and 2500 rpm, using the HPC mode. In this operating range, NO_x and particulate emissions are near zero and consistent with EURO V standard levels.

BSFC level were maintained at a good level at low engine load compared to the conventional combustion. For higher engine loads in the HPC mode, the BSFC increased slowly, which highlights the compromise between the BSFC level and NO_x emissions. Indeed, depending on engine parameter settings such as EGR or injection timings, it is possible to find different compromises between the four main results: BSFC, NO_x, smoke and noise. For example, results shows the highest engine working point in the HPC mode at 1500 rpm – BMEP = 0.6 MPa is adjusted in order to obtain

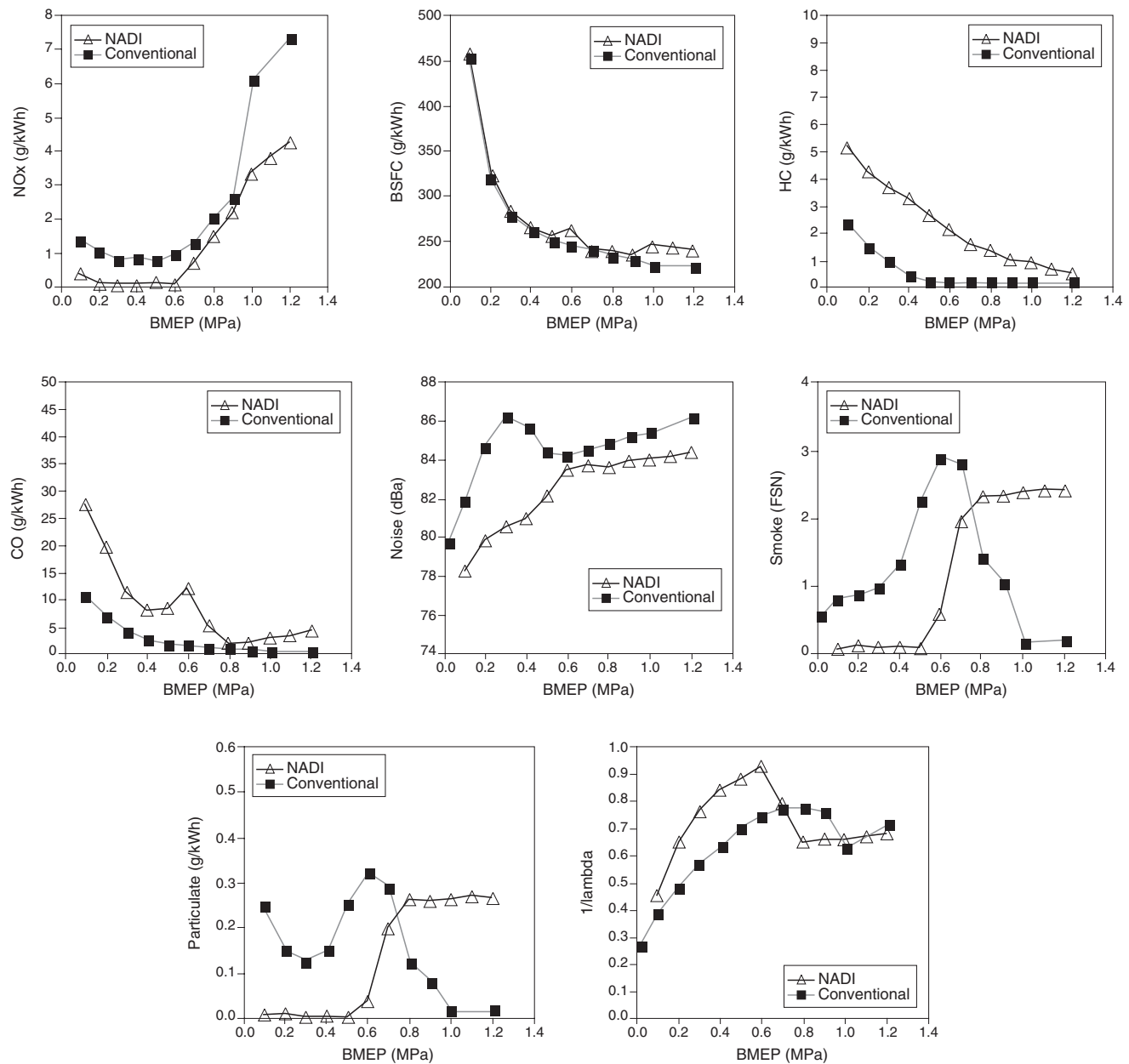

Figure 12

Multi-cylinder engine results, 1500 rpm.

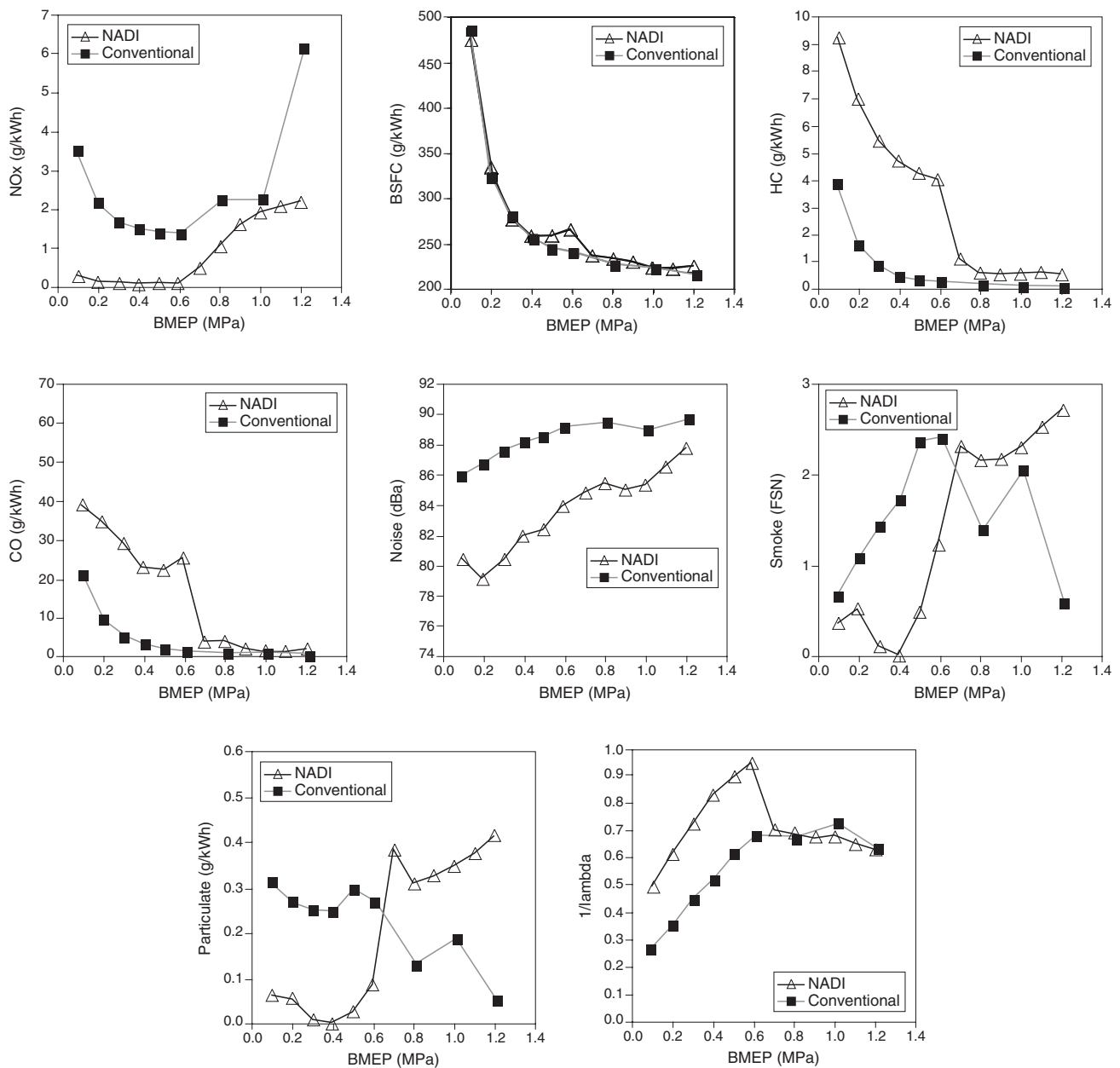

Figure 13
Multi-cylinder engine results, 2500 rpm.

very low NOx emissions. But the BSFC is then increased by about 7% compared to the conventional combustion whose NOx emissions are about nine times higher.

HC and CO emissions in the HPC mode also overtake conventional combustion levels, but they are well reduced at low engine loads thanks to hot EGR. The intake temperature increase helped fuel vaporisation which leads to better local air/fuel mixing. So unburned HC are reduced and combustion produces less CO. Multi-stage injections still improve HC and CO emission levels at low load by injecting very small

amounts of fuel without any large wall wetting. The HC and CO emissions are thus not too high with levels in the same range or lower than for a gasoline direct injection engine. However, as the exhaust temperature is low, especially at low engine speed and load, improvements of oxidation catalyst performances will be required. However, when engine speed increases, the exhaust temperature is high enough to oxidise the HC and CO more easily using a catalyst.

As for NOx emissions, smoke is maintained at very low levels up to 0.6 MPa of BMEP in the HPC mode for the two

engine speeds. Such results are obtained thanks to the delay existing between the end of injection events and the start of combustion. TDC split injection strategy, as described in the first part of the paper, allows this delay to be increased without too high a fuel consumption penalty compared to the late injection strategy.

The noise levels are also significantly lower than conventional combustion levels. That is partly due to the EGR effect but, above all, to the injection strategy effect which slows down the combustion heat release rate.

As previously said, the operating range in highly premixed combustion is limited to 0.6 MPa of BMEP at 1500 rpm and 2500 rpm. That could come from EGR mass flow limitation. But it is not the case here because of good EGR circuit permeability. Indeed, even at medium load, the EGR rate has to be regulated with an EGR valve which is never totally opened.

In fact, the operating range limitation could also come from turbocharger limits. Indeed, the more the engine load increases the more the air and EGR mass flows have to be increased. This gas mass flow increase requires higher and higher intake pressure levels. But the increasing downstream compressor pressure level imposes turbine section reduction which leads to high engine pumping losses. In addition, compressor works in worse and worse efficiency zones. At the end, pumping losses reduce BMEP significantly which limits the operating range. Low engine speeds are more critical in terms of compressor working point because compressor efficiency depends on gas flow level. Moreover they do not provide much exhaust gas energy for the turbine. That is why the BSFC increases at the highest engine loads operated in the HPC mode, particularly when engine speed is low. Turbocharger efficiency improvement is thus a major way of extending the operating range of the highly premixed combustion.

Beyond 0.6 MPa of BMEP, highly premixed combustion cannot be operated and the engine runs in conventional combustion. However, it should be noted that comparison between results obtained at medium and high load with the NADI™ concept geometry and conventional geometry is quite difficult because of the very different NO_x emission levels targeted with each concept. Higher fuel consumption and smoke emission levels relative to the NADI™ concept geometry are mainly due to the difference of compromise between NO_x emissions and BSFC achieved with each concept. For example, the engine running point at 1500 rpm, 1.0 MPa of BMEP can be achieved with NO_x emission level at 6 g/kWh without any fuel consumption penalty compared to the reference. Moreover, noise levels targeted with the NADI™ concept geometry are lower than noise levels relative to conventional geometry. So, compromise between NO_x emissions and fuel consumption level has to be well adapted to the minimum required by normalised cycle standards in order to obtain the best fuel consumption levels.

3 ENGINE CONTROL DEVELOPMENT

Engine management is nowadays a key point in new production engines. Because highly premixed combustion is more sensitive to tuning than conventional Diesel combustion and due to the fact that transition between several combustion modes must be managed during transient operations, the control of NADI™ concept engine requires specific development.

3.1 Development Process

IFP uses advanced development process to manage the challenge of NADI™ engine control development. This

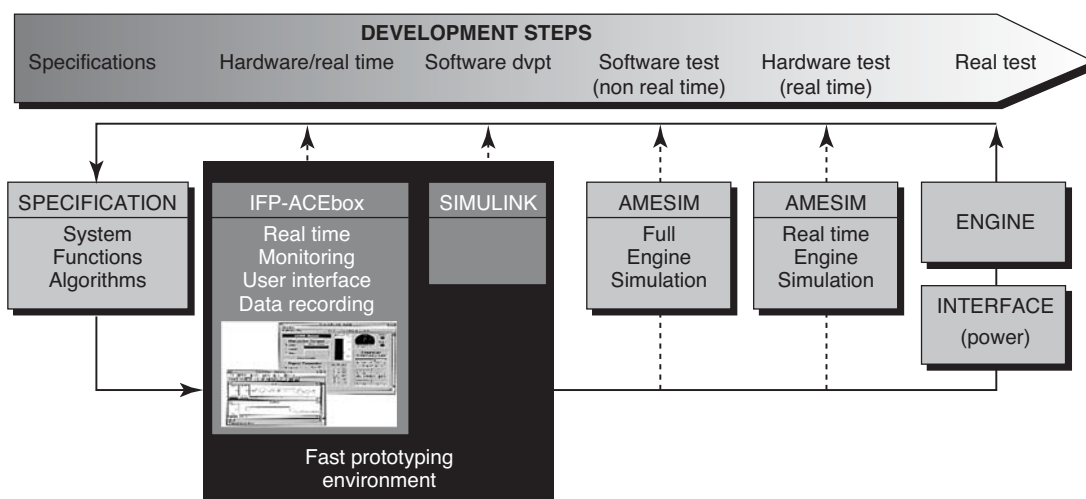

Figure 14

Engine control development process.

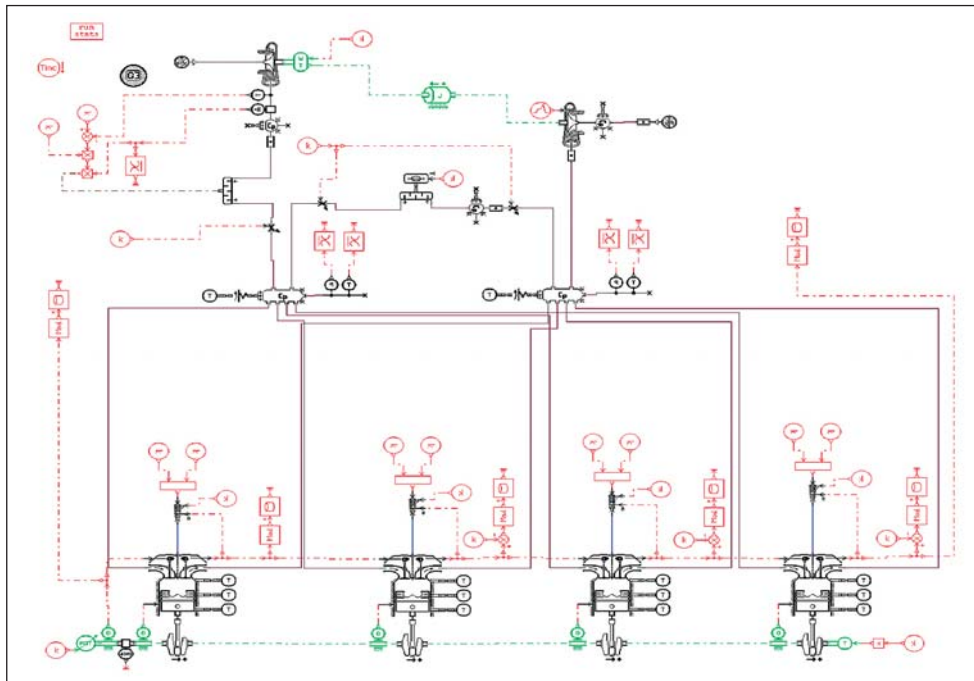

Figure 15

Sketch of engine model with AMESim.

development process is based on the simultaneous use of simulation and fast prototyping environment, as summarised on Figure 14.

The engine simulation is performed on the AMESim platform with a large use IFP-ENGINE™ library. A detailed model is first built and validated with stationary and transient test results (Fig. 15). This validated model is then used as a phenomenological understanding support in order to identify the system relevant dynamics for control and to access to internal variables into the cylinder. An AMESim™/Simulink™ co-simulation platform is achieved to compute simultaneously the engine model and the controller system. Finally, the engine model is embedded in the achieved controller system to be compiled for real-time xPC target in order to perform controller hardware-in-the-loop validation before installation on the engine bench.

Software developed on Simulink™ with simulation tool is then transferred on the fast prototyping platform uses at test bench, ACEbox which used the same xPC target system.

3.2 Control Structure

Torque structure is used to control the engine from the driver requirement. Torque manager filters this demand and converts into IMEP set point. This set point enters cylinder management which controls the combustion and fixes air and fuel parameters set points. Air path and Fuel path converts finally air and fuel parameters set points into actuators control.

3.3 Development of Strategies for NADI™ Engine Control

Because of the high sensitivity of NADI engine to tunings, injection system and air loop circuit have to be precisely managed.

Air Loop Control

Indeed, Low Temperature Combustion (LTC) depends closely on thermodynamic behaviour inside the combustion chamber. Then fast and precise EGR control is so required. In addition, EGR circuit response time is long, particularly in the case of the Low Pressure EGR layout what complicates the follow-up of the targeted EGR rate. Several actuators are used (intake throttle, waste gate or VGT, EGR valves) to control the air loop. A multivariable control has been set up to manage this actuators. Figure 16 shows the multivariable control operated on inlet throttle and EGR valve during an (engine speed, IMEP) variation to follow an EGR trajectory and the corresponding response (AMESim™/Simulink™ co-simulation results).

Fuel Control

Precise injection models with multi-injection capacities are required. Special attention must be paid to insure the injections phasing and quantity during LTC combustion and modes changes.

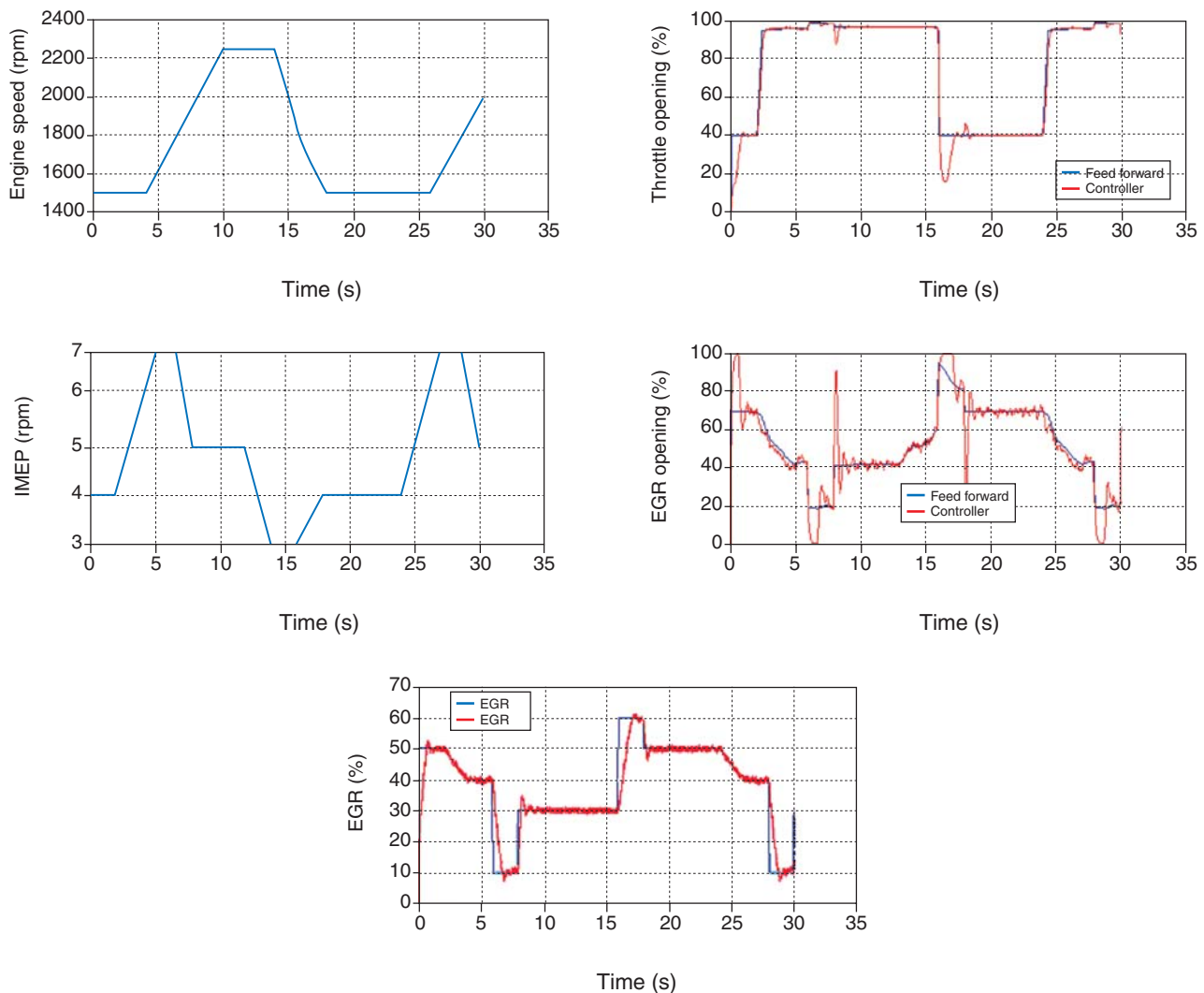

Figure 16

EGR control during (engine speed, IMEP) trajectory.

Combustion Control

Disparities between cylinders can reduce dramatically NADI™ combustion potential. IFP develops then advanced cylinder to cylinder control based on Air/Fuel ratio and torque observers. The Air/Fuel ratio observer gives Air/Fuel ratio disparities between cylinder with the help of the measurement of a unique lambda exhaust sensor which could be placed after turbine. The torque observer translates the measurement of crankshaft speed into individual energy release of each combustion. Controllers are used to minimise the observed disparities between cylinders.

CONCLUSION AND PERSPECTIVE

This paper has listed various technologies required for the development of this concept. Most of them, such as new

generations of turbocharger, fuel injection systems, air loop circuit design and after treatment technology, will be in production in the very near future.

Regarding the engine results obtained on the test-bench, the NADI™ concept proposed by IFP seems to be a promising solution to meet future pollutant emission standards. The application of this concept on a multi-cylinder engine showed the zero NO_x zone is up to 0.6 MPa of BMEP on the two engine speeds considered. However, these results show the limitation of the High Pressure EGR configuration in terms of engine load operating range. Engine noise when operating in the HPC mode remains compatible with car manufacturer standards, all over the near zero NO_x emissions zone. On the other hand, HC and CO emissions still have to be reduced at very low engine load and speed, when exhaust gas temperature is not high enough to maintain good oxidising catalyst efficiency. Performances at full load,

obtained with a third generation Bosch system whose maximum injection pressure is 180 MPa, reached 58.6 kW/l at 4000 rpm and 170 Nm/l at 2000 rpm.

Besides, engine management is nowadays a key point in new production engines, especially to answer the combustion noise challenge in transient and cold start operations. The NADI™ concept confirms that injection system and air loop circuit have to be precisely managed because highly premixed combustion is more sensitive to tuning than conventional Diesel combustion. Indeed, combustion in the HPC mode depends closely on the exhaust recirculated gas entering the combustion chamber. Fast and precise multivariable control of EGR has been set up. Closed loop combustion control could be necessary in order to limit combustion noise excursions as well as smoke and NOx emissions. Cylinder balancing must also be performed with the help of advanced observers.

Full-load performances and robustness seem at this step in NADI™ concept development to be the two main work axes which must be reinforced.

Indeed, full-load performances have still to be improved mainly in terms of output torque density. So, they will be consistent with future standards.

It appears also necessary to make the NADI™ engines behaviour more robust, to take into account the actuators and sensors dispersions in production and their drift against time. Closed loop control based on combustion sensor appears as a possible solution as well as the information crossing between sensors and observers.

ACKNOWLEDGEMENTS

We would like to acknowledge the *European Commission*, and the *Garrett* company for the support it has provided by supplying turbochargers.

REFERENCES

- 1 Cowland, C., Gutmann, P. and Herzog, P.L. (2004) Passenger Vehicle Diesel Engines for the U.S. SAE paper 20004-01-1452.
- 2 Gatellier, B. and Walter, B. (2002) Development of the High Power NADI™ Concept Using Dual Mode Diesel Combustion to Achieve Zero NOx and Particulate Emissions. Thiesel 2002 Conference on thermo - and fluid Dynamic Processes in Diesel Engines.
- 3 Gatellier, B., Miche, M. and Walter, B. (2001) New Diesel Combustion Process to Achieve near Zero NOx and Particulates Emissions. IFP International Congress - A new generation of engine combustion processes for the future?
- 4 Kahrstedt, J., Behnk, K., Sommer, A. and Wormbs, T. (2003) Combustion Processes to Meet Future Emission Standards. MTZ 10/2003.
- 5 Ranini, A., Gatellier, B. and Potteau, S. (2004) New Developments of the NADI™ Concept to Improve Operating Range, exhaust emissions and noise.
- 6 Umwelt Bundes Amt. (2003) Future Diesel - Exhaust Gas Legislation for Passenger Cars, Light-Duty Commercial Vehicles, and Heavy Duty Vehicles - Updating of Limit Values for Diesel Vehicles. www.umweltdaten.de/uba-info-presse/hinter-grund/FutureDiesel_e.pdf
- 7 Walter, B., Gatellier, B., Miche, M. and Monteiro, L. (2004) Improvement of Exhaust and Noise Emissions of the NADI™ Concept Using Premixed Type Combustion with Multiple Stages Injection. SIA International Congress "Les Diesel aujourd'hui et demain", Lyon.
- 8 Walter, B. and Gatellier, B. (2002) Development of the High Power NADI™ Concept Using Dual Mode Diesel Combustion to Achieve Zero NOx and Particulate Emissions. SAE paper 2002-01-1744.
- 9 Weissbäck, M., Csato, J., Glensvig, M., Sams, T. and Herzog, P. (2003) An Approach for Future HSDI Diesel Engines. MTZ 9/2003.

Final manuscript received in November 2005

Copyright © 2006 Institut français du pétrole

Permission to make digital or hard copies of part or all of this work for personal or classroom use is granted without fee provided that copies are not made or distributed for profit or commercial advantage and that copies bear this notice and the full citation on the first page. Copyrights for components of this work owned by others than IFP must be honored. Abstracting with credit is permitted. To copy otherwise, to republish, to post on servers, or to redistribute to lists, requires prior specific permission and/or a fee: Request permission from Documentation, Institut français du pétrole, fax. +33 1 47 52 70 78, or revueogst@ifp.fr.