



HAL
open science

Encapsulation of Crude Oil Emulsions

Ch. Noïk, H. Malot, Ch. Dalmazzone, A. Mouret

► **To cite this version:**

Ch. Noïk, H. Malot, Ch. Dalmazzone, A. Mouret. Encapsulation of Crude Oil Emulsions. Oil & Gas Science and Technology - Revue d'IFP Energies nouvelles, 2004, 59 (5), pp.535-546. 10.2516/ogst:2004038 . hal-02017320

HAL Id: hal-02017320

<https://ifp.hal.science/hal-02017320>

Submitted on 13 Feb 2019

HAL is a multi-disciplinary open access archive for the deposit and dissemination of scientific research documents, whether they are published or not. The documents may come from teaching and research institutions in France or abroad, or from public or private research centers.

L'archive ouverte pluridisciplinaire **HAL**, est destinée au dépôt et à la diffusion de documents scientifiques de niveau recherche, publiés ou non, émanant des établissements d'enseignement et de recherche français ou étrangers, des laboratoires publics ou privés.

Encapsulation of Crude Oil Emulsions

Ch. Noïk¹, H. Malot¹, Ch. Dalmazzone¹ and A. Mouret¹

¹ Institut français du pétrole, 1 et 4, avenue de Bois-Préau, 92852 Rueil-Malmaison Cedex - France
e-mail: christine.noïk@ifp.fr - christine.dalmazzone@ifp.fr - aurelie.mouret@ifp.fr

Résumé — Encapsulation d'émulsions pétrolières — La formation d'émulsions est inévitable en production pétrolière. La caractérisation de ces émulsions de pétrole brut est un challenge important car elle permet d'identifier les problèmes susceptibles de se produire dans les procédés de séparation. La caractérisation en ligne par les techniques classiques (diffusion de lumière, ondes acoustiques) est difficile à cause de l'opacité de ce type d'émulsions, du grand volume de phase dispersée et de la présence de gaz. Par conséquent, l'un des meilleurs moyens de mesure de la taille des gouttes des émulsions sur site est de prélever une partie représentative de l'écoulement et de bloquer le système. Ce procédé permet d'éviter la coalescence des gouttelettes avant l'analyse au laboratoire. La prévention de la coalescence peut se faire grâce à l'encapsulation des gouttelettes par formation d'un film de polymère à l'interface eau/huile. L'émulsion ainsi stabilisée, la distribution en tailles de gouttes est déterminée par des techniques classiques comme la microscopie optique associée à l'analyse d'images. Cette technique a été appliquée au laboratoire et validée sur site pétrolier. Les additifs ainsi que leurs concentrations ont été optimisés en fonction de la nature de la phase organique (pétrole brut) à diverses fractions de phase dispersée (eau salée).

Abstract — Encapsulation of Crude Oil Emulsions — The formation of crude oil emulsions is unavoidable during crude oil production. The characterisation of such emulsions on-site is an important challenge in order to identify problems that can occur in separation processes. On-line characterisation by classical techniques (light diffusion, acoustic attenuation) is particularly difficult because of the opacity, high volume fraction of dispersed phase and presence of gas bubbles. Consequently, one of the best way to measure on-site droplets size in crude oil emulsions is to sample a representative part of the flow and to lock the system, in order to avoid any coalescence of the droplets before analysis in the laboratory. Prevention of coalescence can be easily performed by encapsulation of the droplets by formation of a polymer film at the oil/water interface. Within this interfacial stabilisation, the emulsion droplets size distribution can be determined in the laboratory by classical techniques such as optical microscopy and image analysis. This technique was applied on-site to characterise actual crude oil emulsions but also in the laboratory. The additives were selected according to the nature of the organic phase (crude oil). Concentrations were optimised in order to obtain a resistant film of polymer, even for very high volume fractions of dispersed phase.

INTRODUCTION

Encapsulation means that one component (gas, fluid or solid) is separated in a reversible or not way by a surrounding membrane within another component. The encapsulation technique is largely applied in pharmaceutical and food industries. It was also used in the oil industry for products in additives formulations for different applications as drilling fluid, additives for production [1].

As oil production is always associated with water production, formation of water in oil dispersions or emulsions occurs and generates process problems. The characterisation of such emulsions directly on field is an important challenge in order to optimise the oil/water phase separation process. On-line characterisation by classical techniques (light diffusion, acoustic attenuation) is particularly difficult because of the opacity, high volume of dispersed phase and presence of gas bubbles. Consequently, one of the best way to measure droplets size in crude oil emulsions on-site is to sample a representative part of the flow and to lock the system, in order to avoid any evolution, break-up, or mainly coalescence of the droplets before the analysis in the laboratory.

In the literature, a nonexhaustive list of methods is identified for droplets, microparticles and nanoparticles encapsulation. For instance, the precipitation-solvent evaporation method, the injection technique or the encapsulation by solid-phase extraction are some processes currently used for biomolecules and proteins encapsulation. Some details on these methods are available in references [2, 3].

It is also possible to form a polymer layer around droplets and particles by carrying out a chemical reaction directly at the surface of the core particles. This method is called interfacial polymerisation. In 1959, Morgan *et al.* [4] developed a method of forming Nylon by rapid polycondensation of diacyl chlorides and diamines at interface of two liquid phases. To form a thin film of polymer, the diacyl chlorides were dissolved in the organic phase and brought together with an aqueous solution of a diamine without stirring. Investigations on the mechanism of membrane formation [4, 5] showed that morphology and properties of the membrane were controlled by the chemical reaction and reactants concentration.

In this study, the interfacial polymerisation process was retained as encapsulation method for petroleum emulsions. Indeed, the main advantages of this method are that the chemical reaction is rapid and does not require a specific set-up as in already precited processes. Moreover, rheological studies [6, 7] showed that the high resistance of the polymer layer under shear stress allows to avoid premature release of encapsulated compounds.

The objective of this work is to present a methodology to lock by encapsulation the water droplets in a crude oil phase. Encapsulation additives were selected according to the nature

of organic phase. The choice of the additives concentration is discussed. As applications, results obtained under laboratory conditions and oil field conditions are presented.

1 ENCAPSULATION PRINCIPLE

For encapsulating water droplets dispersed in an oil continuous phase, the interfacial polymerisation technique was proposed and developed for petroleum emulsion system. The polymerisation reaction considered is well known as it results from an amine reactivity with a carboxylic function which forms a Nylon type polyamide. In a previous research [8], polymerisation additives were selected for their compatibility with the water and oil phases and their quick polymerisation reactivity. Triethylene tetramine (TETRA) as hydrophile reagent and terephthaloyl dichloride (TDC) as hydrophobe reagent were selected to produce the following chemical reaction:

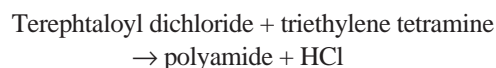

The chemical reaction is a polycondensation reaction with hydrochloric acid (HCl) as by-product. Due to the respective solubility of each monomer, the reaction takes place at the oil/water interface within two kinetic steps. The first step corresponds to the amine/carboxylic reaction that forms quickly a fine and compact top layer. This first mechanism is governed by the amine diffusion to the organic phase [9]. The reaction is then rapidly limited by the formed polymer molecular weight and the hydrochloric acid by-product.

In a second step, the thickness of the polymer layer increases. Due to amine partial solubility and carboxylic function insolubility in the aqueous phase, the membrane is preferentially formed in the oil phase. So, the layer increase is limited by the diffusion of the amine in the formed membrane [9].

The mechanical characteristic of the membrane, mainly its resistance to shear stress, is function of the thickness and density of the layer depending on the number of active functions in monomers, the concentration ratio between the 2 monomers and their solubility in the aqueous and organic phases [6, 10, 11].

2 MATERIALS AND METHODS

2.1 Materials

Experiments were performed with two types of oils: a crude oil A containing a low asphaltenes fraction and an asphaltenic crude oil B. For crude oil A, two samples corresponding to two different sampling dates are used and noted respectively crude FAB 1 and crude FAB 2. The composition of these crude oils and their associated brines are given in Table 1.

The brines correspond to the production water pumped simultaneously with the crude oil during the production.

$C_8H_4C_{12}O_2$ from *Merck* is dissolved in xylene solvent and used as such.

TABLE 1

Compositions of oil/water systems.
System A: crude oil containing little asphaltenes;
System B: asphaltenic crude oil

Crude oil composition	System A		System B
	Crude FAB 1	Crude FAB 2	Crude oil B
Saturated	57%	58.6%	19%
Aromatics	38%	34.1%	56%
Resins	6%	6.7%	12%
Asphaltenes	< 0.3%	0.7%	13%
Water salinity (mg/l)	Brine A		Brine B
	Brine FAB 1	Brine FAB 2	
HCO ₃	375	390	282
SO ₄	519	772	1096
Cl	3976	3600	1485
Na	2980	2139	1705
K	256	58.3	115
Ca	304	300	548
Mg	73	73	97

Small differences are observed in the composition of the samples FAB 1 and FAB 2 (crude oil and brine), but they remain negligible. Both samples are equivalent.

For encapsulation, the following additives were used. The triethylene tetramine (TETRA) $C_6H_{18}N_4$ was from *Prolabo* with a high grade quality. The terephthaloyl dichloride (TDC)

2.2 Mixing Procedures

2.2.1 Simple Mixing

Water and oil were mixed in a glass recipient using Polytron apparatus. The temperature is not controlled for experiments performed at ambient condition $T 20^\circ\text{C} \pm 2^\circ\text{C}$ or controlled in an oven for a temperature fixed at 80°C . Variations on the speed rate during phase mixing induce the formation of emulsion with various stability or droplet size distribution.

2.2.2 Dispersion Rig Set-Up

This system allows to form emulsions under more controlled hydrodynamic conditions than with the previous mixing procedure. Figure 1 shows a schematic view of the experimental set-up used to form the emulsions. The objective is to simulate the flow of crude oil and brine through the choke-valve by pumping both fluids through a calibrated orifice that represents a model choke-valve. The turbulent flow created downstream from the orifice leads to a dispersion of droplets in the continuous phase, *i.e.* emulsion formation. A programmable controller allowing a perfect synchronisation of both pumps pilots the simultaneous injection of both fluids. The ratio called water-cut represented the ratio between the water volume and the total water + crude oil volume injected. For each experiment, the water-cut is controlled and the total volume injected is fixed at 400 ml in our study. The third pump is a metering pump which injects additives on line just after emulsion formation. The fluid

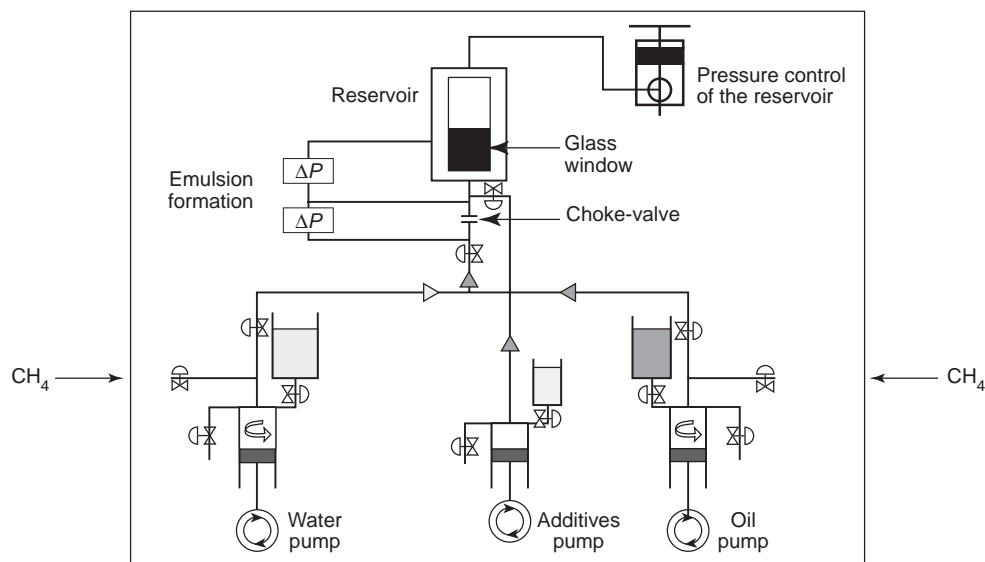

Figure 1
Experimental rig set-up.

TABLE 2
Influence of the monomers TETRA and TDC at $2.5 \cdot 10^{-2}$ mol/l
on the interfacial tensions (mN/m) of the oil/water system A (samples FAB 1 and FAB 2)

Organic phase	System A					
	Crude FAB 1	Crude FAB 1	Crude FAB 1 + TDC	Crude FAB 2	Crude FAB 2	Crude FAB 2 + TDC
Water phase	Brine FAB 1	Brine FAB 1 + TETRA	Brine FAB 1	Brine FAB 2	Brine FAB 2 + TETRA	Brine FAB 2
Interfacial tension (mN/m)						
Initial	25.3	22.1	25.3	24.2	21.1	22.4
After 1 h	23.5	18.1	15.8	19.1	15.2	16.4

pressure is measured at two locations, respectively 5.8 cm upstream and downstream from the orifice. This allows the measurement of the permanent pressure drop ΔP_{perm} induced by the orifice. The produced water/oil mixture is collected in a reservoir that is mounted 10 cm above the orifice. The entire equipment is placed inside a cupboard and can be heated up to a maximum temperature of 100°C. In our study the temperature was fixed at 25°C.

2.3 Analysis Techniques

2.3.1 Drop Size Technique

The drop size distributions of emulsions are determined by optical microscopy associated to an image analysis technique. The very thin layer of emulsion put on a microscope glass plate is observed with the Olympus CX 41 microscope. The best contrast between water droplets and oil could be obtained by using a lens with a magnification of 100, 200, 400 or 1000. The droplet images are recorded with the help of a digital camera Olympus Camedia. The image analysis is performed on a PC computer with the Analysis[®] software. The high droplets concentration in the emulsion generally makes necessary a manual selection of images. Each droplet is labelled by hand and the computer program calculates the mean drop diameter D_{10} , the standard deviation and the number of measured droplets. We remind that the diameter D_{10} corresponds to the arithmetic average of the number-based drop size distribution. The diameter of about 700 droplets is measured on each emulsion in order to be sure that the drop size distributions are statistically representative.

2.3.2 Microscopy

Scan electronic microscope (SEM) Jeol JSM 6300F and cryogenic technique are used for membrane image. Using an X-ray electron diffraction spectrometer (EDS), carbon and oxygen determinations are performed directly on electronic visualisation when it is technically possible, especially with sample with smooth topography to avoid preferential X-ray absorption.

2.3.3 Interfacial and Surface Tensions

Interfacial and surface tensions are measured at ambient temperature by means of the Wilhelmy-plate method using Krüss K12 apparatus.

3 RESULTS: ENCAPSULATION PROCEDURE

3.1 Monomer Behaviour

Tension measurements were performed with the two types of oil/water systems considering the effect of each monomer. Results are presented in Table 2 for both samples FAB 1 and FAB 2 corresponding to the system A and in Table 3 for system B. Monomer concentrations is fixed at $2.5 \cdot 10^{-2}$ mol/l and $5 \cdot 10^{-2}$ mol/l for all measurements with systems A and B, respectively.

TETRA monomer reacts as a surfactant and modifies the oil/water interface properties by decreasing the value of the interfacial tension. TDC monomer is preferentially soluble in oil phase. For both additives, the decrease of the tension values over time is an indication of the mobility of the two monomers in their respective phase.

It is noteworthy that small variations on the interfacial tension values are observed between the samples FAB 1 and FAB 2, probably due to a few differences noted in the fluid compositions of both samples (see Table 1).

TABLE 3
Influence of the monomers TETRA and TDC at $5 \cdot 10^{-2}$ mol/l
on the interfacial tension (mN/m) of the oil/water system B

Organic phase	System B		
	Crude B	Crude B	Crude B + TDC
Water phase	Brine B	Brine B + TETRA	Brine B
Interfacial tension (mN/m)			
Initial	23.7	24.0	22.6
After 1 h	18.7	17.3	12.9

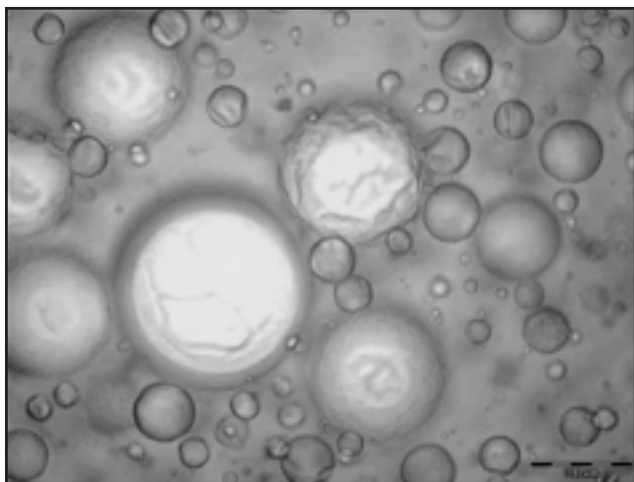

Figure 2
Encapsulated emulsion – System A – Preaddition.

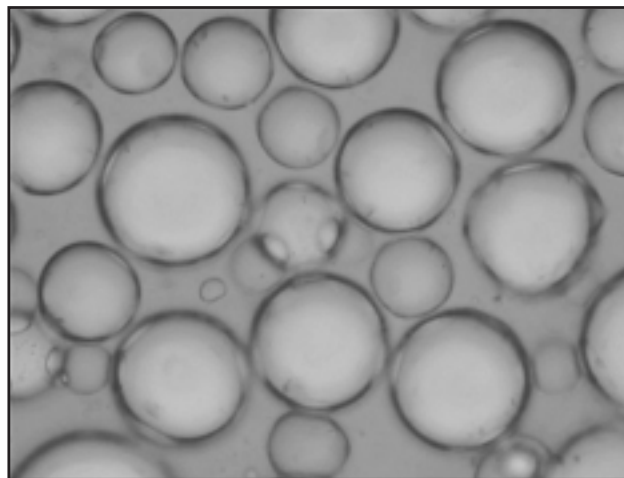

Figure 3
Encapsulated emulsion – System A – Postaddition.

3.2 Membrane Characterization

For this characterisation, two types of encapsulation procedures were studied. Considering that all the studied emulsions are water-in-oil, it is preferable for additive diffusion to first add the monomer soluble in the dispersed phase, that is TETRA reagent. First procedure was to dilute TETRA component in the water phase and then mix it with the oil phase to form the emulsion and finally inject the second monomer TDC. Or, in other way, after emulsion formation with the same mixing procedure, successive post-additions of the two monomers were performed. For both monomer additives, concentration was fixed at $5 \cdot 10^{-2}$ mol/l. These concentration and ratio were chosen within the objective to visualise the formed membrane.

In Figure 2 and Figure 3 are presented microscopy images of the emulsion encapsulated with system A at a dispersed water volume fraction of 50%, considering pre- and post-addition procedures, respectively. The two addition ways of reagents seemed not to have a great effect on the encapsulation kinetics as the two encapsulated emulsions had about the same droplet size distribution with a mean diameter of 15 μm . Apparently, time for monomer introduction and diffusion at the interface is less or in the same order as the droplet coalescence time of the nonencapsulated emulsion. Stability measurements performed just after mixing procedure, indicated that a clear water phase appears after 6 min of the initial emulsion formation.

The droplet size repartition in number and microscopic images indicated that the polymer membrane existed around small droplets (about 2-5 μm diameter), as well as around bigger ones with a magnitude diameter around 100 μm .

With the same system A with preaddition procedure and a dispersed water volume fraction of 50%, different

monomer concentrations were tested in order to visualise through SEM technique the polymer membrane thickness. When the monomers additives concentration was less than $1 \cdot 10^{-1}$ mol/l, it was delicate to observe the membrane (Fig. 4). When the concentration was increased up to 0.7 mol/l, polymer in excess deformed the capsules but a membrane with a thickness around 1 μm could be observed (Fig. 5).

During SEM observation (Fig. 6), using EDS technique (Fig. 7), it was possible to have a measurement of the variation of the carbon/oxygen ratio which clearly indicates the transition from the water phase to the oil phase through the polymer membrane. But, it is difficult to conclude on the evolution of the membrane growth, preferably in the oil phase.

3.3 Emulsion Formation with or without Encapsulation

In order to optimise the encapsulation procedure, other experiments were performed with the help of the dispersion rig set-up which allows to control more accurately the hydrodynamic conditions than with the classical mixing procedure. Emulsions were formed with the FAB 2 sample of the oil/water system A.

3.3.1 Additives Effect on Emulsion Formation

Effects of additives on the emulsions droplet sizes produced with the dispersion rig set-up were studied. The experiments were performed for a 30 l/h flow rate and a water-cut of 30 vol.% water. The influence of each additive such as TETRA, xylene and TDC dissolved in xylene were considered separately. The number-based drop size distribution

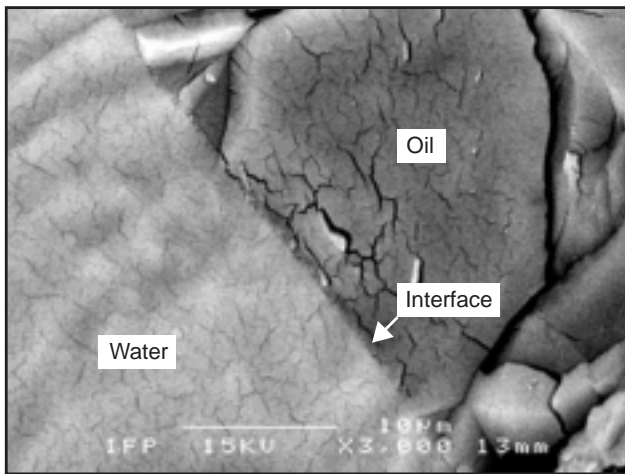

Figure 4
SEM observation – Encapsulated System A – Monomers
 $5 \cdot 10^{-2}$ mol/l.

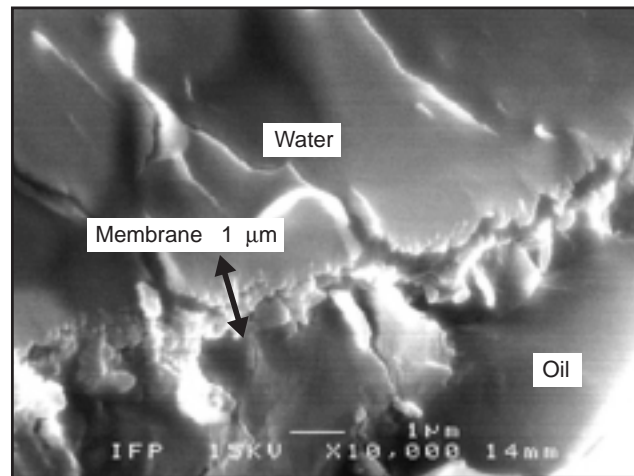

Figure 5
SEM observation – Encapsulated System A – Monomers
0.7 mol/l.

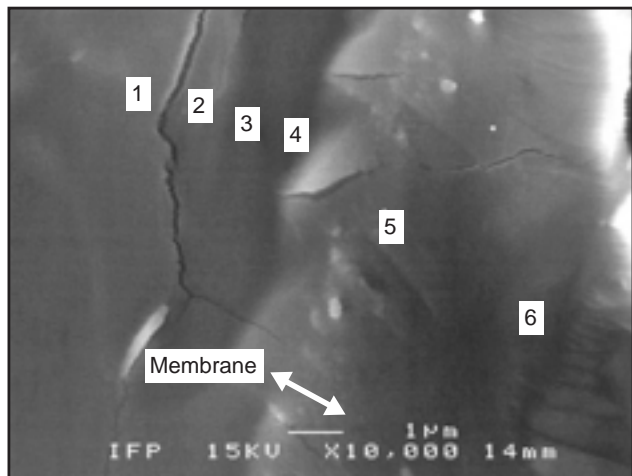

Figure 6
SEM observation – Encapsulated system A – Monomers
0.7 mol/l.

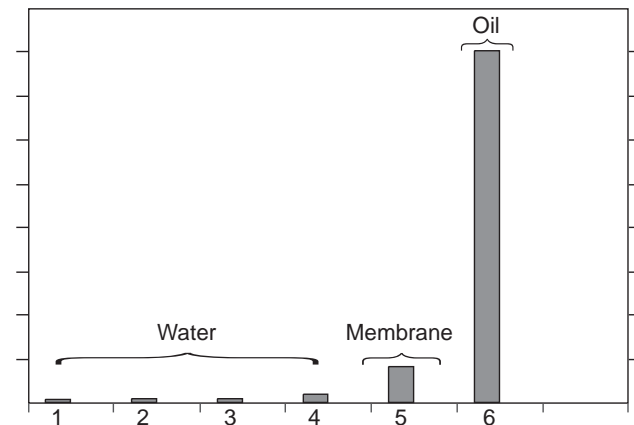

Figure 7
SEM/EDS observation – Encapsulated System A – Monomers
0.7 mol/l – C/O ratio evolution through the membrane.

(noted f_n) was determined by optical microscopy fifteen minutes after emulsion formation. The distributions satisfied the normalization condition such as:

$$\int_0^{+\infty} f_n(D) dD = 1$$

The additives concentration was fixed at $5 \cdot 10^{-3}$ mol/l. Results are presented on Figure 8 and compared with the number-based drop size distribution obtained for the same emulsion without additives. Distributions are bimodal. The presence of additives in the emulsion have a nonnegligible effect on the resulting drop size distributions: we observed

the appearance of small droplets in the order of $1 \mu\text{m}$ which do not exist for the nonencapsulated emulsion. One possible explanation of the small droplets presence has to be related to the surfactant behavior of the additives TETRA and TDC that decreases the interfacial tension value of the oil/water system and consequently makes easier the formation of smaller droplets. However, it is observed that whatever the additive used the second peak of the drop size distributions is identical to this obtained without additives (centered around $15 \mu\text{m}$). This result shows that the additives, *i.e.* monomer additives as well as solvent, particularly influence the drop size distribution ranging from 1 to $10 \mu\text{m}$.

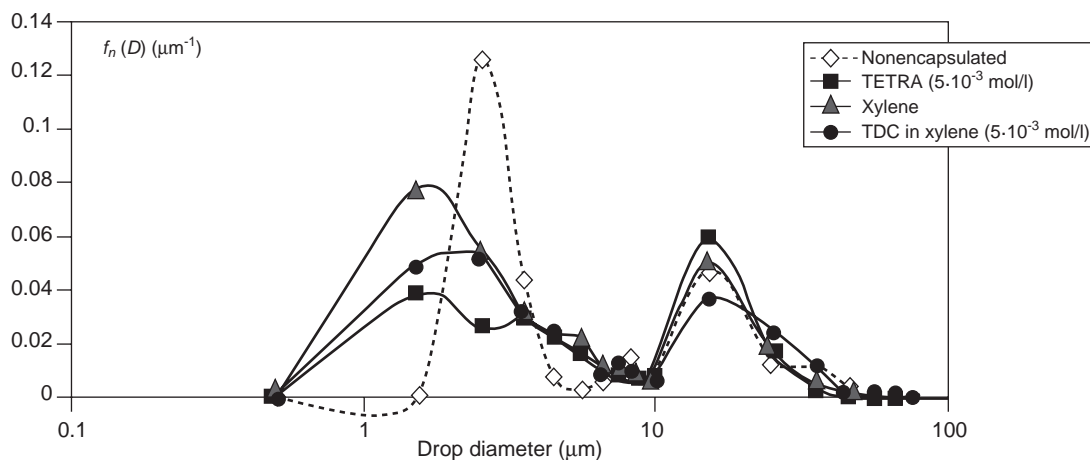

Figure 8

Additives effects on number-based drop size distributions.

3.3.2 Effect of Encapsulation on Emulsion Formation

The encapsulation procedure adapted to our experimental dispersion set-up was the following: TETRA was first added in the brine and the second monomer TDC, dissolved in xylene, was injected just after the emulsion formation thanks to the “metering pump”.

For the following experiments, the same conditions of formation emulsion conditions as previously described, were used: the flow rate was equal to 30 l/h and the water-cut to 30 vol.% water.

Figure 9 compares the number-based drop size distributions obtained for nonencapsulated and encapsulated emulsions. The monomer concentration is fixed at $5 \cdot 10^{-3}$ mol/l. For comparison, the number-baser drop size distribution of the nonencapsulated emulsion but containing a concentration of $5 \cdot 10^{-3}$ mol/l of TDC is reported.

It can be seen that the number-based drop size distribution of the encapsulated emulsion is close to this obtained with the addition of TDC dissolved in xylene: the first peak of these distributions is moved toward smaller drop diameters in comparison with the nonencapsulated drop size distribution. Thus, it is difficult to conclude whether the existence of small droplets in the order of $1 \mu\text{m}$ is only the consequence of the good locking of the water droplets by encapsulation or is also related to the additive effects on the oil/water interface. However, the second peaks of the nonencapsulated and encapsulated drop size distributions are identical. This result indicates that the droplets corresponding to this second peak are initial droplets not resulting from a coalescence phenomena.

3.3.3 Effect of Monomer Concentration

We are interested now in the effects of the monomer concentration on the encapsulated drop size distributions

versus time. The aim is to determine the optimal concentration of monomer for encapsulation in order to avoid any coalescence of the droplets before analysis in the laboratory. The number-based drop size distributions were measured at two times Dt after emulsion formation ($t=0$): $Dt_1 = 15$ min and $Dt_2 = 90$ min. The tested monomer concentrations were respectively equal to $5 \cdot 10^{-3}$, $7 \cdot 10^{-3}$ and $5 \cdot 10^{-2}$ mol/l. The emulsions were formed at a 30 l/h flow rate and a water-cut of 50 vol.%.

Figures 10a and 10b compare the encapsulated number-based drop size distributions measured for the different concentrations at two time values respectively Dt_1 and Dt_2 . We observe that for a same concentration the drop size distributions are similar between times Dt_1 and Dt_2 . As a first result, all the three tested concentrations allow to keep the polymer layer around the droplets during at least 90 min. As a complementary information, it is noteworthy that the corresponding nonencapsulated drop size distributions are also similar for both time values Dt_1 and Dt_2 , which indicates that the emulsion is very stable in our formation conditions.

On Figure 10a as on Figure 10b, the encapsulated drop size distributions formed with the concentrations $5 \cdot 10^{-3}$ and $7 \cdot 10^{-3}$ mol/l are equivalent. They spread on the range of diameters of 1 to $15 \mu\text{m}$. On the other hand, the whole encapsulated drop size distribution with the concentration $5 \cdot 10^{-2}$ mol/l is moved toward bigger drop diameters (10 – $65 \mu\text{m}$) in comparison with the drop size distributions encapsulated at lower monomer concentrations. This result shows that the value of $5 \cdot 10^{-2}$ mol/l is a too high monomer concentration which leads to a large polymer layer around the drop. Consequently, drop diameters are overestimated. The choice of the monomer concentration $5 \cdot 10^{-2}$ mol/l must be ruled out in order to avoid erroneous results. Finally, a concentration value of $5 \cdot 10^{-3}$ mol/l for both chemicals (TETRA and TDC) seems to be sufficient to maintain

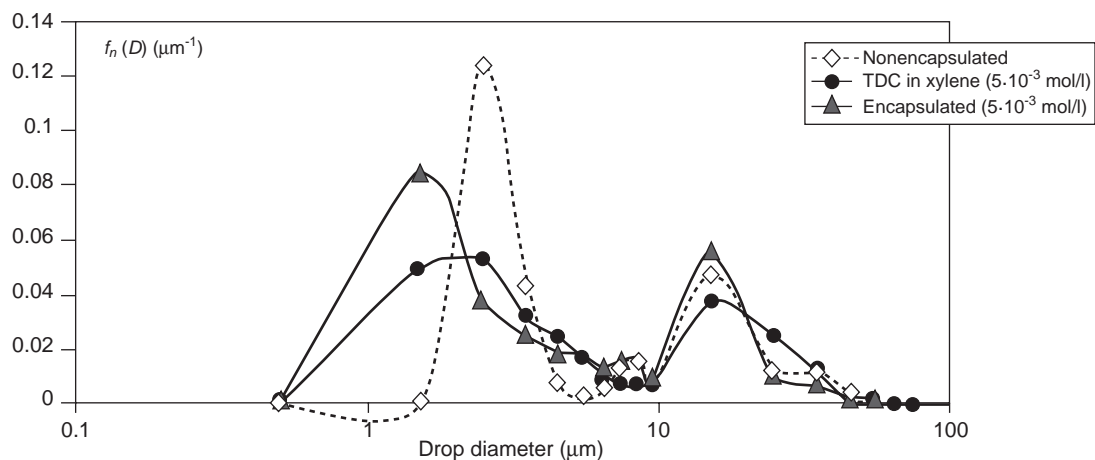

Figure 9

Comparison between nonencapsulated and encapsulated distributions.

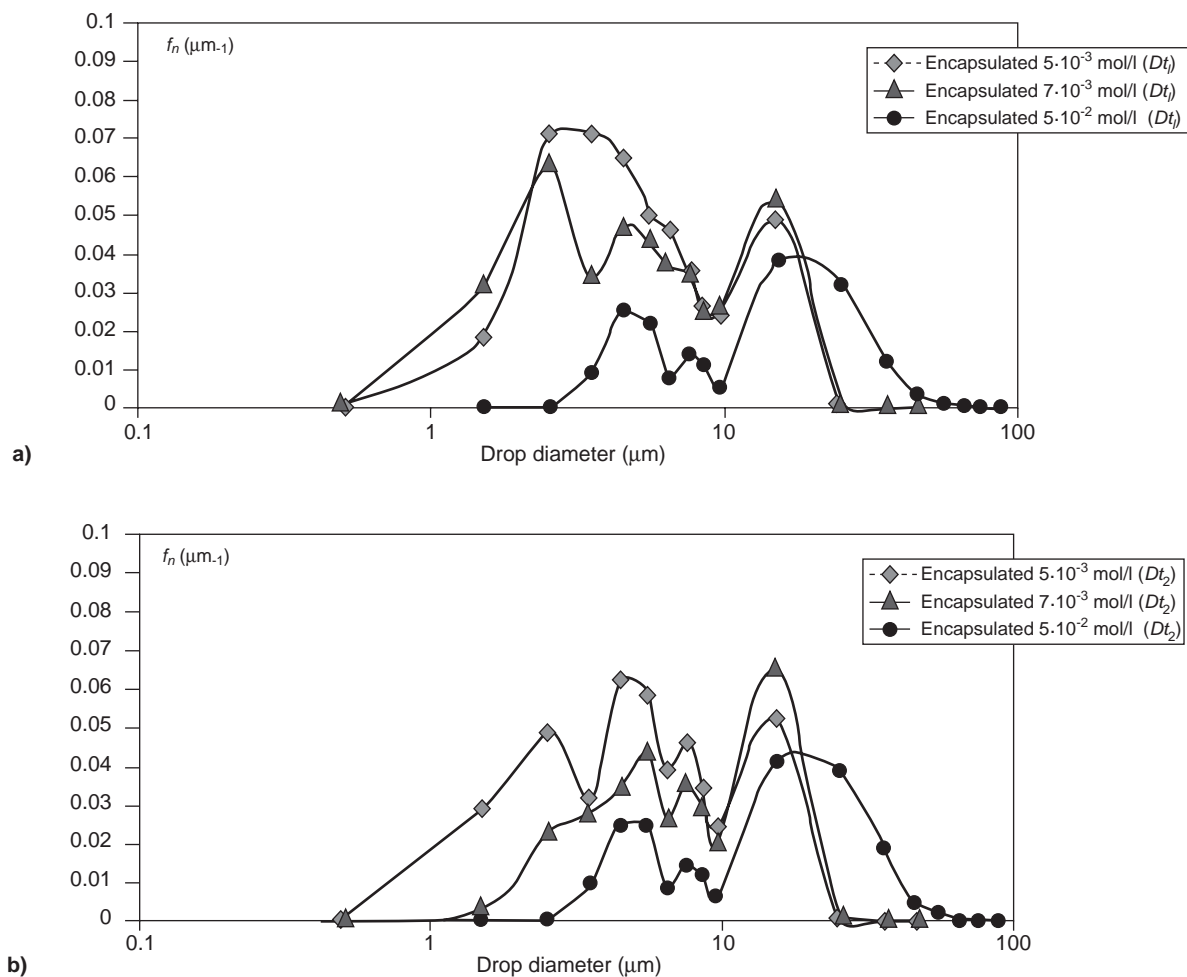

Figure 10

Influence of the monomer concentration on the number-based distributions *versus* time after emulsion formation: a) $Dt_1 = 15$ min; b) $Dt_2 = 90$ min.

encapsulated drops all along the analysis in the laboratory. In the following of the study, encapsulation will be achieved with this monomer concentration.

4 RESULTS: ENCAPSULATION EXPERIMENTS

4.1 Emulsion Formation with Encapsulation under Laboratory Conditions

The encapsulation procedure was applied to water-in-crude oil emulsion formed by the dispersion rig set-up with the aim of understanding the main parameters that control the formation of these emulsions. Emulsions were formed with FAB 2 sample of the oil/water system A. The influence of different parameters such as flow rate, water-cut and geometry of dispersion device was studied. For more details on this study, we refer to the reference [11].

4.1.1 Effect of Water-Cut and Flow Rate on Water-in-Oil Emulsion Formation

As an example, we present on Figure 11 the influence of water-cut on the number-based encapsulated drop size distribution of emulsions formed at a flow rate of 50 l/h. Emulsions were formed with a restriction of diameter $D_o = 0.6$ mm. Water-cuts were respectively equal to 30, 40, 50 and 60 vol.%. In such case, with our experimental conditions, the water and oil system was totally emulsified as water-in-oil emulsion. The results show that the drop size distributions are similar for the four water-cuts: they are bimodal and spread on the same range of diameters (1-25 μm). No problem was noticed to encapsulate drops at the additive concentration of $5 \cdot 10^{-3}$ mol/l for these water-cut values.

For a same water-cut of 50 vol.%, number-based encapsulated drop size distributions are presented on Figure 12 for

flow rates of 40, 50, 60, 80 and 100 l/h. The distributions are again bimodal. The main remark is that the flow rate increase induces an increase of the amounts of small droplets. It is correlated to an increase of the energy dissipation rate with flow rate which allows a better dispersion of the droplets in the oil phase. In the reference [11], a precise analysis of this phenomenon is given.

4.1.2 Encapsulation in the Case of Oil-in-Water Emulsions

The previous experiments show that the droplet encapsulation can be successfully realised with an additive concentration of $5 \cdot 10^{-3}$ mol/l for a large range of flow rates (30-100 l/h) and for a water-cut range of 30-60% for emulsions formed with the oil/water system A. It is noteworthy that this developed encapsulation technique is optimised for the study of water-in-crude oil emulsions. Consequently, when physico-chemical transformations occur in the water/crude oil mixture, especially in the range of water-cuts where oil-in-water emulsion tends to be formed (water-cut > 60% for system A), this encapsulation procedure can not be used to encapsulate correctly the whole system.

But in the case where a single oil-in-water emulsion exists, the following encapsulation procedure can be applied. As for water-in-oil emulsion, the monomer soluble in the dispersed phase is the first added in order to facilitate the additive diffusion. Consequently, the TDC dissolved in xylene was first diluted in crude oil and the second monomer TETRA was finally injected just after the oil-in-water emulsion formation.

Figure 13 compares an encapsulated and a nonencapsulated number-based drop size distribution corresponding to an oil-in-water emulsion made with FAB 2 sample of the oil/water system A. This emulsion was formed with the dispersion rig set-up for a water-cut value of 98 vol.% and a

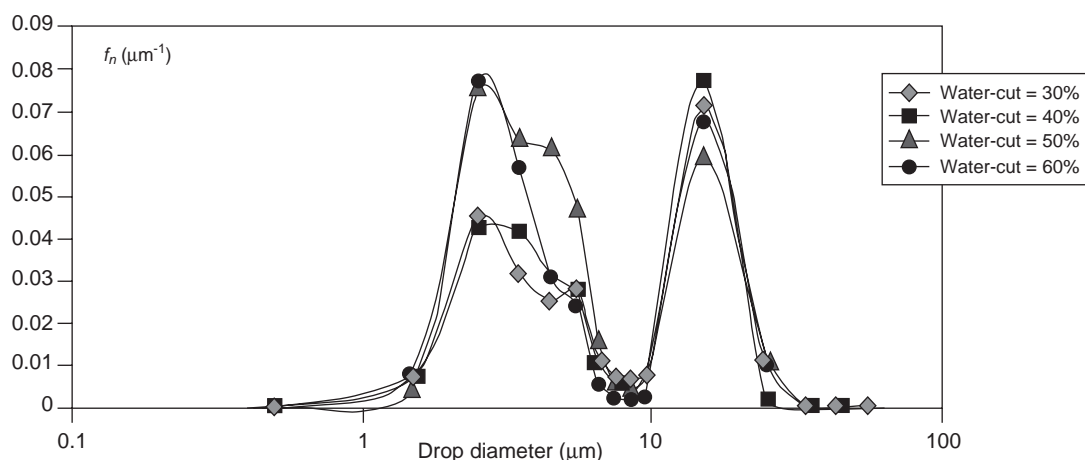

Figure 11

Influence of water-cut on encapsulated drop size distributions.

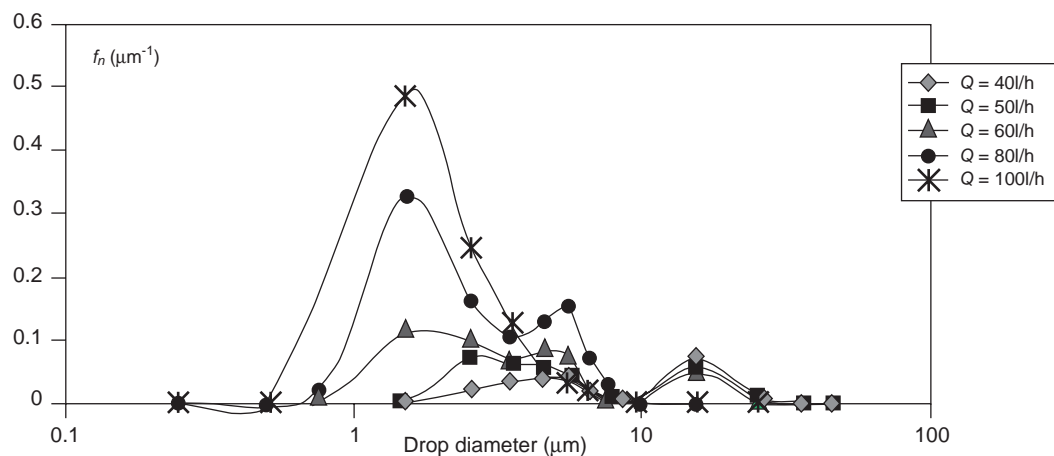

Figure 12

Influence of flow rate on encapsulated drop size distributions.

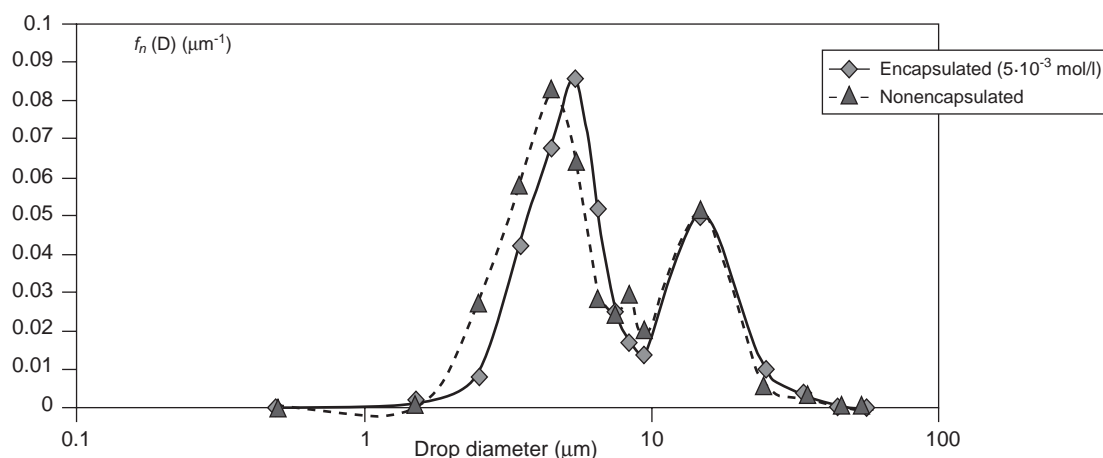

Figure 13

Encapsulation test on oil in water emulsion (water-cut 98%).

flow rate of 30 l/h. The concentration of both monomers was equal to $5 \cdot 10^{-3}$ mol/l. We observe that both distributions are bimodal and spread on the same range of diameters (1–35 μm). Only the first peak of the encapsulated distribution is very slightly moved toward greater diameter in comparison with the nonencapsulated distribution, but this effect can be considered as negligible. Nonencapsulated and encapsulated distributions of oil-in-water emulsions are similar.

4.2 Encapsulated Emulsion under Oil Field Conditions

To overcome the difficulty of emulsion analysis related to their instability and opacity, the encapsulation procedure was developed and applied on field. The aim of the field tests was to define a relation between a “mixing or dissipated energy” created during flow through choke-valve and the

stability and type of the formed emulsion. The “dissipated energy” is directly related to the pressure drop due to the choke valve. The same flow pattern as in the “dispersion rig” was implemented on a field test platform. Field facilities permitted to divert a part of the exported oil in order to mix it with produced water. Both flows were injected through a calibrated orifice and then collected in a test-separator unit.

Emulsions were encapsulated using the same procedure in laboratory and on the field. The crude oil corresponds to the system B previously defined (Table 1). Under field conditions, a sampling device was designed [12], in which a part of the overall flow was sampled and both chemical reagents, TETRA and TDC, were successively injected under pressure. Two sampling equipment were put at both sides of the orifice.

A good correlation between experiments through dispersion rig in laboratory and field test platform permits to define

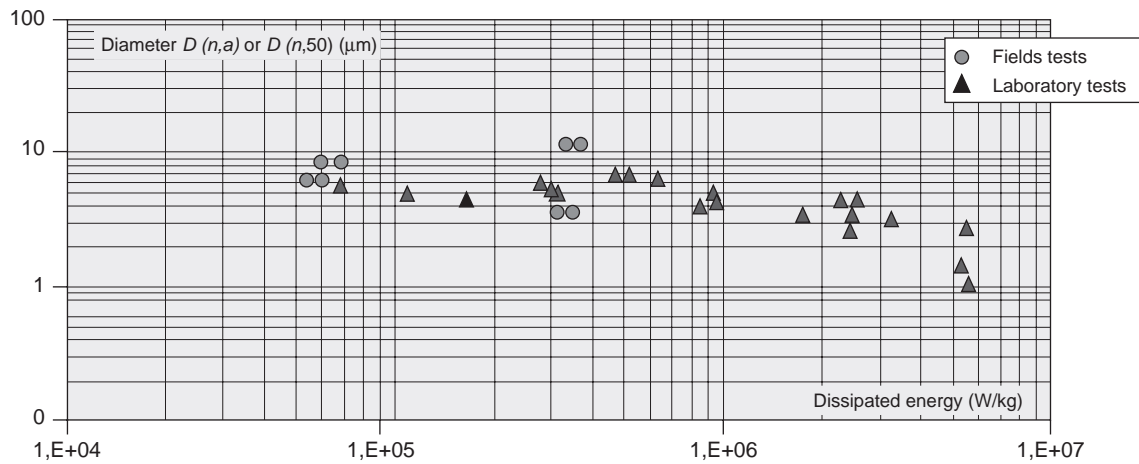

$D(n,a)$ = Number average diameter; $D(n,50)$ = Number diameter of 50% of droplet population.

Figure 14

Dissipated energy – Droplet size relationship – Field and laboratory tests for water-cut 30%.

a relationship between the “dissipated energy” and the average droplet size of the formed emulsion (Fig. 14). Detailed results of this study were previously presented [13].

During the preparation of these field tests, experiments were performed to optimise the encapsulation procedure and control the emulsion stability.

Effects of water cut and temperature were tested on system B with emulsion formed by mixing under agitation procedure followed by postaddition procedure for the additives TETRA and TDC. The oil/water system was totally emulsified (water-in-oil emulsion). Observations of the emulsion stability over a period of 24 h. were performed with and without encapsulation. Results are summarised in the following Table 4. As temperature increased, the emulsion

was less stable and droplet encapsulation permitted to stabilise the system for further analysis. Interfacial polymerisation occurred around droplet as large as 50 μm .

CONCLUSION

With the aim to analyse and characterise the drop size distribution of petroleum emulsion, a methodology was developed to lock by encapsulation the water droplets in a continuous oil phase. Encapsulation additives were selected and their concentration were optimised. The procedure permits to apply this technique both on water-in-oil and oil-in water emulsions. Applications under laboratory conditions

TABLE 4
Field test preparation: effect of temperature and water cut – System B

System B		Nonencapsulated emulsion	Encapsulated emulsion
Water-cut 30% $T 25^{\circ}\text{C}$	At $t = 0$	Emulsion $D(v,a) = 35 \mu\text{m}$	Emulsion $D(v,a) = 35 \mu\text{m}$
	At $t = 24 \text{ h}$	Total separation of water and oil phases	Stable emulsion $D(v,a) = 35 \mu\text{m}$
Water-cut 30% $T 80^{\circ}\text{C}$	At $t = 0$	Emulsion $D(v,a) = 50 \mu\text{m}$	Emulsion $D(v,a) = 50 \mu\text{m}$
	At $t = 24 \text{ h}$	3 phases: water, emulsion, oil	Stable emulsion $D(v,a) = 50 \mu\text{m}$
Water-cut 50% $T 25^{\circ}\text{C}$	At $t = 0$	Emulsion $D(v,a) = 30 \mu\text{m}$	Emulsion $D(v,a) = 25 \mu\text{m}$
	At $t = 24 \text{ h}$	3 phases: water, emulsion $D(v,a) = 25 \mu\text{m}$, oil	Stable emulsion $D(v,a) = 25 \mu\text{m}$
Water-cut 50% $T 80^{\circ}\text{C}$	At $t = 0$	Nonstable emulsion $D(v,a) = 50 \mu\text{m}$	Emulsion $D(v,a) = 45 \mu\text{m}$
	At $t = 24 \text{ h}$	3 phases: water, emulsion, oil	Stable emulsion $D(v,a) = 45 \mu\text{m}$

$D(v,a)$ = Volume average diameter

allows the study of the break-up droplet phenomena under controlled hydrodynamic conditions. Under oil production conditions on field, this technique permits to characterise the emulsion in order to prevent their formation.

ACKNOWLEDGEMENTS

The authors want to thank *TOTAL* for supporting this work and for the access to field facilities.

REFERENCES

- Collins, I.R, Jordan, M.M., Feasey, N. and Williams, G.D. (2001) The Development of Emulsion-Based Production Deployment Systems. *SPE 65026 Int. Symposium Oilfield Chemistry*, Houston, Texas.
- Hayes, D.G. (2000) Water-in-Oil Microemulsions: Protein Encapsulation and Release in Liquid Interfaces. In: *Chemical, Biological, and Pharmaceutical Applications (Surfactant Science Series 95)*, edited by Alexander G. Volkov, New York, Marcel Dekker, 469-485.
- Barichello, J.M., Morishita, M., Takayama, K. and Nagai, T. (1999) Encapsulation of Hydrophilic and Lipophilic Drugs in PLGA Nanoparticles by the Nanoprecipitation Method. *Drug Development and Industrial Pharmacy*, **25**, 4, 471-476.
- Morgan, P.W. and Kwolek, S.L. (1959) Interfacial Polycondensation. II: Fundamentals of Polymer Formation at Liquid Interfaces. *J. of Polymer Science*, XL, 299-327.
- Enkelmann, V. and Wegner, G. (1975) Mechanism of Interfacial Polycondensation and the Direct Synthesis of Polyamide Membranes. *Am. Chem. Soc. Polym. Prep.*, **16**, 409-413.
- Barthes-Diesel, D. (1998) Mechanics of Encapsulated Droplets. *Progr. Colloid. Polym. Sci.*, **111**, 58-64.
- Walter, A., Rehage, H. and Leonhard, H. (2000) Shear-Induced Deformations of Polyamide Microcapsules. *Colloid. Polym. Sci.*, **278**, 169-175.
- Janssen, P.H., Noïk, C. and Dalmazzone, C. (2001) Emulsion Formation in a Model Choke-Valve. *SPE 71473, Annual Technical Conference and Exhibition*, New-Orleans, Louisiana, 30 September-3 October.
- Janssen, L.J.J.M. and Nijenhuis, K. (1992) Encapsulation by interfacial polycondensation. II: The Membrane Wall Structure and the Rate of the Wall Growth. *J. Mem. Sci.*, **65**, 69-75.
- Danicher, L., Gramain, P., Frère, Y. and Le Calvé, A. (1999) I: Synthesis, Characteristics and Properties of Milimetric Polyamide Capsules. *Reac. Func. Poly.*, **42**, 111-125.
- Malot, H., Noïk, C. and Dalmazzone, C. (2003) Experimental Investigation on Water-in-Crude Oil Emulsion Formation Through a Model Choke-Valve: Droplet Break-up and Phase Inversion. In: *Proceedings Multiphase Conference, BHR Group Multiphase Technology*, 543-559, San-Remo, 11-13 June.
- Duriez, G., Mouret, A., Noïk, C. and Papon, G. (2000) Méthode et dispositif de prélèvement d'une émulsion en circulation dans une conduite. *French Patent 00/12961*.
- Noïk, C. and Dalmazzone, C. (2002) Formation of Dispersions or Emulsions under Controlled Flow Conditions. In: *Proceedings 3rd North American Conference on Multiphase Technology*, Banff, Canada, 6-7 June, Sarica, C. and Gregory, G. eds., BHR Group Limited, 239-248.

Final manuscript received in October 2004