



HAL
open science

On Board Hydrogen Generation for Fuel Cell Powered Electric Cars. a Review of Various Available Techniques

M. Prigent

► **To cite this version:**

M. Prigent. On Board Hydrogen Generation for Fuel Cell Powered Electric Cars. a Review of Various Available Techniques. *Revue de l'Institut Français du Pétrole*, 1997, 52 (3), pp.349-360. 10.2516/ogst:1997045 . hal-02079121

HAL Id: hal-02079121

<https://ifp.hal.science/hal-02079121>

Submitted on 25 Mar 2019

HAL is a multi-disciplinary open access archive for the deposit and dissemination of scientific research documents, whether they are published or not. The documents may come from teaching and research institutions in France or abroad, or from public or private research centers.

L'archive ouverte pluridisciplinaire **HAL**, est destinée au dépôt et à la diffusion de documents scientifiques de niveau recherche, publiés ou non, émanant des établissements d'enseignement et de recherche français ou étrangers, des laboratoires publics ou privés.



Distributed under a Creative Commons Attribution 4.0 International License

ON BOARD HYDROGEN GENERATION FOR FUEL CELL POWERED ELECTRIC CARS

A REVIEW OF VARIOUS AVAILABLE TECHNIQUES

M. PRIGENT

Institut français du pétrole¹

**PRODUCTION D'HYDROGÈNE EMBARQUÉE
POUR VÉHICULES ÉLECTRIQUES À PILES**

APERÇU DE DIFFÉRENTES TECHNIQUES ENVISAGEABLES

Différents procédés permettant la production embarquée d'hydrogène pour véhicules électriques à piles à combustible sont passés en revue. Les combustibles primaires suivants sont considérés : ammoniac, méthanol, éthanol et hydrocarbures. Le craquage catalytique de l'ammoniac permet l'obtention d'un mélange à 75 % d'hydrogène, exempt de CO₂ et convenant donc sans purification ultérieure pour l'alimentation des piles alcalines. Avec ce combustible primaire, les problèmes sont la toxicité en cas de fuite et le risque de production d'oxydes d'azote lors de la combustion catalytique de l'effluent de la pile. Le méthanol, l'éthanol et les hydrocarbures liquides ou gazeux permettent également la production de mélanges riches en hydrogène, soit par vaporéformage catalytique, soit par oxydation partielle. Le gaz obtenu contient toutefois beaucoup de CO₂ et de CO et son usage nécessite un traitement d'épuration préalable. Sauf pour l'usage dans les piles à haute température, la concentration du CO doit être abaissée à un niveau très bas (quelques ppm). Le CO₂ peut toutefois être conservé pour l'alimentation des piles à électrolyte acide, son élimination n'étant nécessaire que pour les piles alcalines. La mise en œuvre de ces divers procédés est courante au niveau industriel. Mais la réalisation d'installations entièrement automatisées, de petite taille, acceptant des démarrages et des arrêts très rapides et fréquents ainsi que des variations permanentes de charge sans perte de rendement ni émissions de polluants, reste encore très délicate et incertaine.

**ONBOARD HYDROGEN GENERATION FOR FUEL CELL
POWERED ELECTRIC CARS**

A REVIEW OF VARIOUS AVAILABLE TECHNIQUES

Various methods allowing onboard hydrogen generation for fuel cell powered electric cars are reviewed. The following primary fuels are considered: ammonia, methanol, ethanol, and hydrocarbons. The catalytic cracking of ammonia allows generation of a CO₂-free mixture containing 75% hydrogen, which is consequently suitable without subsequent purification for the supply of alkaline fuel cells. The problems posed by this primary fuel are toxicity in the event of leaks and the risk of generating nitrogen oxides in the catalytic combustion of the cell effluent. Methanol, ethanol, and the liquid or gas hydrocarbons also allow the generation of hydrogen-rich mixes, either by catalytic steam reforming or by partial oxidation. The gas obtained in this way contains a large amount of CO₂ and

(1) Institut français du pétrole
1 et 4, avenue de Bois-Préau,
92852 Rueil Malmaison Cedex - France

CO, however, and its use requires a prior purification treatment. Except for use in high-temperature cells, the CO concentration must be reduced to a very low level (a few ppm). The CO₂, however, may be kept for the supply of acid electrolyte cells, although it must be eliminated for use with alkaline cells. All these methods are commonly used in industry, but the design of small fully automated facilities allowing fast frequent starting and stopping as well as continuous load variations without loss of performance or pollutant emissions is still a very delicate and uncertain matter.

PRODUCCIÓN DE HIDRÓGENO EMBARCADO PARA VEHÍCULOS ELÉCTRICOS CON CÉLULA COMBUSTIBLE.

COMPENDIO DE DIVERSAS TÉCNICAS PROYECTABLES

Se examinan sucesivamente diversos procedimientos que permiten la producción embarcada de hidrógeno para vehículos eléctricos con célula combustible. Se consideran así los combustibles primarios siguientes : amoníaco, metanol, etanol e hidrocarburos. El craqueo catalítico del amoníaco permite la obtención de una mezcla con un 75 % de hidrógeno, exento de CO₂ y, por consiguiente, adecuado sin purificación ulterior para la alimentación de las células alcalinas. Con este combustible primario, los problemas consisten en la toxicidad en caso de fugas y el riesgo de producción de óxidos de nitrógenos al producirse la combustión catalítica del efluente de la célula. El metanol, el etanol y los hidrocarburos líquidos o gaseosos permiten también la producción de mezclas ricas en hidrógeno, ya sea por vaporreformación catalítica, o bien, por oxidación parcial. No obstante, el gas obtenido contiene una importante proporción de CO₂ y de CO y su utilización requiere un tratamiento de depuración preliminar. Salvo para su utilización en las células de temperatura elevada, la concentración del CO se puede reducir a un nivel sumamente reducido (algunas ppm). No obstante, el CO₂ se puede conservar para la alimentación de las células alcalinas. La implementación de estos diversos procedimientos es ya corriente a nivel industrial. Pero la realización de instalaciones totalmente automatizadas, de pequeñas dimensiones, que puedan aceptar arranques y paradas muy rápidas y frecuentes, así como variaciones permanentes de carga sin disminución del rendimiento ni emisiones de contaminante, sigue siendo aún un problema delicado y sujeto a incertidumbres.

INTRODUCTION

Hydrogen is the only fuel currently suited to direct electric power generation in low-temperature fuel cell vehicles. It can be stored as compressed gas in high-pressure cylinders or liquefied at -253°C in cryogenic tanks. But these ways of storing hydrogen are somewhat heavy and bulky, hence difficult to fit into a vehicle, and not easily refillable. Furthermore there is no existing network for hydrogen transportation and local distribution [1]. The cost of pure hydrogen is also relatively high compared to the cost of conventional liquid fuels. The cheapest hydrogen available today, made from natural gas, has an on-site cost of about \$5.00 per gigajoule (i.e. \$0.16 per litre equivalent gasoline), whereas liquid hydrogen (delivered) now costs \$16.00 per gigajoule (i.e. \$0.64 per litre equivalent gasoline) [2]. Delivered, compressed hydrogen costs up to \$3.20 per litre equivalent gasoline, due to the weight of the cylinders transported along with it.

For future transportation needs it could therefore be more suitable to generate hydrogen on board from a primary fuel such as a fossil fuel (gasoline or diesel) or from a chemical intermediate (ammonia, methanol or higher alcohols).

Hydrogen is a widely utilized chemical whose industrial production has been considered common technology for over a century. Various processing options exist depending on the type of primary fuel considered and on the purity of gas needed (Table 1).

Today, in industry, most hydrogen is produced by steam reforming or partial oxidation of hydrocarbons (76% from natural gas and 23% from light or heavy oil distillates) [3]. But, for small hydrogen quantities, or when high-purity hydrogen is required, processes such as water electrolysis, ammonia decomposition or methanol reforming are also used. The largest consumption of hydrogen occurs in petroleum refining and in the petrochemical industries for ammonia and methanol synthesis (Fig. 1).

Many trade-offs for on-board hydrogen production therefore exist, both in the choice of fuel and in the choice of the process. The aim of this paper is to review the various technologies available, and to present some of the previous experience gained on internal combustion engine and fuel cell applications.

TABLE 1

Fuel production and processing for the various fuel cell types

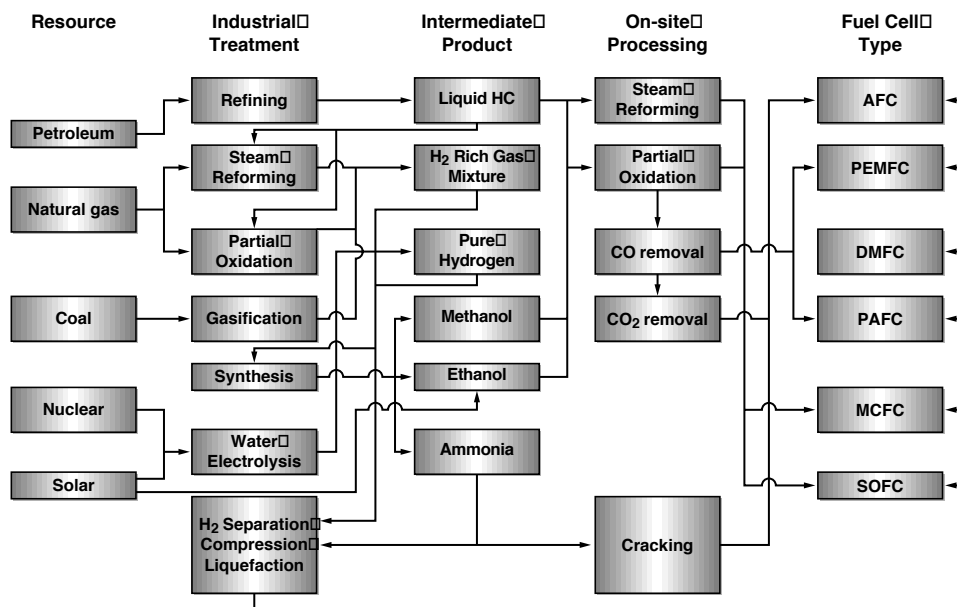

AFC: alkaline fuel cells; PEMFC: proton exchange membrane fuel cells; DMFC: direct methanol fuel cells; PAFC: phosphoric acid fuel cells; MCFC: molten carbonate fuel cells; SOFC: solid oxide fuel cells.

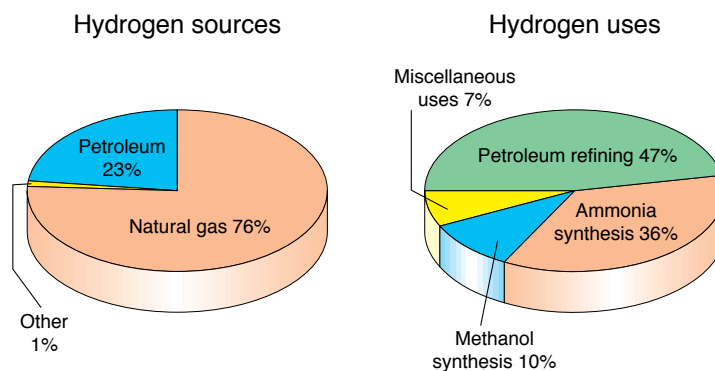

Figure 1
World production and utilization of hydrogen. From [3].

1 HYDROGEN PRODUCTION FROM AMMONIA

Ammonia heated in the presence of a suitable catalyst dissociates into nitrogen and hydrogen as shown below:



From the thermodynamics standpoint, the reaction (1) being endothermic and including a growth in the

number of molecules, increasing the temperature and lowering the pressure is in favour of ammonia decomposition. Nickel, iron or ruthenium supported on alumina can be used as catalysts. Computation shows that the minimum temperature required to achieve a high conversion rate is about 450°C (equilibrium conversion of 97% under 10 bar pressure leaving about 1.5% unconverted ammonia). Industrial crackers, however, generally operate at temperatures up to 900°C

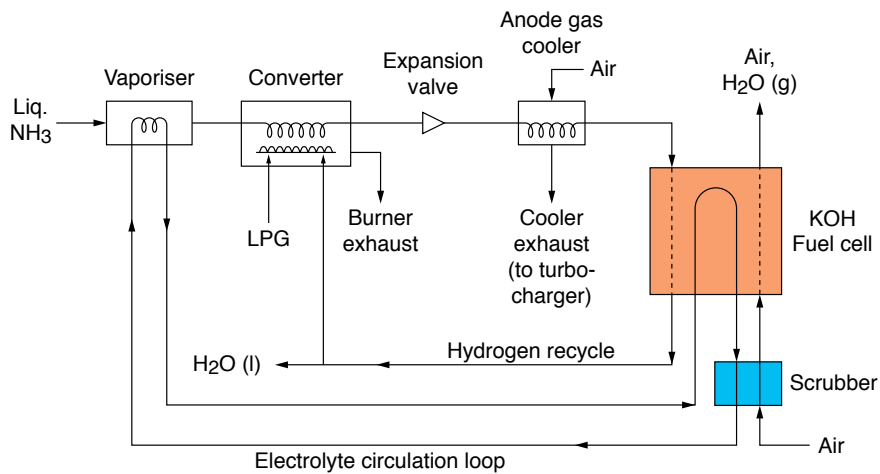

Figure 2

Flow diagram of an ammonia-air fuel cell system. From [4].

to lower the residual amount of ammonia to about 500 ppm. Pressure, for its part, in spite of its negative action on equilibrium, has a very favorable effect on reaction kinetics and consequently on reactor size and weight. Industrial units thus usually operate at pressures of between 2 and 10 bar.

With due account taken for the reaction endothermicity, the amount of energy required is about 12% of the high heating value (HHV) of H_2 without allowing for heat losses. It can be obtained by combustion of the fuel cell purge-gas as shown in Figure 2.

The dissociation product consists of around 25% nitrogen plus 75% hydrogen and some unconverted ammonia. It can be used directly in alkaline fuel cells [4-7] but needs further purification to remove the residual ammonia for fuel cells with acid electrolytes.

Using ammonia as a primary fuel in fuel cells has been considered for more than 30 years. But the main problems with ammonia reside in the need for pressurized tanks (it is stored in liquid form under 8.7 bar at 20°C), its toxicity in case of leakage, and the disposal of the unconverted ammonia residues. If sent to a catalytic burner, a high proportion of the unconverted ammonia will actually be converted into nitrogen oxide (Fig. 3) [8] and [9].

The problem of air pollution by NO_x would be then comparable to that raised by internal combustion engines.

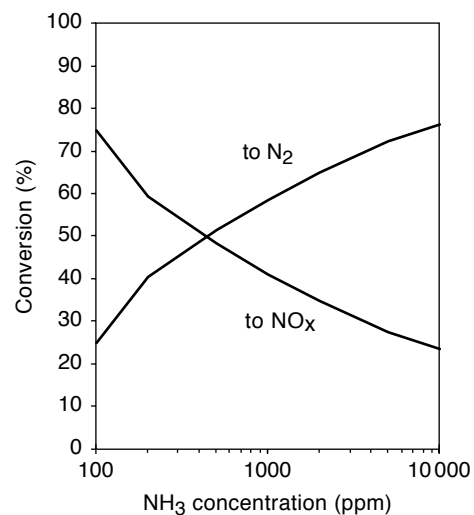
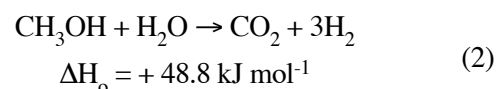

Figure 3

Ammonia catalytic oxidation rate into N_2 or NO_x at 500°C on an alumina supported palladium catalyst (400 ppm Pd), as a function of the ammonia concentration in air (GHSV = 30 000 h^{-1}) (IFP unpublished results).

2 HYDROGEN PRODUCTION FROM METHANOL

The basic reaction scheme of methanol steam reforming is as follows:



It can be considered, from the thermodynamics standpoint, as the combination of an endothermic methanol decomposition according to the reaction,



followed by the exothermic carbon monoxide shift conversion:



Steam reforming of methanol to produce hydrogen is not a new idea. In 1921, the Dane J.A. Christiansen discovered during his study of methanol synthesis that a $\text{CH}_3\text{OH} + \text{H}_2\text{O}$ mixture sent over reduced copper at 250°C was converted into a gas mixture containing three parts of hydrogen plus one part of carbon dioxide and was contaminated only by traces of carbon monoxide [10]. In 1930 and 1931, the same author published the results of his research on the reaction kinetics. The catalyst used in this study was a mixture of copper oxide and magnesium oxide, whose relatively rapid deactivation made the study particularly difficult [11] and [12].

The process concerning methanol steam reforming was first patented by A.T. Larson for *EI du Pont de Nemours* in 1943 [13]. In the patent the effect of temperature and of the steam/methanol ratio was disclosed. A chart showing the theoretical CO gas content as a function of these parameters is given (Fig. 4).

The catalysts claimed by A.T. Larson are coprecipitated mixed-oxides containing Zn-Cu, Zn-Cr-Cu or Cu-Mn. They are active in the $250\text{-}325^\circ\text{C}$ temperature range. It must be pointed out that during the Second World War several mobile hydrogen production units were built according to the Larson process and used by the US Army.

In 1951, *BASF* filed another application for a patent in Germany concerning high temperature (500°C) methanol steam reforming. The catalyst was zinc chromate with some minor quantities of group II, VI and VIII metals [14].

A reaction mechanism on copper catalysts, involving cupric ions, was proposed in 1960 by A. Krause [15].

After 1962 the number of publications increased due to renewed interest in methanol steam reforming for hydrogen fuel cell feed. Several studies on experimental modules were conducted for the US Army by *Engelhard Industries Inc.*, *The Kellogg Cy*, and *Girdler Corporation* [16-18].

Engelhard studied the reaction of methanol-water mixtures on platinum at 538°C and hydrogen separation with palladium membranes. The *Kellogg Cy* worked on Larson's Cu-Mn catalyst for supplying hydrogen to a 200 kW submarine fuel cell (Fig. 5).

In Girdler's study, the possibility of creating an autothermal process by oxygen addition to the reactants was considered but abandoned because of technological

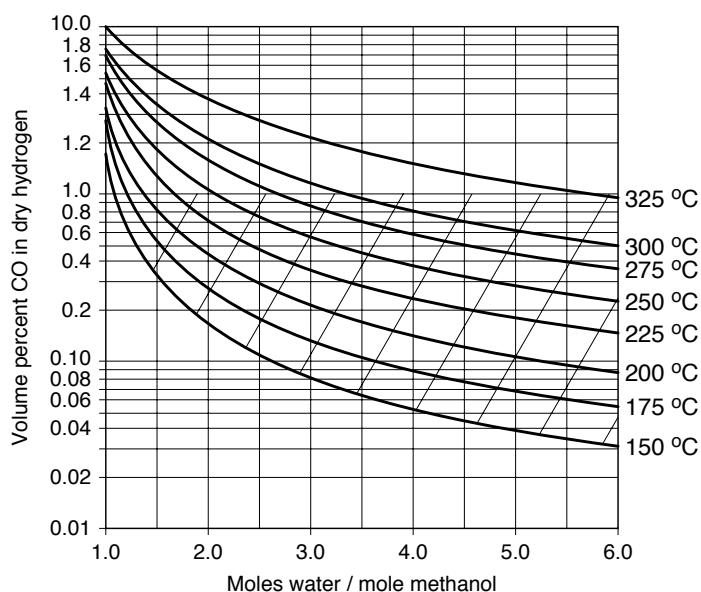

Figure 4

Theoretical CO concentration in hydrogen obtained by methanol steam conversion, as a function of temperature and water to methanol ratio in the feed gas. From [13].

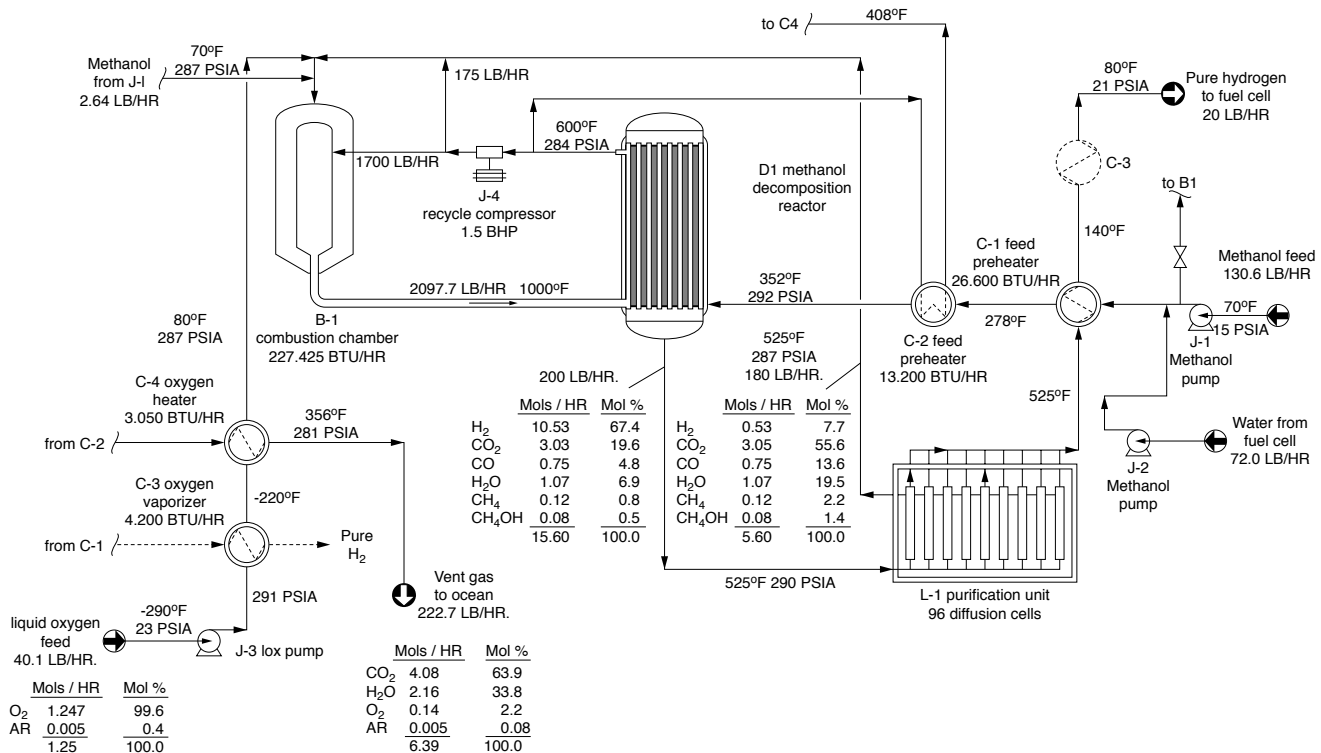

Figure 5

Process flowsheet for methanol steam conversion and hydrogen purification established for a 200 kW submarine fuel cell by *The Kellogg Co* in the USA. From [18].

difficulties. Various catalytic formulations containing: Cu-Mn, Cu-Cr-Zn, Cu-Ni-Fe, Cu-Cr, Cu-Co, Cu-Mn, Cu-Fe, Fe-Cu-Ni or Fe-Cr-Ni were evaluated and the product gas analyzed.

In 1964, *Union Carbide* designed a methanol steam reformer including a hydrogen separator using palladium membranes [19]. The catalysts, working at 370°C, were of two types: a platinum-based catalyst plus a base-metal catalyst, whose composition was not disclosed.

Several other patents appeared in the mid sixties [20-24].

In France, research on methanol steam reforming was also undertaken at *IFP* in the mid-sixties [25-29]. The goal was to design a generator able to supply pure hydrogen to an alkaline hydrogen-air fuel cell. The chosen method consisted in a three-step operation:

- methanol steam reforming at about 250°C on a specific unsupported Cu-Cr catalyst;
- carbon dioxide removal with a small-scale diethanolamine scrubber;

- residual carbon monoxide and carbon dioxide elimination by methanation at about 400°C on a Ni-Cr catalyst.

In the early 70s, small integrated converters able to supply purified hydrogen to 500 watt or 2000 watt hydrogen-air alkaline fuel cells were available (Figs. 6 and 7). The system's overall thermal efficiency ranked between 45 and 60%.

New developments are underway in various laboratories [30-35]. The *Argonne National Laboratory*, *Johnson Matthey* and the *Jülich Research Centre (KFA)*, for example, recently disclosed their development of small hydrogen generators for acid fuel cells. The *Argonne* on-board methanol reformer is claimed to be small enough to fit under the hood of a compact car beside a 50 kW PEM fuel cell, i.e. a volume of around 25 litres “less than a seven-gallon container”.

The *KFA*'s methanol experimental reformer includes a catalytic burner to provide the heat required for the reaction (Fig. 8). In the start-up phase, methanol is sent

In *Johnson Matthey's* new hydrogen generator, methanol steam-reforming and partial oxidation are combined. Named "Hot-Spot™", this reactor works as an autothermal reformer. Full-sized units consist of modular assemblies of individual reactors. Their number can be varied according to the hydrogen output required. They have the shape of a small cylinder 12.5 cm long with a diameter of 5 cm. Their volume is 245 cm³ and they weigh 580 g. Each module can produce 480 l/h of hydrogen. The start-up time is less than 2 minutes. Under normal autothermal operation, the overall chemical reaction is as follows:

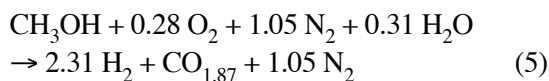

The carbon monoxide content of the gas obtained is around 2.5%, which is far too high for the normal operation of a proton exchange membrane fuel cell (PEMFC). It can be reduced to 1% by increasing the water content in the reactant feed. But a CO-removal system, based on selective oxidation, is under development to bring the concentration down to 5 ppm.

The detrimental effect of carbon monoxide on PEMFC performance was demonstrated recently by Lemons [36]. With only 20 ppm CO the current density at 0.6 volt is divided nearly by two, and by four with 100 ppm (Fig. 9).

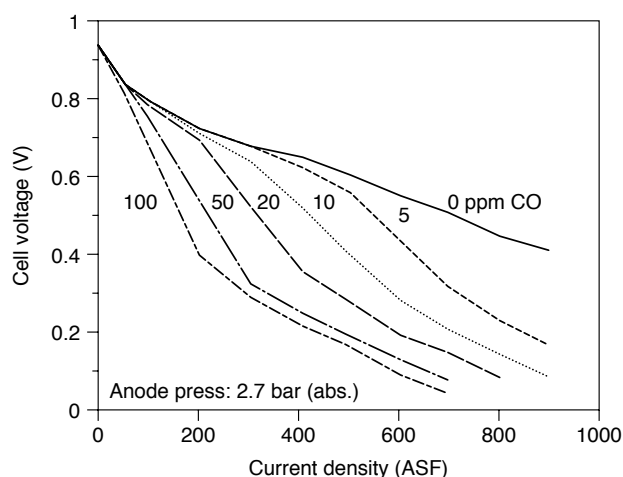

Figure 9

Cell voltage as a function of current density in a PEMFC: effect of the hydrogen carbon monoxide content between 0 and 100 ppm. From [36].

Contaminants other than CO are also present in the converter effluents, such as traces of unconverted methanol, formaldehyde, formic acid, methyl formate, etc. and are also likely to alter fuel cell performance. Formic acid, for example, was shown to produce severe and irreversible poisoning [37].

Another important point, often overlooked in most of the published works dealing with methanol steam reforming, concerns methanol purity. It was actually observed in our previous experiments that copper catalysts working at temperatures of about 250°C are quite sensitive to higher alcohols frequently present in small quantities in industrial methanol grades. Ethanol, for example, is dehydrogenated into acetaldehyde, which can poison the catalyst by polymerization on the catalyst surface. This problem can be avoided at higher working temperatures as will be seen below, but more CO will be present in the product gas.

3 HYDROGEN PRODUCTION FROM ETHANOL

The overall ethanol steam reforming reaction can be represented by the following equation:

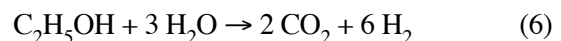

The feasibility of the above reaction was studied on a thermodynamic basis in two recent papers [38] and [39]. In practice the steam reforming of ethanol generates many by-products, and the following reactions must also be taken into account:

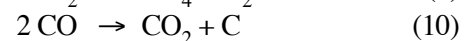
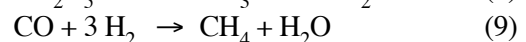
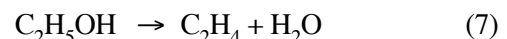

It was demonstrated by García and Laborde that, compared to methanol steam reforming, higher temperatures and water-to-ethanol ratios are needed. The theoretical production of methane, for example, should decrease when the temperature increases and when the pressure and water-to-ethanol ratio decrease (Fig. 10).

In order to obtain the best hydrogen output, minimizing carbon monoxide and methane production, and avoiding carbon deposition on the catalyst, they therefore suggest to operate at $T > 380^\circ\text{C}$, atmospheric pressure and with a water-to-ethanol ratio of up to 10 in the feed.

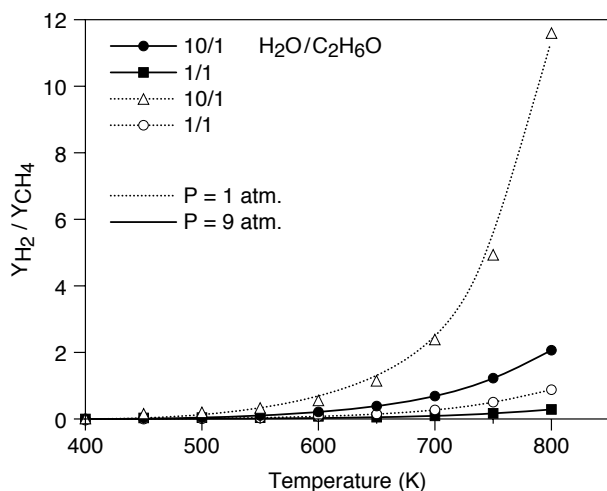

Figure 10

Ethanol steam-reforming: hydrogen to methane molar fractions vs temperature at different pressures and water to ethanol ratios. From [3].

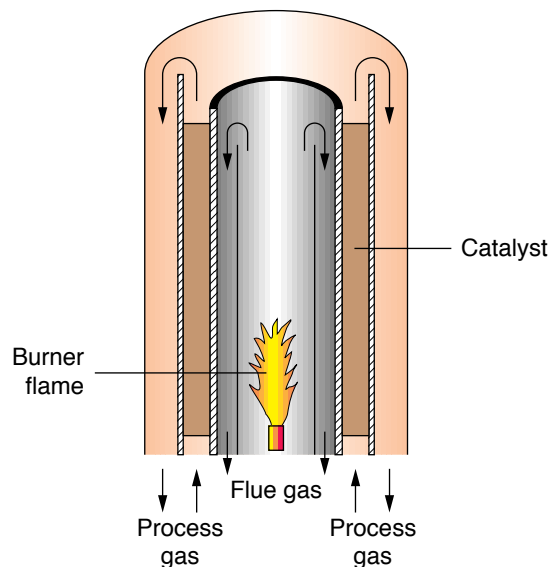

Figure 11

Schematic of an annulus-type catalytic bed for hydrocarbon steam reforming. From [3].

Vasudeva *et al.* have computed that equilibrium hydrogen yields as high as 5.5 mole per mole of ethanol in the feed can be obtained at around 500-600°C with water-to-ethanol ratios of above 20, as compared to the stoichiometric value of 6 given by equation (6).

Several catalyst types were evaluated for ethanol steam reforming by Cavallaro and Freni [40]. They found that CuO-ZnO/Al₂O₃ or NiO-CuO/SiO₂ catalysts exhibit good activity. At $T < 327^{\circ}\text{C}$ the reaction produces relatively high proportions of oxygenated compounds i.e. 30-70% acetaldehyde, 5-15% ethyl acetate, and 0-30% acetic acid. Operation at $T > 377^{\circ}\text{C}$ reduces the amount of these by-products to mere traces except for CH₄. Another by-product of the reaction is CO, which is found in the effluents at concentrations of 10 to 20%. A shift conversion reaction, at a lower temperature, is then necessary later.

4 HYDROGEN PRODUCTION FROM HYDROCARBONS

Steam reforming of hydrocarbons is the most commonly used method in industry for hydrogen production [3, 41, 42]. In this process hydrocarbons and steam react at elevated temperature in a first catalytic bed to form carbon monoxide and hydrogen. Steam

reforming of gasoline may be represented by the following chemical equation:

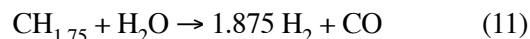

The reformer effluent is then passed through a second catalytic bed, where carbon monoxide is converted at low temperature into hydrogen, according to the well-known shift-conversion reaction (equation (4) above).

Reaction (11) is strongly endothermic ($\Delta H > 200 \text{ kJ mol}^{-1}$ for CH₄) and requires external heat input. This is done in industrial units by filling the catalyst in tubes immersed inside the radiant section of a furnace where heat is exchanged directly between the flame and the tube wall. In small-sized power plants specifically designed for fuel cells, the catalyst is most frequently located inside a low thickness cylindrical annulus surrounding a burner, as shown in Figure 11. The amount of energy required is typically of the order of 22% of the liquid fuel lower heat of combustion.

Industrial steam reformers use nickel-based catalysts requiring high temperatures in the range of 800-900°C to achieve acceptable conversions. With a steam-to-carbon ratio of 3.5, methane conversions up to 98% are obtained at moderate pressure. The reforming catalysts are however very sensitive to poisoning by elements such as sulphur, chlorine or heavy metals. The

feed gas must be then treated prior to entering the reformer in order to remove the contaminants. One major point is the need to avoid the risk of carbon deposition on the catalyst itself and in the downstream equipment due to the Boudouard reaction during the effluent gas cooling (reaction (10) above).

Another way to promote hydrocarbon steam reforming consists in the partial oxidation process [43, 44]. The generation of hydrogen from gasoline may be represented here by the following chemical equation:

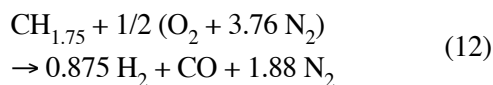

The reaction heat, rather than coming through the reactor tube walls, is produced here by adding a controlled quantity of air in the feed to promote the combustion of part of the hydrocarbons. When a catalyst is used the operating temperature can be lower than the steam reforming temperature, i.e. between 600 and 800°C. It is also possible to operate in a refractory-lined thermal reactor without catalyst but at temperatures in excess of 1000-1100°C (e.g. the *Texaco* and *Shell* processes).

Partial oxidation has the following advantages versus steam reforming:

- It provides a simplified system without the need for external water and heat supply.
- The transient response characteristics are improved since there is no heat transfer process involved.
- The soot production propensity is reduced, which facilitates the use of heavy (liquid) hydrocarbons.

In return, the produced gas contains residual nitrogen; furthermore, the partial oxidation being an exothermic reaction, about 17% of the low heating value of the fuel is lost.

The influence of the air-fuel ratio on product gas composition obtained with indolene ($\text{CH}_{1.92}$) was determined from chemical equilibrium computation by Houseman and Cerini (Fig. 12). They showed that the optimum air-fuel ratio, maximizing hydrogen production, is close to 5.2/5.4. At lower air-fuel ratios, methane and soot are obtained, and above, the production of carbon dioxide and water occurs to the detriment of hydrogen production. Here, thermal efficiency of the conversion into hydrogen would be around 80%.

As previously stated for methanol, partial oxidation and steam reforming can be combined to utilize the exothermic partial oxidation heat to promote the

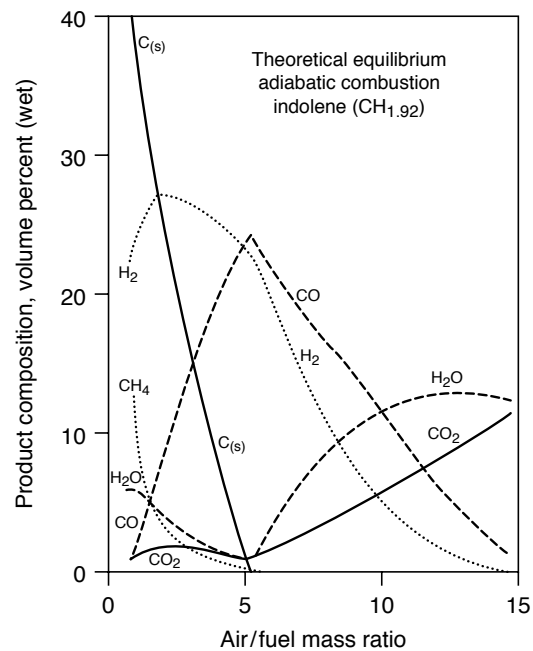

Figure 12

Product distribution as a function of the air-fuel ratio in partial oxidation of gasoline. From [44].

endothermic steam reforming reaction. In 1974 at the *Jet Propulsion Laboratory*, Houseman and Cerini developed a compact reactor for internal combustion engines able to convert an air-gasoline-water mixture into a hydrogen-rich gas. The reactor used a nickel-based catalyst working at 980°C. The product gas contained 22% H_2 , 24% CO , 1% CH_4 , 0.1% C_2H_4 , 1% CO_2 , 1% H_2O and 50.9% N_2 . No carbon production was observed.

Whatever the process used, steam reforming, partial oxidation or combined partial oxidation plus steam reforming, the gas obtained has a carbon monoxide content which is much too high for direct use in most fuel cells except for high-temperature fuel cells (MCFC or SOFC). A further steam shift-conversion of CO is necessary. It can be performed in one or two steps depending on the maximum acceptable residual CO level. To lower the concentration to about 1-2%, which is acceptable for phosphoric fuel cells for example, a CO shift catalyst composed of iron and chromium mixed oxides is in common use. It operates at about 350-400°C. When CO in the product gas has to be reduced further, a low-temperature copper-zinc catalyst operating at 200-250°C must be used.

CO concentration can be then brought down to a few hundred ppm. This level is however still too high for low-temperature fuel cells (AFC or PEMFC), and a third processing is needed to reduce it to a few ppm. Two methods are presently considered: selective oxidation or methanation.

CONCLUSIONS

A wide variety of processes is available for hydrogen production from gaseous or liquid fuels. They differ according to the nature of the primary fuel used (ammonia, methanol, ethanol, gaseous or liquid hydrocarbons) and to the chemical reactions involved (decomposition, steam reforming or partial oxidation).

Several of these processes are commonly used in industry. But for on-board fuel cell powered electric car applications, specific selection criteria must be considered.

- First of all, the primary fuel has to be easy to handle, non-toxic and competitive from an economical point of view.
- Second, the process must be technically easy to down-size, able to be fully automated, adaptable to frequent startups and shutdowns, sufficiently flexible to respond rapidly to changes in fuel cell demands corresponding to normal stop-and-go driving, and, last but not least, energy-efficient.
- In addition, the final hydrogen product must be convenient for use in fuel cells according to their type, i.e. a near-absence of CO for working temperatures below 150-180°C, and of CO₂ for cells with an alkaline electrolyte.
- Lastly, the process must be emission-free in steady-state or transient conditions, as well as during startup and shutdown. Hence, if the converter gaseous effluents have to be depolluted before emission, the time necessary for system startup should be very short. It is in fact presently known that internal combustion engines can have very low pollutant emissions in steady-state conditions, provided they are equipped with a suitable catalytic muffler. If they still produce excessive emissions, these occur only during the 2 or 3 first minutes of engine running after a cold start and also in the event of inadequate control of the system during transients.

On the basis of the above considerations, one can conclude that on-board hydrogen production is

certainly feasible from a technical standpoint. But it is far from evident that it could simply replace pure hydrogen, stored in compressed tanks or liquefied, while keeping the benefits of fuel cells from the point of view of efficiency and still preserving the environment from pollution.

REFERENCES

- 1 Bréelle Y., P. Gélin, C. Meyer and G. Petit (1979), Technico-economic study of distributing hydrogen for automotive vehicles. *Int. J. Hydrogen Energy*, **4**, pp. 297-314.
- 2 Appleby A.J. (1993), Characteristics of fuel systems. In *Fuel cell systems*, Ed. L.J.M.J. Blomen and M.N. Mugerwa, Plenum Press, NY, pp. 157-199.
- 3 Pietrogrande P. and M. Bezzeccheri (1993), Fuel processing. In *Fuel cell systems*, Ed. L.J.M.J. Blomen and M.N. Mugerwa, Plenum Press, NY, pp. 121-156.
- 4 Ross P.N. Jr (1981), Characteristics of an NH₃-air fuel cell system for vehicular applications. *Proc. 16th Intersoc. Energy Conf.*, Atlanta 1981, **1**, pp. 726-733.
- 5 Strickland G. (1981), Small-scale uses and costs of hydrogen derived from OTEC ammonia. *Proc. 16th Intersoc. Energy Conf.*, Atlanta, **2**, pp.1459-1467.
- 6 Metkemeijer R. and P. Achard (1994), Ammonia as a feedstock for a hydrogen fuel cell; reformer and fuel cell behaviour. *J. Pow. Sources*, **49**, pp. 271-282.
- 7 Metkemeijer R. and P. Achard (1994), Comparison of ammonia and methanol applied indirectly in a hydrogen fuel cell. *Int. J. Hydrogen Energy*, **19**, 6, pp. 535-542.
- 8 Martin L., M. Prigent and R. Vaucher (1973) (unpublished results), Étude de laboratoire de l'activité de quelques catalyseurs de postcombustion pour l'oxydation de l'ammonia. *IFP Report No. 21 362*, May 1973.
- 9 Gandhi H.S., H.C. Yao, H.K. Stepien and M. Shelef, *Evaluation of Three-Way Catalysts, Part III - Formation of NH₃, its Suppression by SO₂ and Reoxidation*.
- 10 Christiansen J.A. (1921), A reaction between methanol and water and some related reactions. *J. Amer. Chem. Soc.*, **43**, pp. 1670-1672.
- 11 Christiansen J.A. and J.R. Huffman (1930), The reaction between methanol and steam as an example of heterogeneous catalysis. *Z. Physik. Chem.*, A **151**, pp. 269-302.
- 12 Christiansen J.A., Use of the method of stationary velocities for the reaction CH₃OH + H₂O → 3H₂ + CO₂. *Z. Physik. Chem.*, Bodenstein-Festband, pp. 69-77.
- 13 Larson A.T (1947), *US Pat. 2 425 625*, 12 Aug. 1947.
- 14 Rabe H. and H. Lohmeyer (1953), *Ger. Pat. 877 746*, 26 May 1953.
- 15 Krause A. (1960), *Bull. Acad. Polon. Sc., Ser. Chim.* **8**, pp. 255-256.
- 16 Engelhard Industries (1964), *Final Report*, No. AD 462 470, Sept. 1964.
- 17 Girdler corporation (1962), *Report No. AD 292 273*, Oct. 1962.
- 18 The Kellogg Cy (1962), *Report No. AD 292 134. Adv. Chem. Ser.*, Sept. 1962, **47**, 318.
- 19 Rothfleisch J.E. (1964), (Union Carbide Cy), Hydrogen from methanol for fuel cells. *SAE preprint 935 C*.

- 20 Holmes P.D. and A.R. Thornhill, *French Pat.* N° 1 390 776 and 1 391 625.
- 21 Brown Boveri and Co., *French Pat.* No. 1 410 732.
- 22 Kordesch K.V. and G.E. Evans, *French Pat.* No. 1 417 757.
- 23 Kordesch K.V., *French Pat.* N° 1 417 758.
- 24 Bowen M.D. and J.T. Hamrick, *US Pat.* No. 3 179 500.
- 25 Prigent M., A. Sugier and O. Bloch (1968), Theory and kinetics of methanol reforming; Use in calculating the reactor associated with a hydrogen cell. *Proc. Int. Fuel Cells Symposium*, Dresden, 1967, Akademie-Verlag, Berlin, pp. 267-276.
- 26 Prigent M., C. Dezael and O. Bloch (1967), Emploi du méthanol comme source d'hydrogène pour les piles à combustible. *Proc. Les piles à combustible, 2^e Journées internationales d'étude*, Bruxelles.
- 27 Bloch O., C. Dezael and M. Prigent (1969), Méthode d'obtention d'hydrogène pur pour l'alimentation d'une pile à combustible à partir du méthanol. *Proc. Les piles à combustible, 3^e Journées internationales d'étude*, Bruxelles, pp. 286-290.
- 28 Prigent M., C. Dezael and Y. Breelle (1970), Technology of pure hydrogen generators using methanol and the new application prospects they create for hydrogen-air cells. *5th Intersoc. Energy Conf., paper 709082*, Las Vegas, **1**, pp. 5111-5116.
- 29 Bréelle Y., O. Bloch, P. Degobert and M. Prigent (1972), *Principes, technologie, applications des piles à combustibles*, Éd. Technip, Paris, pp 70-81.
- 30 Kurpit S.S. (1975), 1.5 and 3kW indirect methanol-air fuel cell power plants. *Proc. 10th Intersoc. Energy Conf.*, Newark, pp. 222-228.
- 31 Amphlett J.C., M.J. Evans, R.A. Jones, R.F. Mann and R.D. Weir (1981), Hydrogen production by the catalytic steam reforming of methanol. *Can. J. Chem. Eng.*, **63**, pp. 720-727.
- 32 Amphlett J.C., K.A.M. Creber, J.M. Davis, R.F. Mann, B.A. Peppley and D.M. Stokes (1994), Hydrogen production by steam reforming of methanol for polymer electrolyte fuel cells. *Int. J. Hydrogen Energy*, **19**, 2, pp. 131-137.
- 33 Schmidt V.M., P. Brökerhoff, B. Höhle, R. Menzer and U. Stimming (1994), Utilization of methanol for polymer electrolyte fuel cells in mobile systems. *J. Pow. Sources*, **49**, pp. 299-313.
- 34 Argonne National laboratory (1995), *Fuel Reformer Brings Practical Electric Cars Closer*, Aug. 8, 1995, Internet, news950808.htm.
- 35 Golunski S.E. (1996), Hydrogen generation for mobile applications. *1996 Summer Workshop, Fuel cells and the Car of Tomorrow*, Jülich, 5 June 1996.
- 36 Lemons R.A. (1989), Fuel cells for transportation. *Proc. First Grove Fuel Cell Symp.*, London, Sept. 1989, p. 251.
- 37 Seymour C.M., O.A. Belsey, R.A.J. Dams and S.C. Moore (1992), The development of a proton exchange membrane fuel cell power system. *Fuel Cell Seminar*, Tucson, Arizona, Nov. 1992.
- 38 García E.Y. and M.A. Laborde (1991), Hydrogen production by the steam reforming of ethanol: thermodynamic analysis, *Int. J. Hydrogen Energy*, **16**, 5, pp. 307-312.
- 39 Vasudeva K., N. Mitra, P. Umasankar and S.C. Dhingra (1996), Steam reforming of ethanol for hydrogen production: thermodynamic analysis. *Int. J. Hydrogen Energy*, **21**, 1, pp. 13-18.
- 40 Cavallaro S. and S. Freni (1996), Ethanol steam reforming in a molten carbonate fuel cell. A preliminary kinetic investigation. *Int. J. Hydrogen Energy*, **21**, 6, pp. 165-169.
- 41 Houseman J. and G.E. Voecks (1981), Hydrogen engines based on liquid fuels-A review. *Proc. 3rd World Hydr. Energ. Conf.*, Tokyo, **2**, Pergam. Press, Oxford, pp. 949-968.
- 42 Steinberg M. and H.C. Cheng (1988), Modern and prospective technologies for hydrogen production from fossil fuels. *Proc. 7th World Hydr. Energ. Conf.*, Moscow, **2**, pp. 699-739.
- 43 Houseman J. and D.J. Cerini (1976), On-board hydrogen generator for partial hydrogen injection internal combustion engine. *SAE paper 760600*.
- 44 Houseman J. and D.J. Cerini (1976), On-board hydrogen generation for automobiles. *Proc. 11th Intersoc. Energy Conf., State line, paper 769001*, pp. 6-16, .

Final manuscript received in January 1997