



HAL
open science

Novel Additive for Particulate Trap Regeneration

L. Bergonzini, P. Morelli, J. B. Dementhon, B. Martin, P. Richards, M. Rush,
D. Williams

► **To cite this version:**

L. Bergonzini, P. Morelli, J. B. Dementhon, B. Martin, P. Richards, et al.. Novel Additive for Particulate Trap Regeneration. *Revue de l'Institut Français du Pétrole*, 1997, 52 (4), pp.441-452. 10.2516/ogst:1997052 . hal-02079126

HAL Id: hal-02079126

<https://ifp.hal.science/hal-02079126>

Submitted on 25 Mar 2019

HAL is a multi-disciplinary open access archive for the deposit and dissemination of scientific research documents, whether they are published or not. The documents may come from teaching and research institutions in France or abroad, or from public or private research centers.

L'archive ouverte pluridisciplinaire **HAL**, est destinée au dépôt et à la diffusion de documents scientifiques de niveau recherche, publiés ou non, émanant des établissements d'enseignement et de recherche français ou étrangers, des laboratoires publics ou privés.



Distributed under a Creative Commons Attribution| 4.0 International License

NOVEL ADDITIVE FOR PARTICULATE TRAP REGENERATION

J.-B. DEMENTHON and B. MARTIN

Institut français du pétrole¹

P. RICHARDS, M. RUSH and D. WILLIAMS

OCTEL Engine Laboratory²

L. BERGONZINI and P. MORELLI

Ansa³

UN NOUVEL ADDITIF POUR LA RÉGÉNÉRATION DES FILTRES À PARTICULES DIESELS

Une des voies les plus prometteuses pour la régénération des filtres à particules diesels consiste à additiver le carburant avec des composés organo-métalliques. Cet article s'intéresse à un nouveau dérivé alcalin, capable de favoriser des régénérations spontanées pour des températures à l'échappement descendant jusqu'à 200 °C, et pour des teneurs en métal aussi faibles que 5 ppm. Des essais ont été réalisés sur un réacteur à suies et sur un moteur au banc, avec différentes localisations des filtres à l'échappement, montrant que le déclenchement de la régénération dépend de la température, de la masse de suie accumulée dans les structures poreuses et des conditions opératoires du moteur. Le nettoyage complet du filtre nécessite encore des températures de gaz supérieures à 400 °C, qui peuvent être atteintes lors des fonctionnements à fortes charges du moteur.

NOVEL ADDITIVE FOR PARTICULATE TRAP REGENERATION

One of the most promising ways to insure the periodic regeneration of a particulate trap, consists to additise the fuel with organo-metallic compounds. The present paper deals with a novel alkali product, able to promote natural regenerations, for exhaust temperatures as low as 200°C, and treatment rates as low as 5 ppm. Tests have been carried out on a soot reactor and on an engine bench with various trap locations in the exhaust showing that the regeneration occurrence depends on temperature, soot mass loaded inside the porous structure, engine conditions. A complete trap cleaning still needs gas temperatures up to 400°C, which can be encountered for high load conditions of the engine.

NUEVO ADITIVO PARA REGENERACIÓN DE LOS FILTROS DE PARTÍCULAS DE MOTORES DIESEL

Una de las soluciones más prometedoras para la regeneración de los filtros de partículas de los motores diesel consiste en una adición del carburante por medio de compuestos organo-metálicos. En este artículo se trata de un nuevo derivado alcalino, capaz de propiciar las regeneraciones espontáneas para temperaturas de escape que descienden hasta los 200 °C, y para concentraciones de metal tan reducidas como 5 ppm. Se han efectuado diversas pruebas en un reactor de hollines y en un motor en banco de pruebas, con diversas localizaciones de los filtros en un escape, demostrando así que cuando se produce la regeneración ello depende de la temperatura, de la masa de hollines acumulada en las estructuras porosas y de las condiciones operativas del motor. La limpieza completa del filtro requiere también temperaturas de gas superiores a 400 °C, que se pueden alcanzar cuando el motor funciona con fuertes cargas.

(1) 1 et 4, avenue de Bois-Préau,
92852 Rueil-Malmaison Cedex - France

(2) The Associated Octel Company Limited,
Engine Laboratory,
Watling Street Bletchley,
Milton Keynes MK1 1EZ - United Kingdom

(3) Ansa Marmite S.p.A.,
41034 Finale Emilia (Modena) - Italy

* This article was presented at the *SAE Fuels and Lubricants Meeting and Exposition*, Toronto, October 16-19, 1995.

INTRODUCTION

The endurance of light-duty diesel vehicles depends on the ability of technologists to solve the crucial problem of particulates. As a matter of fact, recent studies tend to classify the particulate matter as potential carcinogenic substance, especially the IOF (insoluble organic fraction) part of particulate, rather than the matter adsorbed on soot, as PAH, for instance. In order to respond to this environmental concern, more and more stringent standards have appeared all around the world, for particulate limitation. Modern diesel vehicles should be able to match the 1996 European particulate emission standards but, the suspected 2000 standards encourage the development of additional after-treatment technologies. The most efficient technique to remove particulates from exhaust gas is known to be the trap, with an IOF collection efficiency ranging from 70 up to more than 90%. This technology, which has been studied for years [1], never came to extended production, essentially because of the need for a periodic regeneration which makes the system costly, hard to control, and with a trap durability affected by frequent thermal stresses occurrence. A promising way to overcome this difficulty is to use the catalytic action of organo-metallic fuel additives. This method is known to be much more efficient than the catalytically coated trap. As a matter of fact, the substance promoting soot oxidation is closely trapped with organic matter. The literature reports some studies about several famous compounds, used as additives for trap regeneration, based on transition metals, as ferrocene, copper naphthenate, or rare earth as cerium octoate [2, 3, 8]. Furthermore, some other studies were devoted to alkali compounds, as lithium or sodium, for instance, because of their low suspected toxicity [4] and [13].

The difficulties of fuel additivation can be defined as follows :

- necessity for an on board fuel/additive mixing device;
- toxicity risks if the product cannot be trapped in the porous structure, because of creating too small size particles, or in case of trap failure;
- additive ash accumulation in the trap, leading to average backpressure increase and associated fuel consumption penalty.

A limitation of additive treatment rate in the fuel, constitute a potential response to the two last concerns.

The purpose of this paper is to present the performances of a new sodium based product, obtained with a novel chemistry, not referenced as a toxic compound and thought to be efficient at treatment rates as low as 5 ppm. Tests have been carried out apart from the engine on one hand and on an engine bench, in engine steady state conditions, on the other hand, for various locations of the trap relative to the engine.

1 REGENERATION TEMPERATURE

The performances of an additive for trap regeneration are usually assessed through the measurement of an ignition temperature. With that respect, the reference used to classify additive relative efficiencies, is the soot ignition temperature measured without additive, classically ranging between 500°C and 600°C [5].

For practical reasons, the soot burning temperature is of great importance, because it determines the additional power supply devices needed for regeneration for a given vehicle and driving pattern. In other words, it influences the cost and the complexity of the after treatment system. The determination of this temperature, depends highly on the experimental technique employed. In some cases, this value is established thanks to a fundamental experiment, carried out apart from the engine. Particulates are sampled from diesel exhaust, put in a relevant reactor, heated and the start of oxidation is pointed out by detecting the sample weight decrease start (TGA—Thermo Gravimetry Analysis—technique [6]), or the CO and CO₂ releases [7]. In some other studies, the particulate combustion is assessed directly with an engine bench experiment. A trap is first loaded with particulates. Then, the gas temperature is enhanced by increasing engine load, up to the point where the exhaust backpressure created by the fouled trap stops to increase. This temperature is often called the equilibrium temperature. In other cases, after a loading period of the trap, the regeneration is triggered thanks to an additional device (burner or heater) [8], without changing engine conditions, up to the point where exhaust backpressure starts to decrease because of soot oxidation. Generally, such experimental procedures lead to evidence additive benefits between 100°C and 200°C, that is a trap regeneration starting at 350°C, for the most efficient additive cases. This temperature can still be quite scarcely encountered in diesel exhaust, especially during urban driving cycles. However, the experimental approaches previously

described, do not figure the whole complexity of the phenomena. In practical cases, several studies show the occurrence of what have been called stochastic regenerations elsewhere [4] and [9], due to additives for temperature as low as 200°C, when the trap is set in a real exhaust, close to the engine. This phenomenon is usually detected by measuring the abrupt and random decrease of exhaust backpressure due to particulate burning. To resume, it appears that additive performance assessment, depends highly on experimental conditions.

That is why we have decided to study the performances of our novel additive with three different experimental approaches.

First, as a preliminary work, we have studied the combustion of two soot samples, with and without additive, in a reactor blown by a gas including oxygen, in order to determine a fundamental particulate ignition temperature. Then, we have compared the regeneration of a trap set in the exhaust of an engine installed on a bench, with and without additive. First the trap has been set far from the engine, after a huge gas heater used to trigger regeneration. This configuration has permitted to determine the temperature of a complete regeneration in a more real environment. At last, we have installed the trap very close to the engine in order to highlight the stochastic regeneration phenomenon.

2 REACTOR EXPERIMENT

Prior to this study, some substances were selected from alkaline metal and alkaline earths. Such substances were known to influence the mass-growth, coagulation and oxidation of soot [13]. In the frame of this study, we have selected the sodium among those candidates, because of its good compromise between efficiency and toxicity. The additive manufactured, clearly had to be fuel soluble and stable during its life as a concentrate on a vehicle or blended in the fuel handling chain. The additive was also required to decompose quickly following discharge from the fuel injector and be "action ready" in the engine combustion space. The additive was prepared using novel chemistry. Metal compounds used were based on beta di-ketonates, with a Lewis base donor compound.

In the work presented here, the additive treatment rate used is 5 ppm weight of metal (2.6×10^{-4} mole/liter), which is a very low value, compared to what is

often reported in the literature about current transition metal additives [2] and [3].

The experiment described below had been initially developed by G. de Soete [7] to establish the reaction rates of additised soot.

Figure 1 hereafter represents a schematic view of the reactor set-up.

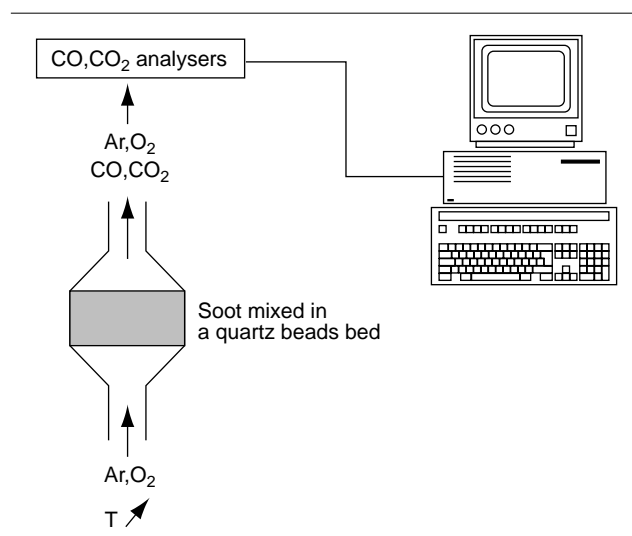

Figure 1

Schematic view of the fixed bed apparatus.

A sample of soot is taken from a diesel exhaust and deposited on a filter. In the two cases (additised and non additised fuel), the engine is running at 3000 RPM (round per minute) and 90 Nm, the exhaust temperature is close to 500°C, which produces a low SOF (Soluble Organic Fraction) rate in the matter. Each sample is mixed in a quartz beads bed which insure a fast extraction of the heat released by combustion, so as to keep the sample temperature homogeneous. A gas at a flow rate of 36×10^6 m³/s, containing argon and oxygen (8,25%), is passed through the reactor. The temperature of the bed is increased at a 10°C/minute rate. The gas flowing out of the reactor are analysed by CO and CO₂ NDIR (Non Dispersive Infra Red) analysers.

Figure 2a and 2b, display the CO and CO₂ release rates versus gas temperature, without additive and with 5 ppm of Na, respectively.

First, we notice that the CO and CO₂ curves reach their maximum value at 630°C without additive, whereas the maximum is reached at 430°C with 5 ppm of Na additive, so a benefit of 200°C, if we consider this criterion to determine the regeneration temperature.

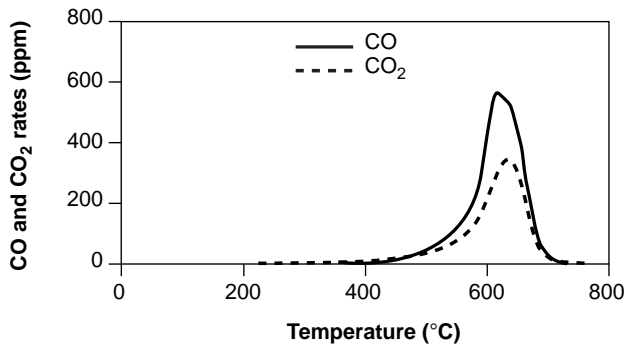

Figure 2a

CO and CO₂ releases without additive
(courtesy of J. Roessler, *IFP*).

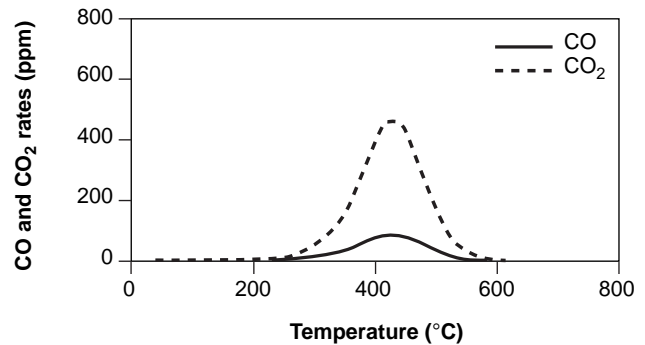

Figure 2b

CO and CO₂ releases with 5 ppm of Na
(courtesy of J. Roessler, *IFP*).

Secondly, the presence of the organo-metallic compound, promotes the release of CO₂, compared to the CO, indicating a fundamental change in the chemical process, because of the lower temperature of reaction. At last, it appears that the curve is much wider in the sodium case. As a matter of fact the oxidation is proved to begin under 300°C, the CO₂ starts to release around 250°C. In the non additised case, the oxidation starts at 400°C, but the reaction rate is really significant over 500°C. The width of those oxidation curves, illustrate the difficulty to determine an ignition temperature in a practical configuration, where the regeneration start detection, will depend on particulate emission rate, quantity of adsorbed hydrocarbons, O₂ rate, thermal transfers which depend on trap design and fouling pattern.

[10, 11, 12]. They are built with Nextel ceramic fibres wound around a punched steel tube. Such trap is known to be a so-called deep bed filter, which means that the matter penetrates inside the porous structure created by the fibre frame, before to be trapped.

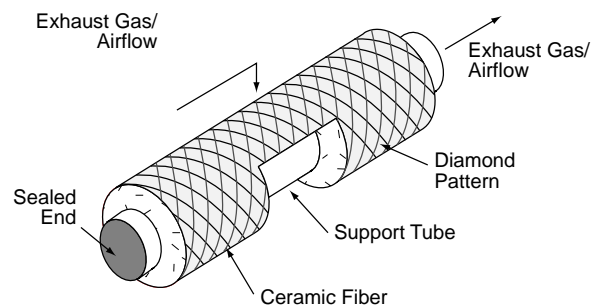

Figure 3a

3M cartridge (from [11]).

3 TRAP REMOTE FROM THE ENGINE

3.1 Experimental set-up

The engine used for the tests is a Renault J8S whose main characteristics are given hereafter:

number of cylinders:	4
displacement:	2068 cc
bore:	86 mm
stroke:	89 mm
compression ratio:	21.5
maximum power:	45.5 kW @ 4500 RPM
maximum torque:	12.4 m.daN @ 2250 RPM.

The trap used in this experiment is based on 3M cartridges. This kind of cartridges, represented Figure 3a, have been frequently reported in the literature

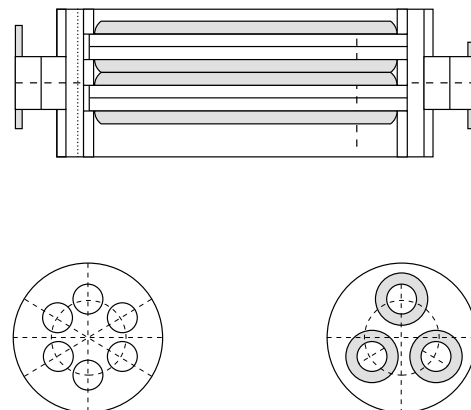

Figure 3b

Trap canning.

The trap used in this study has been built with 3 cartridges installed at 120° (Fig. 3b).

A schematic view of the engine bench is displayed in Figure 4.

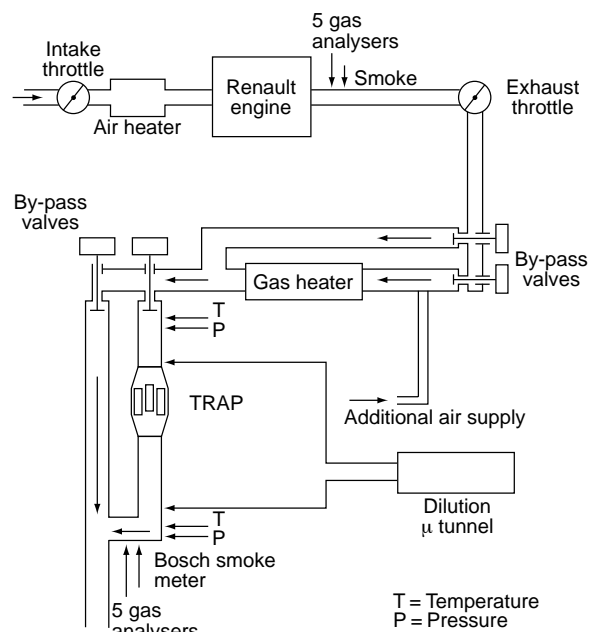

Figure 4
Engine bench set up.

The trap is set downstream of a huge gas heater, used to trigger the regeneration. A 5 gas analysis rack Horiba permits to measure CO, CO₂, HC, NO_x and O₂. The measurement set comprises also a Bosch smoke analyser as well as two dilution microtunnels for particulate measurements. In this last compact measurement device, the air supply for dilution occurs inside the sampling probe itself. The diluted gas are passed through a pallflex teflon coated filter, where particulates deposit. The filter is then weighed after conditioning before and after heating in an oven at 210°C, in order to measure IOF and SOF parts of particulates. All of those devices permit to perform measurements, both upstream and downstream of the trap.

Two characteristic steady engine conditions have been chosen:

- 2000 RPM, 30 Nm - T = 200°C, upstream of the clean trap, referenced as 2000/30 in the following;
- 3000 RPM, 90 Nm - T = 400°C, upstream of the clean trap, referenced as 3000/90 in the following.

Those two fouling conditions correspond to either "hot" (high load) or "cold" (low load) conditions of the engine. Morphology, nature and particulate deposit pattern change versus engine conditions, because they are influenced by gas temperature, oxygen rate and gas velocity. On the other hand, the range (200°C to 400°C) corresponds to the desorption of heavy hydrocarbons. Hence, it appears that the accumulated matter will be dryer and more difficult to ignite in the second case.

3.2 Additive impact on emissions

First of all, we have studied the influence of additive at 5 ppm on engine performances, for a clean trap in the two cases described previously, in particular pollutant emissions (Table 1). As a matter of fact, additives, have often been reported to act on particulate formation. There are usually two processes explaining additive action on soot [4]: the first one is a promotion of OH radicals transfer; the second one, attributed to alkali in particular, consists in an electrostatic charge transfer, limiting agglomeration of elementary particles in big clusters. This last feature permits to keep the surface/volume ratio higher, that helps oxidation.

TABLE 1

Influence of additive on engine performances

	Without additive	Without additive	With Na (5 ppm)	With Na (5 ppm)
Engine charac.	2000/30	3000/90	2000/30	3000/90
Consumption (kg/h)	2.34	7.7	2.33	7.8
HC (g/h)	7.8	5.7	6.8	5.9
CO (g/h)	20.9	14.8	21.2	14.2
CO ₂ (kg/h)	5.2	10.8	5.0	10.8
NO _x (g/h)	23.4	66.7	21.9	63
Air/fuel ratio	0.27	0.59	0.29	0.59
Exhaust temp. (°C)	203	500	213	511
Bosh smoke index	0.69	0.93	0.54	0.88
IOF (g/h)	0.83	3.2	0.59	2.86
SOF (g/h)	0.57	1.3	0.5	1.3

The data displayed in Table 1 show that the only significant influence of additive on engine performances is a reduction of IOF emissions by ~30% at low load (2000/30 case) and 10% at high load (3000/90 case). The lower reduction rate at high load corresponds to the lower O₂ rate, that makes the additive effect unefficient. SOF and HC rates remain equivalent.

This aspect is important with respect to regeneration characteristics, which could be influenced by adsorbed hydrocarbon trapped. Additive seems to have negligible effect on consumption, which implies that the modifications of the combustion process inside the combustion chamber only influence the soot growth and oxidation.

3.3 Additive and filtration characteristics

The filtration characteristics have been assessed for the two above mentioned engine conditions, the fouling time before regeneration is set to a duration corresponding to a loading of 15 grams of IOF matter in the non additised case. This duration is established thanks to particulate measurements carried out in both cases (IOF and SOF rates are shown in Table 1). In the 2000/30 case, the loading duration is 18 hours, in the 3000/90 case, 4 hours and 30 minutes. The assessment of trap performances consists in studying the compromise between filtration efficiency and exhaust back pressure. The first aspect witnesses directly the ability of the device to remove particulates from exhaust gas, the second aspect is related to engine efficiency penalty.

Table 2, hereafter gathers some data about the filtration characteristics. The collection efficiency is calculated on the basis of particulate matter sampled upstream and downstream of the trap with microtunnel.

TABLE 2
Filtration characteristics

		Without additive		With Na 5 ppm	
		2000/30	3000/90	2000/30	3000/90
Collection efficiency (%)	IOF	75	80	70	85
	SOF	50	60	66	65
Pressure drop (mbar)	Clean trap	15	40	15	32
	End of fouling	350	420	240	250

The collection efficiency lies between 70% to 85% for IOF, 50% and 65% for SOF, depending on engine conditions. In case of IOF, the collection efficiency increases with engine speed which is a normal behaviour for a clean deep bed filter. Sodium seems to have a slight positive effect on collection efficiency, may be due to the change in particulate size

distribution, caused by the electron charge transfer modification.

The pressure drop across the trap increases with speed and load, according to Darcy's law. As a matter of fact, the pressure drop is proportional to gas velocity. This last parameter depends on gas mass flow rate (engine speed) and temperature. Additive has an effect on pressure drop: at the end of the fouling process, this parameter is lower in the additised case. This feature is partly due to the reduction of particulate emissions.

The description of the fouling process, is completed by the trap pressure drop curves represented in our four experimental cases in Figure 5a and Figure 5b, below.

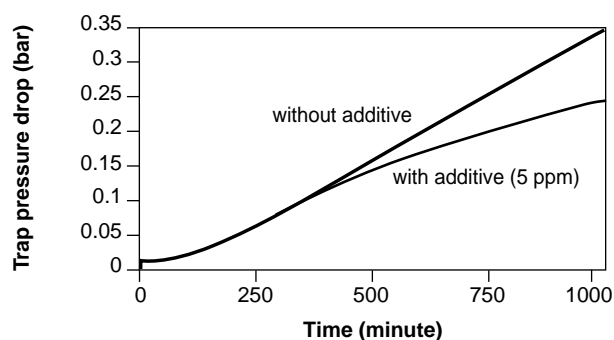

Figure 5a

Fouling characteristics - with Na (5 ppm) and without additive - 2000/30.

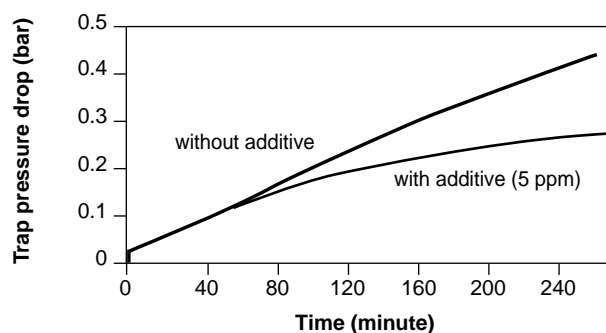

Figure 5b

Fouling characteristics - with Na (5 ppm) and without additive - 3000/90.

First, we observe that, without additive, the fouling curves (thick lines) show some different patterns between 2000/30 and 3000/90. In the low velocity case (2000/30), the fouling curve reach a linear behaviour. In the high velocity case (3000/90), the curve shows a saturation pattern. This is explained by the filtration

principle involved. The fibre trap acts as an agglomerator, fostering the agglomeration of particles into clusters. When those agglomerates reach a critical size (which depends on gas velocity), they tend to be dragged out of the trap.

In both additised cases (thin lines), the curves diverge from the non additised curves (pressure drop ~ 150 mbar). This can be explained partly by the lower particulate emission in the additised cases, but also by the fact that, even at low temperature (2000/30, $T \sim 230^\circ\text{C}$), oxidations start inside the trap, if the matter (both carbon, hydrocarbon and metal) loaded is sufficient. This shows a benefit of additive as the fuel consumption penalty is minimised.

Despite the high temperature level in the second case (400°C upstream of the trap, that is 380°C , inside the filtering medium), the evolution of pressure drop does not show any stochastic regeneration, in that experimental configuration.

3.4 Forced regeneration

When the fouling duration is over, a procedure for regeneration is triggered, without changing engine conditions. The heater forces the gas temperature to increase continuously with a $35^\circ\text{C}/\text{minute}$ rate, in order to trigger the regeneration of the trapped matter. Figures 6a, b, c represent the forced regeneration characteristics (pressure drop, CO and CO_2 releases), in the 2000/30 case.

In this case, the pressure first shows a slight decrease due to HC desorption between 200°C and 400°C . Then, the pressure drop increases again because the oxidation rate does not overcome the natural increase of pressure drop with temperature. The ignition temperature is defined when the pressure drop starts to decrease until the complete cleaning of the trap (as indicated in Figure 6a and 7a).

As noticed in the frame of the reactor experiment the use of additive induces a higher rate of CO_2 , and a faster reaction rate proved by the narrower shape of the CO and CO_2 releases.

Figures 7a, b, c, represent the forced regeneration characteristics (pressure drop, CO and CO_2 releases), in the 3000/90 case.

In the 3000/90 case, there is no effect of SOF desorption because of the high temperature inside the trap.

Without additive, the regeneration temperature is lower in the 2000/30 case, compared to the 3000/90 case (480°C , Figure 6a, rather than 490°C , Figure 7a). This may be explained by a promoting effect of heavy hydrocarbons trapped with the soot, in the first case. We define the regeneration duration as the delay necessary for the backpressure to reach its minimum value from the time it starts to decrease. The regeneration duration is shorter in the 3000/90 case compared to the 2000/30 case (200 seconds rather than 500 seconds). This is a clear effect of the higher gas flow rate at 3000 RPM. This can be explained also by the faster combustion occurring at higher temperature.

With additive, in both engine conditions, 2000/30 and 3000/90 (Figure 6a and 7a), the regeneration temperature is the same: 430°C , which represents an higher benefit in 3000/90 than in 2000/30. This could mean that the catalytic effect of additive only influences IOF oxidation. The regeneration temperature determined in the additised case, corresponds to the temperature of CO and CO_2 maximum values, detected in the reactor experiment.

The combustion durations are comparable in additised cases compared to non additised cases, on the contrary of what is often reported with Copper or Iron, for instance [8]. This aspect can be regarded as a benefit, because it means that the combustion promoted by sodium at 5 ppm, would be smoother and would lead to lower thermal stress inside the trap structure.

In the 3000/90 case, the trap pressure drop reached at the end of regeneration is close to the pressure drop measured in a clean trap case. In the 2000/30 case, it appears slightly higher. As a matter of fact the temperature is about 600°C inside the trap at the end of the regeneration, rather than 250°C at the end of the fouling duration. According to Darcy's law, the temperature influences gas density, i.e. gas velocity, i.e. pressure drop. In both cases, anyway, it can be deduced that the completeness of regeneration is satisfactory.

The level of 430°C measured upstream of the trap, corresponds to 400°C inside the trap itself. In a real driving cycle, once this temperature will be reached, a regeneration will be triggered and completed if engine conditions stabilise for 3 to 6 minutes. This temperature is obtained for 2000 RPM, 90 Nm or for 3000 RPM, 80 Nm conditions, that correspond to acceleration or motorway driving.

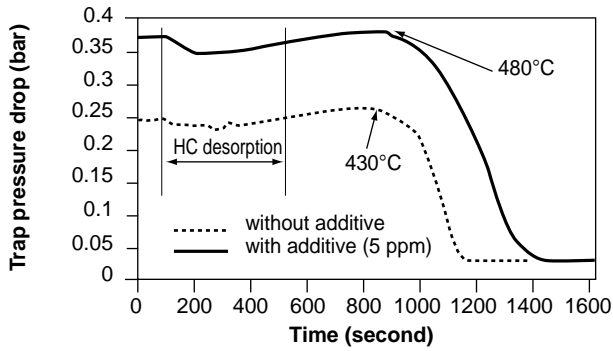

Figure 6a
Regeneration profile - with Na, 5 ppm and without additive.

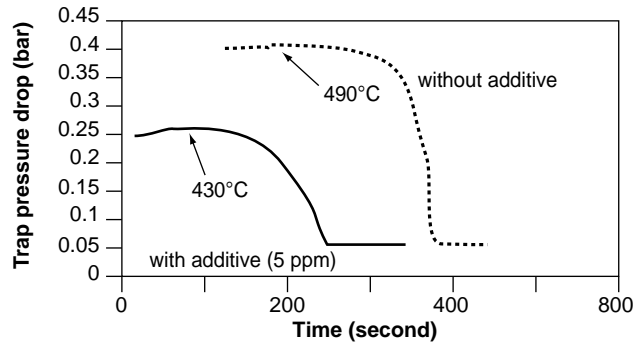

Figure 7a
Regeneration profile - with Na, 5 ppm and without additive - 3000/90

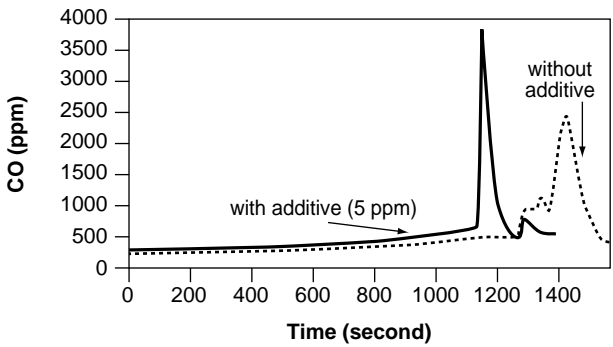

Figure 6b
CO released by soot burning.

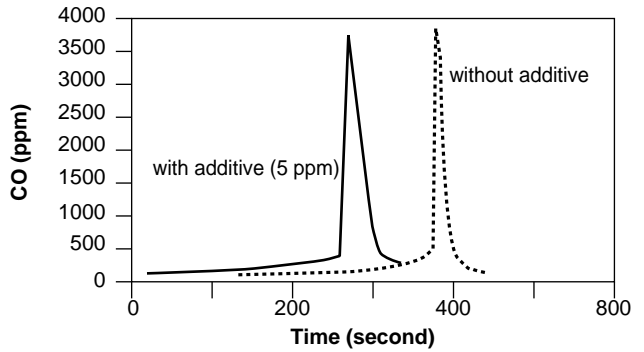

Figure 7b
CO released by soot burning.

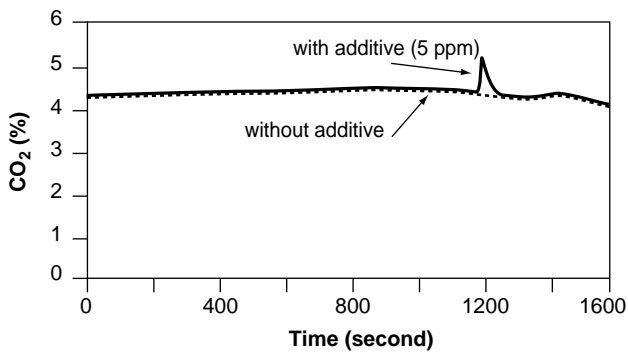

Figure 6c
CO₂ released by soot combustion.

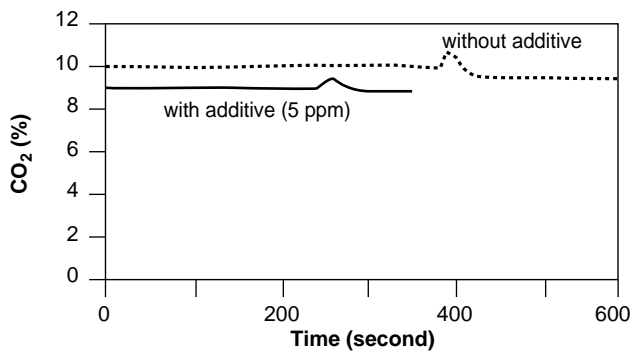

Figure 7c
CO₂ released by soot burning.

4 STOCHASTIC REGENERATIONS

In order to simulate more accurately what occurs in a real vehicle, the trap has been set immediately downstream of the engine. This configuration has often been reported to enhance the benefit of additives, by producing stochastic regenerations at low temperature.

This new implementation is represented in Figure 8.

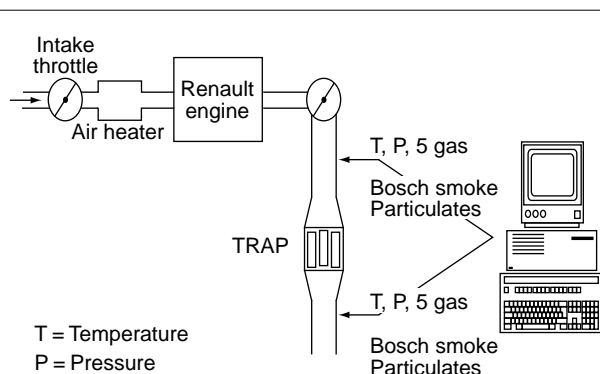

Figure 8

Schematic view of the new trap implementation.

In this experiment, a set of 9 thermocouples (cartridge 1 = A, B, C, cartridge 2 = D, E, F, cartridge 3 = G, H, I) has been implemented inside the trap, in touch of the ceramic surface of each cartridge (Fig. 9), in order to follow the burning process.

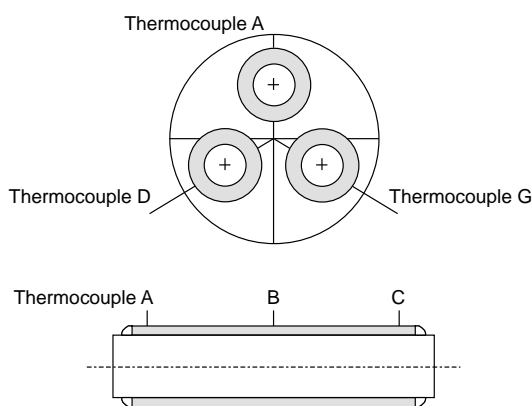

Figure 9

Thermocouples implementation.

At 3000/90, in this new configuration, we could not obtain any increase of trap pressure drop, because of a continuous oxidation of the matter. As a matter of fact

the temperature measured upstream of trap was over 450°C, because of the trap located close to the exhaust. We then tried two other engine conditions, 2000/60 ($T = 300^{\circ}\text{C}$ upstream of the trap in clean conditions, Figure 10a) and 2000/30 ($T = 200^{\circ}\text{C}$ upstream of the trap in clean conditions, Figure 10b). In both cases, the pressure drop trace shows a tooth-peak pattern, characteristic of stochastic regenerations occurrence. It appears that, even when the temperature of gas entering the filtering system is as low as 230°C, soot oxidation is permitted. This is confirmed by the CO release detected in the 2000/60 case, as well as the increase of downstream temperature. The concept of regeneration temperature stops to be relevant to represent fully the phenomenon. The random aspect of the oxidation process appears clearly. Particularly in the 2000/30 case, the duration between two regenerations is no longer constant, no more than the maximum trap pressure drop reached. One can observe that the trap pressure drop obtained at the end of the stochastic regeneration is not constant, and higher than the level measured at the beginning of the fouling process, particularly in the colder case (2000/30 Fig. 10b). This indicates that the cleaning of the trap is not completed. The slope of the fouling curve observed confirms this impression. After a regeneration, the fouling rate detected is much higher.

Figures 11a and 11b permit to study the stochastic regeneration more in details. Two stochastic regenerations are represented, regeneration 1 (Fig. 11a) and 2 (Fig. 11b) in the same steady state conditions, at 2000/30. Both regenerations have been detected in the same test at different times. Apparently, what distinguishes those two regenerations is the trap pressure drop at the beginning of combustion. In the first case (Fig. 11a) this pressure drop is 260 mbar, in the second case (Fig. 11b), it has reached 340 mbar. In both cases, the pressure decay is very abrupt at the beginning, but is progressively attenuated. This shape is very different than in forced regeneration (Fig. 6a and 7a), where the burning process starts slowly and accelerate because of gas temperature increasing rate, and because of a quite homogeneous heat release, inside the medium. During a stochastic regeneration occurring at low gas temperature, the gas supply does not permit to sustain the burning phenomenon, as it does in a complete regeneration, but takes energy from combustion, limiting its propagation. This explains why the regeneration will scarcely be completed, in those cold case. In the first case of regeneration (Fig. 11a), only

one thermocouple detects a rising of temperature, in cartridge 1, at the bottom of the cartridge. One can figure out that a small part of one cartridge is cleaned because soot ignition is very local. After this partial combustion, the flow rate distribution is no longer homogeneous but suddenly encouraged across the cleaned region. This phenomenon modifies deeply the filtration characteristics of the trap just after the regeneration, which appears in particular through the fact that the fouling rate detected then is very high compared to the fouling rate of a clean trap (Figure 10b). One can suspect that the nature of soot deposit will be very different in this particular combustion, compared to the fouling pattern of the rest of the trap. This phenomenon creates completely new conditions for the next regeneration, which explains partly that the phenomenon seems to change from a regeneration to another. As soon as the cleaned region has been loaded again, the fouling rate measured tends towards its former value.

In regeneration No. 2 (Fig. 11b), every thermocouples detect a rise of temperature, the combustion is more complete, undoubtedly due to the higher particulate load before regeneration (100 mbar higher than regeneration No. 1). The pressure drop reached at the end of regeneration 2 is lower than at the end of regeneration 1. In this case, the burning pattern is slightly different, namely because the combustion appears to occur later at the bottom of the cartridges. The fouling rate measured after the end of regeneration is much lower because a greater part of the trap has been cleaned. Nevertheless, the temperature measured during combustion does not exceed 400°C, which is

slightly under the temperature measured for complete regeneration in the previous section.

SUMMARY AND CONCLUSION

A novel additive based on sodium, blended to fuel at 5 ppm, has been tested with several experimental procedures, figuring the regeneration pattern. This product, at this treatment rate, cannot be suspected of toxicity.

The following conclusions can be drawn.

- The sodium permits to reduce IOF emissions up to 30% at low load. In addition to this raw benefit, this implies that the fouling rate of the trap is lower, as well as the fuel consumption penalty due to exhaust back pressure.
- A complete cleaning of the trap can be obtained at 50°C to 80°C under the regeneration temperature measured without additive. However, the combustion remains smooth which reduces the risks for trap destruction, at high temperature.
- At temperature as low as 230°C, the system leads to stochastic and local regenerations. In practical use, the trap will not clog and the maximum backpressure induced will remain limited.
- The concept of regeneration temperature can not be regarded as an absolute criterion. What is more relevant is the temperature that induces a complete cleaning of the trap. This value can be approached by experiments led in reactors, or directly in engine benches. However it does not represent the whole complexity of the phenomenon. The stochastic

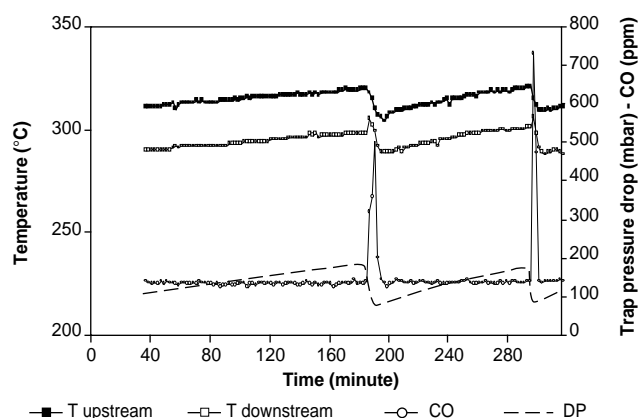

Figure 10a

Stochastic regenerations 2000/60.

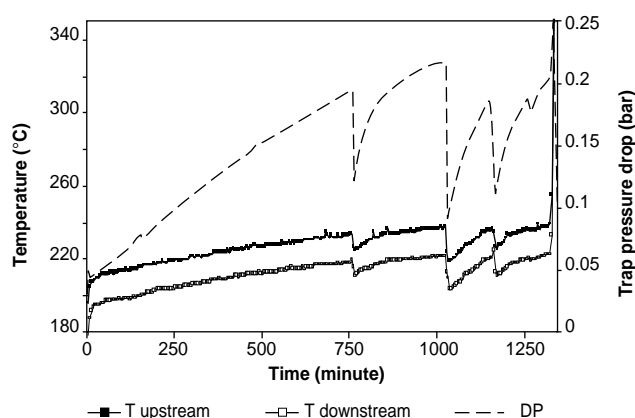

Figure 10b

Stochastic regenerations 2000/30.

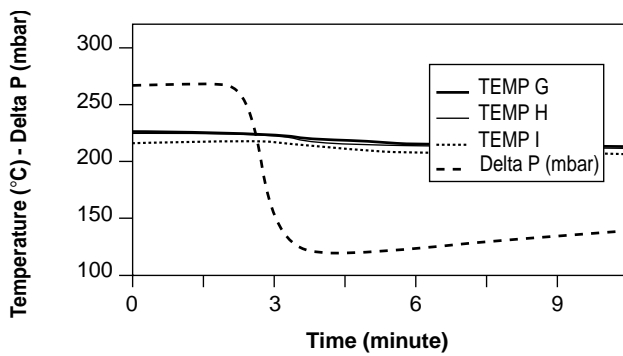
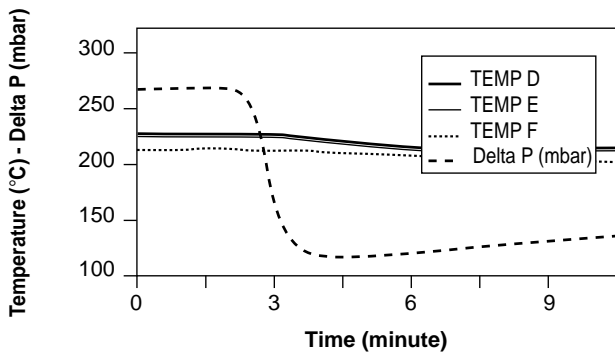
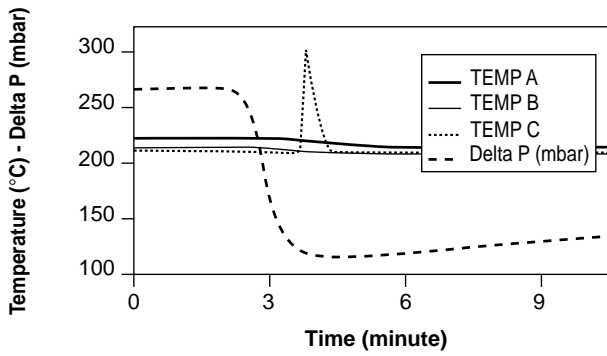

Figure 11a
Stochastic regeneration 1. Temperatures inside the trap - 2000/30.

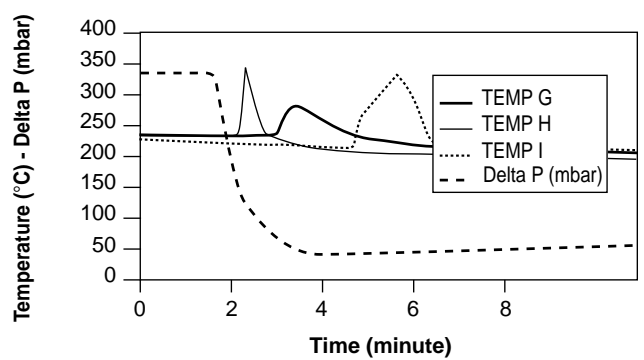
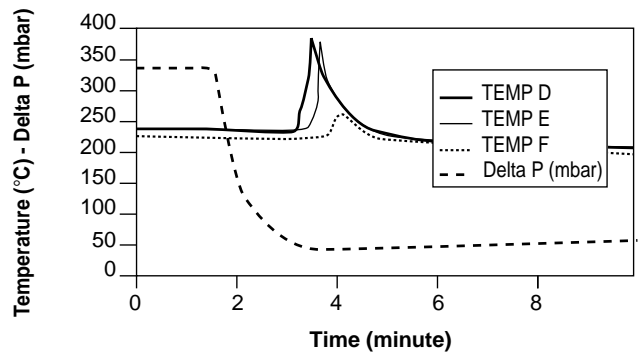
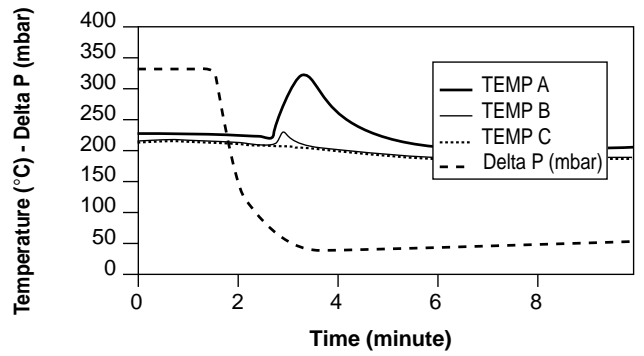

Figure 11b
Stochastic regeneration 2. Temperatures inside the trap - 2000/30.

regeneration needs to be understood through a more complete set of parameters, for instance gas temperature, trap load, O₂ ratio in gases. There is some need for a fundamental understanding of additive catalytic efficiency in real use.

- A part from a safety or OBD II point of view, the after-treatment device based on particulate trap can be designed without any artificial regeneration control. However, some controlling strategies can be added to the system in order to lower the average backpressure or liming heat release and thermal stress inside the trap.

ACKNOWLEDGEMENTS

This work has been partly funded by the *European Commission*, within the framework of Joule II programme.

We wish to thank greatly Dr J. Roessler for his contribution and scientific advises about the fundamental experiment.

We wish to thank M. O. Pajot who has performed the engine tests.

REFERENCES

- 1 Johnson J.H. *et al.* (1992), A review of diesel particulate control technology and emissions effects. Horning Memorial Award Lecture, SAE 940233.
- 2 Mac Kinnon D.L. *et al.* (1994), Results of North American field trials using diesel filters with a copper additive for regeneration, SAE 940455.
- 3 Pattas K. *et al.*, and J. Lemaire (1992), Cordierite filter durability with cerium fuel additive: 100 000 km of revenue service in Athens. SAE 920363.
- 4 Krutzsch B. and G. Wenninger (1992), Effect of sodium and lithium based fuel additives on the regeneration efficiency of diesel particulate filters. SAE 922188.
- 5 Gilot P. (1990), Interprétation théorique et modélisation de la combustion des suies sur filtre à particules diesels. *Thèse de doctorat*, université de Haute Alsace, France.
- 6 Bonnefoy F. (1992), Destruction des polluants carbonés et des oxydes d'azote dans les conditions d'un échappement diesel : étude expérimentale et théorique. *Thèse de doctorat*, université de Haute Alsace, France.
- 7 de Soete G. (1987), Combustion catalytique des suies diesels, *Internal report IFP* n° 35586.
- 8 Martin B. and D. Herrier (1990), Efficiency of fuel additive on diesel particulate trap regeneration. *IMEchE*.
- 9 Lepperhoff G., H. Lüders, P. Barte and J. Lemaire (1995), Quasi-continuous particle trap regeneration by cerium additives. SAE 95036.
- 10 Garner C.P. and J.C. Dent (1988), A thermal regeneration model for monolithic and fibrous diesel particulate traps. SAE 880007.
- 11 Bloom R. (1995), The Development of fiber wound diesel particulates filter cartridges. SAE 950152.
- 12 Shirk R., R. Bloom, Y. Kitahara and M. Shinsawa (1995), Fiber wound electrically regenerable diesel particulate filter cartridge for small diesel engines. SAE 950153.
- 13 Haynes B.S. *et al.*, The effect of metal additives on the formation of soot in rich pre-mixed flames. *Nineteenth Symposium (International) on Combustion*, p. 1379.

Final manuscript received in June 1997