



HAL
open science

Major Scientific and Technical Challenges about Development of New Processes in Refining and Petrochemistry

D. Decroocq

► **To cite this version:**

D. Decroocq. Major Scientific and Technical Challenges about Development of New Processes in Refining and Petrochemistry. *Revue de l'Institut Français du Pétrole*, 1997, 52 (5), pp.469-489. 10.2516/ogst:1997054 . hal-02079131

HAL Id: hal-02079131

<https://ifp.hal.science/hal-02079131>

Submitted on 25 Mar 2019

HAL is a multi-disciplinary open access archive for the deposit and dissemination of scientific research documents, whether they are published or not. The documents may come from teaching and research institutions in France or abroad, or from public or private research centers.

L'archive ouverte pluridisciplinaire **HAL**, est destinée au dépôt et à la diffusion de documents scientifiques de niveau recherche, publiés ou non, émanant des établissements d'enseignement et de recherche français ou étrangers, des laboratoires publics ou privés.



Distributed under a Creative Commons Attribution| 4.0 International License

MAJOR SCIENTIFIC AND TECHNICAL CHALLENGES ABOUT DEVELOPMENT OF NEW PROCESSES IN REFINING AND PETROCHEMISTRY*

D. DECROOQ

Institut français du pétrole¹

INTRODUCTION

The 1973 and 1979 crude oil crisis but also the Gulf War in 1991 deeply marked the international economic scene and the structure of energy markets. The tensions these events created in oil supplies and prices give rise to a more or less interrelated slowing down of economic growth, development of energy savings as well as a **widespread movement of substitution among primary sources of energy**. Consequently, the share of crude oil in the world energy consumption will drop from 50 percent in 1973 to around 30 percent in 2020 to the benefit of all other energy sources but mainly natural gas, nuclear power and to a lesser extent coal and hydroelectric power. Nevertheless, hydrocarbons will go on to play an important role in energy consumption by mankind because of their attractive physico-chemical properties, their easiness of use and the large capitalistic investments already granted for their valorization. Also **crude oil and natural gas** will remain the **leading energy sources**, accounting for about 50 percent of the world energy demand at the beginning of the twenty-first century.

Concerning the petroleum market evolution (Fig. 1), the greatest structural change stems from the refocusing of the uses of crude oil on specific markets—such as **transportation and petrochemicals**—whereas heating fuels (for house heating, power plants and industry energy needs) stand for a continually decreasing share in the crude oil balance sheet.

More precisely and about motor fuels, the long term gasoline market reflect the change in private car fleets, especially in european countries, an equipment ratio close to saturation and a decrease in specific consumption. Besides, the developement of gas oils relies essentially on the rapid progress in air or road transportation

(1) 1 et 4, avenue de Bois-Préau,
92852 Rueil-Malmaison Cedex - France

* Conférence prononcée au colloque scientifique de l'université de Gand, organisé en l'honneur du professeur Gilbert F. Froment, le 9 mars 1996.

and also on the move observed in some countries to diesel cars. As a result, oil will find outlets for 80 percent in 2020 against 50 percent in 1973 in non easily substitutable application fields.

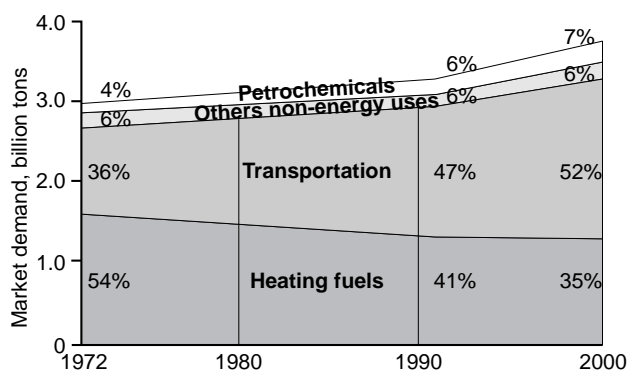

Figure 1
The changing worldwide oil market.

This drastic shift in the use of crude oil affect profoundly the demand breakdown according to the three major classes of petroleum cuts: light products such as gasolines and petrochemical feedstocks, middle distillates including diesel oil or house heating fuels and heavy products (Fig. 2). In fact, this distribution is increasingly turning toward light products and middle distillates at the expense of the heavy ones which have moved, during the last twenty years, from the first to the last place.

But increased emphasis on environmental problems, especially air pollution, will inevitably lead to more stringent regulations on emissions and refining has also to cope with the quality upgrading of petroleum products. Although the product specifications will not change in the same way everywhere, the objectives for the both gasoline and diesel oil will be rough the same: a reduction of their content in sulfur and aromatics compounds. For gasolines, in most industrialized countries, the octane specification must now be reached without lead so as to allow the generalization of catalytic mufflers. To comply with the lead phase-out and severe rising specifications, refiners are faced with the necessity of reformulating gasolines. In this field, the United States perform a pioneer work but other developed countries will probably adopt some similar regulations or harden some others of their own.

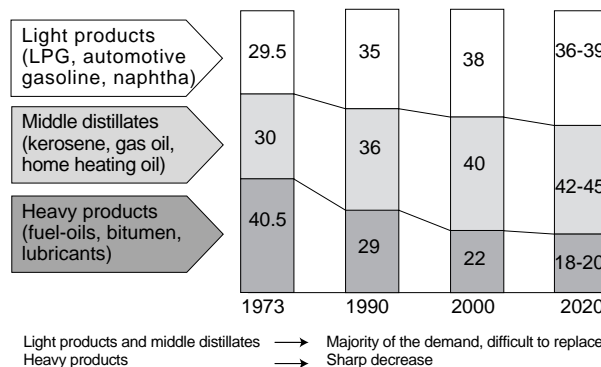

Figure 2
World demand for petroleum products (weight %).

Some characteristics of reformulated gasolines beyond the year 2000 are given in the Table 1. The most stringent specifications are for California with a maximal volume content of 1% for benzene, 25% for aromatics, 6% for olefins and 40 ppm for sulfur. So far, forecasts are less severe in Europe: limit for benzene and sulfur might decrease to 1 or 2 volume% and to 50 or 100 ppm respectively around the year 2000.

TABLE 1
Qualities of finished products – Future key constraints

	Possible evolution 2000-2020		
	Europe	North US area	California**
Premium gasoline			
RON (clear)	95 - 98		
ROM (clear)	85 - 88		
Benzene (vol%)	1 - 2	0.95	1
Aromatics (vol%)	20 - 30	24	25
Olefins (vol%)	5 - 10	9.2	6
Sulfur (ppm)	50 - 100	185	40
Oxygen (wt%)	2.1 < ox < L*	2.1	1.8 to 2.1
Diesel oil			
Sulfur (wt%)	0.02 - 0.05		
Cetane number	50 - 55		
Aromatics (vol%)	10 - 20		
Heavy fuel oil			
Sulfur (wt%)	0.5 - 1		
Nitrogen (wt%)	0.3 - 0.5		

* probable limit to be fixed (problem of driving comfort)
** applicable from march 1996

Limits for olefins could be mandatory beyond 2000 in countries which cope with ozone problems like in the USA. To meet the octane requirement, oxygenated compounds will be added with a lower limit of 2.1 weight% of oxygen. In Europe, oxygenated compounds will be almost solely ethers such as MTBE, ETBE and TAME.

In the USA again the situation is different, because the Environmental Protection Agency (EPA) recommends

that more than 30% of the oxygen must come from renewable sources (ethanol).

For **diesel fuel**, the swift tightening sulfur specifications (0.05 weight% this year in the European Union) is now the major constraint. However, more stringent regulations about reduction in aromatics (below 20 vol.% or even 10%) and increase in cetane number (up to 52 or 55) are already enforced in California and in strong debate elsewhere (Fig. 3).

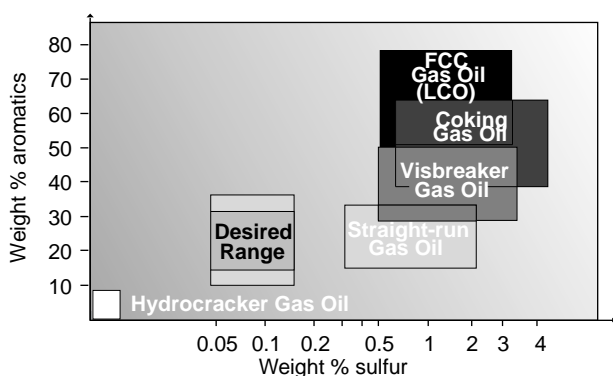

Figure 3
Aromatics and sulfur contents for gas oil.

Nevertheless the establishment of close and constructive relationship between the automobile and oil industries has become essential as a first step towards a new and more comprehensive strategy about the reduction of vehicle emissions. It is the main goal of the European Program on Emissions, Fuels and Engines technologies (EPEFE) driven by the *European Commission*.

These new market forces and environmental constraint regulations have led to major changes in the refining schemes which need now more flexible, adaptable and innovative processes. The Table 2 summarizes the main features of the past, current and future refining evolution through three steps. The first one, **simple refining scheme or hydroskimming**, relies on primary distillation unit (topping), cat reforming for improving the gasoline pool octane number and hydrodesulfurization of light and middle distillates; from classical crude oil the hydroskimming refinery produces more than 45 weight% of heavy fuels and is no more suitable to the present market.

Also the second one, using **conventional conversion units**, has rapidly become the most widely used scheme

accounting for more than two-third of the refineries currently in operation. It includes, besides the previously mentioned hydroskimming step, vacuum distillation, cat cracking and/or hydrocracking of the vacuum distillate, optionally associated to visbreaking, and reduces the heavy fuel oil production from 50 to 25 weight%.

Finally, under the double pressures of the fuel oil consumption decreasing and of the environmental requirements severization, newly developed processes, which need still significant technical advances, have to be integrated in the future refining scheme (third step) for **reformulation of gasolines** and to a lesser extent of diesel oil and **valorization of the bottom of the barrel**.

TABLE 2
Refining steps

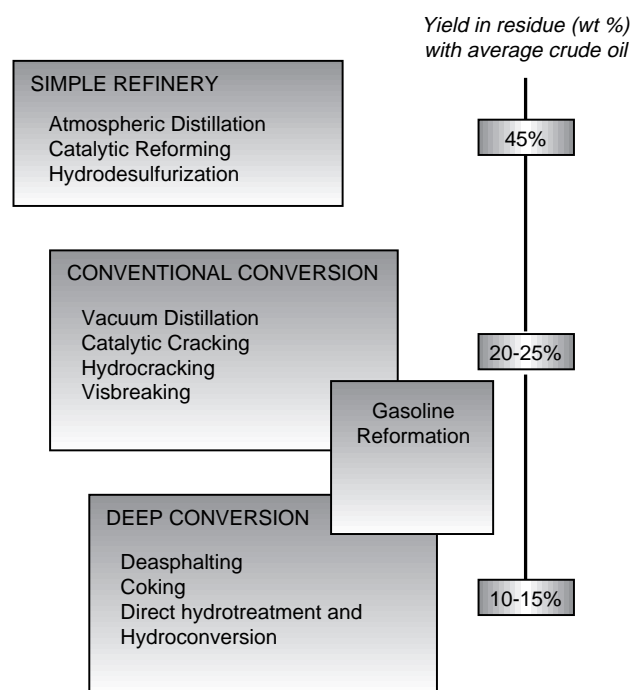

In spite of the impressive achievements over the last two decades, there is still room for key improvements and technological breakthroughs in the involved field. For illustrating this situation, I will review shortly in my lecture some of the most promising scientific and technical tools that R&D can use to reach this goal and some examples of their applications related to refining and petrochemistry processes.

1 SOME SCIENTIFIC AND TECHNICAL TOOLS

Refining and petrochemistry evolutions requires improvement of conventional processes but also development of new technologies. In this framework, heterogeneous catalysis, kinetic modeling of complex reaction networks, chemical reactors scaling up or down and validation of new reactor designs, new technologies dealing with the associated separation processes and optimal control strategies constitute some of the most important chemical engineering subjects involved.

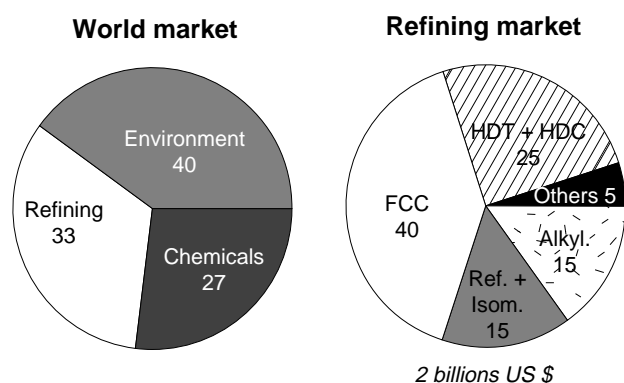

Figure 4
World catalyst market.

About **heterogeneous catalysts** which play a key role in many refining and chemical processes (Fig. 4), significant progresses can be expected from:

- **Development of new active solids** such as zeolites, layered compounds and mixed oxydes. From this point of view, acid catalysts or multifunctional catalysts including acid function hold an outstanding position and the Table 3 provides a review of their large field of applications.
- **Exploration of new routes** for modifying existing solids through recent ideas dealing with hydro-mineral synthesis or surface organometallic chemistry. For example, in zeolite type hydrocracking catalysts, secondary cracking is minimized by reducing the number of acid sites and the risk of overcracking practically disappears on modified zeolite.
- **Better insight into catalytic phenomena** with a precise description of active catalyst sites interacting

with the surrounding reaction medium. *In situ* surface characterization studies under reaction conditions, using for example infrared spectroscopy (via Fourier transform analysis), X-Ray diffraction (XRD) and X-Ray absorption spectroscopy (XANES and EXAF) methods should contribute to reach this objective.

TABLE 3
Acid catalysts in refining and petrochemistry

Processes	Catalysts	Temp. range °C	-H ₀
FCC	zeolite Y + matrix	500	8
Hydrocracking	SiO ₂ -Al ₂ O ₃ } + { Pd or zeolite Y } + { Ni MoS	380	8
Reforming	Slightly chlorinated Al ₂ O ₃ + (Pt-Me)	500	≥ 6
Isomerization C ₄ C ₅ -C ₆ C ₅ -C ₆	{ Highly chlorinated Al ₂ O ₃ } + Pt or AlCl ₃ /Al ₂ O ₃	200	14-17
		150	> 8
	H - mordenite + Pt	250	> 8
Olefin oligomerization	MFI	~ 300	> 8
Alkylation	SO ₄ H ₂ FH	≥ 5	} 11-12
		> 20	
Etherification	Sulfonated resins	50-80	3-4
LPG aromatization	MFI + Ga	500	> 8
Benzene alkylation	FH zeolite	< 50	11
		> 200	≥ 8
C ₈ arom. isomerization	Zeolite + Pt	~ 400	≥ 8
Arom. transalkylation	SiO ₂ -Al ₂ O ₃ zeolite	~ 500	8
		~ 400	≥ 8

In this connection, computational chemistry begin to succeed in modelling the structure of a catalyst and predicting some of its physicochemical properties. Density functional theory electronic structure computations have become the method of choice for studies involving transition-metals. Accurate electronic structure calculations cannot only be done on clusters but also on extended three dimensional systems or slabs, simulating the metal surface. Besides, in so far as classical two or three-body potentials are available, statistical mechanics methods as Monte Carlo techniques and molecular dynamics can be applied to predict the distribution of molecular adsorption sites, free energy of adsorption and diffusion constants.

For illustrating these methods, the Figure 5 shows, inside the supercage of zeolite-Y, the orientation of p-xylene on the principal adsorption sites located in

front of the sodium ions at specific positions S_{II} represented in the picture by the white spheres.

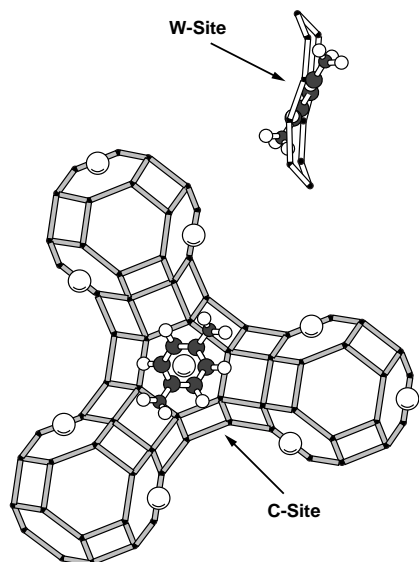

Figure 5
Adsorption of p-xylene inside the supercage of zeolite-Y.

About the residence times, the Figure 6 shows the translational motion of the center of mass of p-xylene along a single molecule trajectory of duration 2.2 ns; it can be seen that the molecule is strongly localized in front of the sodium ions at sites S_{II} ; moreover, the residence times at the adsorption sites are much longer than the timespans needed for the change of adsorption site.

Concerning **kinetic modeling**, the main objective is to build predictive model of catalyst activity, selectivity and stability and to provide knowledge based

models to take the place of the usual correlative approach. Now, the feedstock processed in petroleum refining or petrochemical operations consist of a large number of components, each of them reacting according to complicated pathways, and different methods of calculation can be implemented for this purpose.

In the first one, **based on molecular models and lumps**, the reaction network is frequently reduced to a limited number of reactions and lumps. The Table 4 shows the application of a molecular model using lumping method and Langmuir-Hinshelwood rate equations to the representation of the kinetic behavior of heavy gas oils (LCO) during their hydrotreatment.

TABLE 4
Modeling of gas oil hydrotreatment (HDS, HDN, HDA)

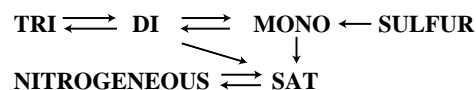

$$\begin{aligned} \frac{d[\text{MONO}]}{dt} &= \frac{k_2}{\theta_{\text{site}}^{-2}} [\text{DI}] - \frac{k_{-2} + k_3}{\theta_{\text{site}}^{-2}} [\text{MONO}] + \frac{k_s}{\theta_{\text{site}}^{-2}} [\text{S}] \\ \frac{d[\text{MONO}]}{dt} &= \frac{k_1}{\theta_{\text{site}}^{-2}} [\text{TRI}] - \frac{k_{-1} + k_2 + k_3}{\theta_{\text{site}}^{-2}} [\text{DI}] + \frac{k_{-2}}{\theta_{\text{site}}^{-2}} [\text{MONO}] \\ \frac{d[\text{TRI}]}{dt} &= \frac{k_1}{\theta_{\text{site}}^{-2}} [\text{TRI}] - \frac{k_{-1}}{\theta_{\text{site}}^{-2}} [\text{DI}] \\ \frac{d[\text{S}]}{dt} &= \frac{k_s}{\theta_{\text{site}}^{-2}} [\text{S}] & \frac{d[\text{NH}_3]}{dt} &= \frac{k_N}{\theta_{\text{site}}^{-2}} [\text{N}] \\ \frac{d[\text{N}]}{dt} &= \frac{k_N}{\theta_{\text{site}}^{-2}} [\text{N}] & \theta_{\text{site}}^{-2} &= (1 + \sum_i b_i [\text{C}_i])^2 \end{aligned}$$

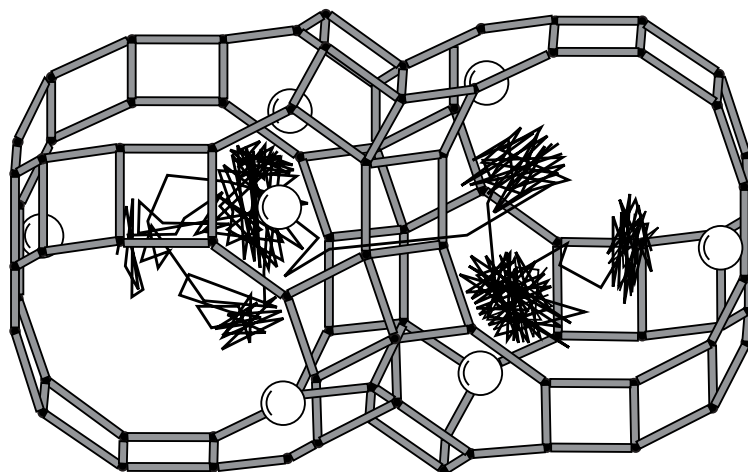

Figure 6
Translational motion of p-xylene inside the zeolite-Y network.

The model provides an accurate description of the tri-, di- and monoaromatics hydrocarbons evolution with the reaction time (Fig. 7) and describes also correctly the evolution of nitrogenous and sulfur-containing compounds. Nevertheless, excessive lumping may lead to parameters without physical significance, the empirical validity of which being only limited to the experimented feedstock.

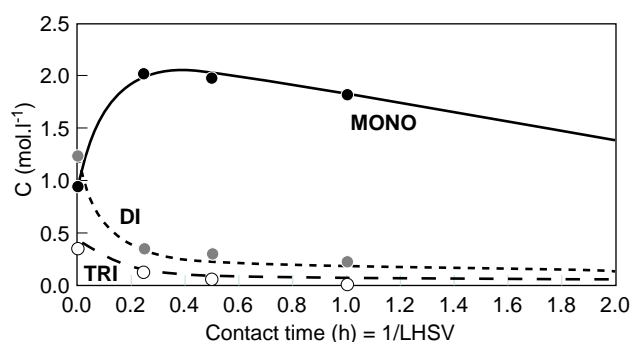

Figure 7
Molecular model validation for LCO hydrotreatment.

Also, another line of studies has been developed since the beginning of the 80's by Professor Gilbert Froment and co-workers in the *Laboratorium voor Petrochemische Techniek* in Ghent: in this more fundamental method the detailed mechanistic model of the various reactions originating from the feed components are retained to a maximum extent and the kinetics are developed in terms of **elementary steps and their single events**. This approach has been successfully used for modelling catalytic cracking, hydrocracking and hydroisomerization processes. The complete reaction network is generated by computer, using Boolean matrices as logical operators that describe the structure of the hydrocarbons and carbenium ions and accounting for each elementary step. Plausible assumptions and thermodynamics constraints limit the number of kinetic parameters. The true benefit of this approach becomes clear when complex mixtures are dealt with. In that case, the number of parameters hardly increases and, because of their fundamental chemical meaning, remain independent of the feedstock, whereas the lumping approach needs an increasing number of lumps and parameters to reach a sufficient degree of accuracy and to provide correct information on the product distribution. Indeed, in the single events method, chemical

analysis still requires a certain degree of lumping of components and reaction networks but not to the extent reflected by the pure lumping models.

Currently, theoretical background, development of new laboratory equipment (TAP reactor: temporal analysis of product; deactivation due to coke formation studies using TEOM microbalance: trapped element oscillating microbalance) analytical techniques (gas or liquid chromatography coupled with mass spectroscopy) and computers power boost vigorous progress in the kinetic modelling of complex processes but the following lecture delivered by the Dr J. Katzer (*Mobil*) will lay stress on the main outstanding advances in this field.

Reactors scaling up and design requires also general methods for studying and analyzing complex systems involving, in addition to the catalysis and chemical kinetics aspects, hydrodynamic phenomena but also mass and heat transfer problems at the meso (catalyst pellet) scale and at the macro (catalyst bed) scale. Moreover flow of granular solids have to be investigated more deeply as moving beds, fluidized beds or ebullating beds take duty for the fixed beds processes, so as to fight against more rapid catalyst deactivation due to more severe operating conditions. On the **experimental side, pilot plants** including sophisticated measurement devices play always a major role in the development scheme of conversion processes. Nevertheless, for going from the pilot plant stage to the industrial unit without major problems, the experiment carried out in the development work have to be plan for scaling up purpose. In particular, this fact implies that the choice of the industrial technology must be made at the outset and that the pilot reactor accordingly be designed to simulate the industrial reactor. In other words **the real problem often lies in scaling down rather than in scaling up. Mock-ups or cold flow models** help to analyse separately the physical phenomena which are more sensitive to size such as flow of fluids or solids: the choice, in this case, of soft operating conditions and of harmless fluids with physical properties approaching these of the reaction mixture make easier experimentation and data analysis. The Figure 8 shows a 80 t/h cold flow circulating fluidized bed where most of the important features of fluid cat cracking can be found (a 300 mm internal diameter riser, a 12 square metres catalyst cooler, withdrawal wells, standpipes and a 1500 mm internal diameter fluidized bed). A scale one/one feed nozzle and a recent 2 barrels

per day hot pilot unit for studying the coupling between physical and chemical phenomena make up the tools large scale facilities now available in the *IFP Development Center of Solaize* in order to improve residues cat cracking scaling-up and performances.

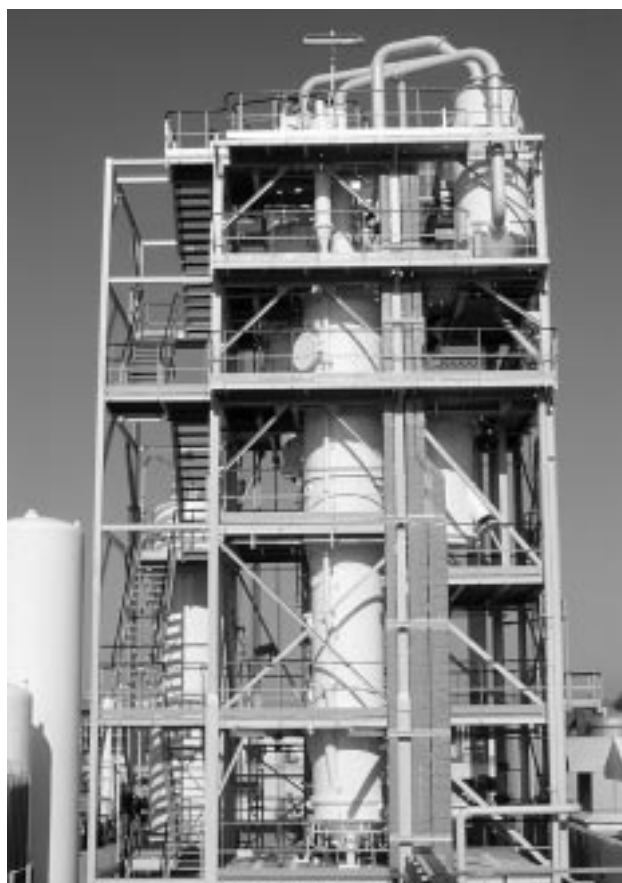

Figure 8
Cold flow unit applied to the study of the catalytic cracking processes.

About local data acquisition, a great deal of measurement methods are now able to give accurate values, through appropriate sensors, of temperature, pressure, velocities, concentrations of chemical species, phases ratio (gamma-Ray tomography), size of bubbles, drops or particules as well as to produce a global visualization of flows. For example laser-based measurements (laser-doppler anemometry, laser induced fluorescence spectroscopy) are quite powerful and can supply swiftly a large number of data without perturbing the behaviour of the system under study.

On the **theoretical side** now, computational fluids dynamics deserves certainly consideration as a potentially useful and efficient tool for simulating multiphase

systems (gas-liquid, gas-solid) flow in which case scaling-up meet still great difficulties and relies on empirical procedures based on very simplified models. In the moving catalyst beds, the analysis of the solid particules movement is a very challenging problem; then, conventional computational fluid dynamics equations will not be sufficient and physical laws related to soil dynamics should be considered; for fluidized beds there is still basic knowledge missing about the physical behaviour of the gas-solid system, especially concerning the coalescence of bubbles and the momentum transfer between gas and solid. Also, for applying this new approach to the simulation of reactive flows in catalytic reactors, a challenge already taken up in combustion processes, many difficulties have still to be solved due to the complexity of the phenomena involved: fluid dynamics, chemical reactions and physico-chemical aspects. Another complementary difficulties come from the numerical treatment of the final model equations resulting in very sophisticated and diversified applied mathematic methods. Therefore, it seems essential for the success of any work in the field to achieve a truly cooperative and interactive team-work including specialists in fluid dynamics, chemical engineering, physics, physical-chemistry and applied mathematics.

Concerning the associated **separation and purification** technologies three points are worth to be note:

- The development of the **catalytic or reactive distillation** which unites in the same equipment catalyst and distillation devices finds its main applications for reversible reactions, such as MTBE or ETBE synthesis, so as to shift an unfavorable equilibrium by continuous reaction product withdrawal. But catalytic distillation can provide also several advantages in selective hydrogenation of C_3 , C_4 and C_5 cuts for petrochemistry. According to the CDTECH claims, putting the catalyst in the fractionation column improve mercaptans removal, catalyst fouling resistance and selective hydrogenation performances by modifying the reaction mixture composition along the column.
- **Adsorption** is expected to increase in importance partly because of its obvious application in the environmental area. New progresses in adsorbents (zeolites with appropriate polarity and geometry) and regeneration configurations (based for example on the simulated countercurrent applied to the p-xylene purification) (Fig. 9) will fuel this trend. But predicting process performances from adsorbent

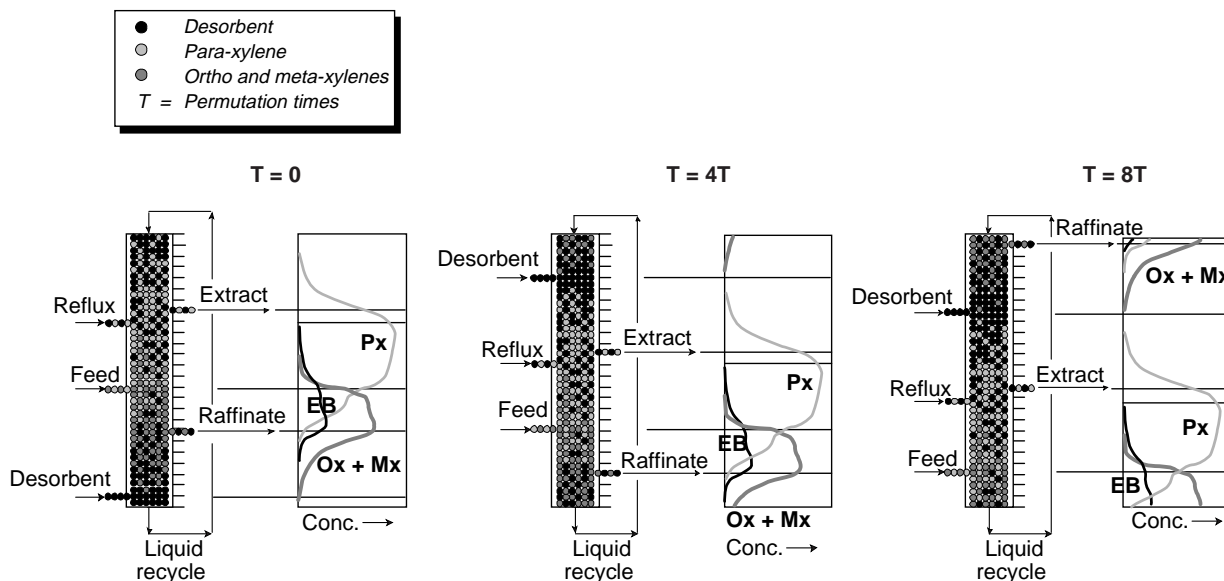

Figure 9
Principle of simulated countercurrent adsorption.

characteristics, system properties and operating conditions however should remain a stimulating research challenge.

- Advances in both polymer (polyimides) and inorganic (carbon) membranes are opening new applications to membrane processes. Improving arrangement of the asymmetric hollow fibers to conceive new modules liable to work in more efficient operating conditions (higher pressure, transverse flow) should contribute to expand their uses mainly in the field of gas purification. The weakness of this technology includes still fouling and the lack of durability of membranes materials. Additionally, capital cost for membrane unit often are too high to compete, in refining and petrochemistry, with other separation processes. Nevertheless, recovering of hydrogen from hydrocarbon gas streams present at low pressure could offer good opportunities of application to the membrane processes.

About **new equipments** key forward steps deserves specific mention in areas such as heat transfer (high efficiency plate type exchangers for cat reforming Packinox), distillation (where the structured packing used to better the efficiency of the vapor-liquid contact constitute an example of application for the honey comb type monoliths), valves for high temperature, high pressure multiphase systems and so on (Table 5).

TABLE 5

Equipment development

- Heat transfer equipment: Packinox type
- Advanced separation systems: Membranes
- Mixing systems
- Valving systems

Finally, in the field of **process control**, plant automation, on-line optimization and strategies of control are all part of the advanced technical movement. New optimization systems lead to capacity and efficiency increases, quality improvement, enhanced safety, better operating and process information.

Playing a central role in the computerization of the refinery is the newly improved technology of **process simulation**. In the advanced control system of the future, mathematical models, equation-based systems and optimization will be routine in control loops. The biggest change will involve the extensive **use of data bases** and artificial intelligence to come to operating decisions.

But let us back now to the long term refinery configuration depicted in the Table 6. I would illustrate

TABLE 6

Long term refinery configuration (2010-2020)

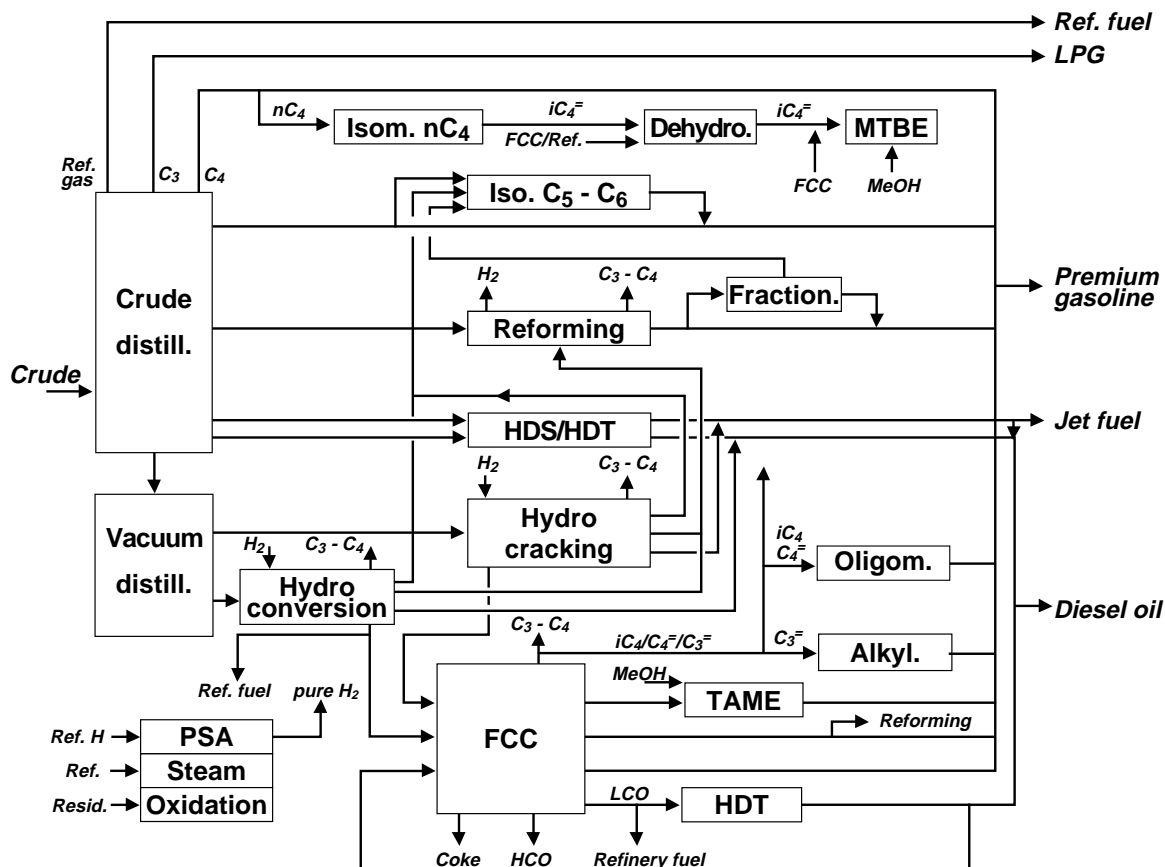

through some refining and petrochemistry processes the scientific and technical advances above mentioned.

To do that we will discuss successively about:

- the new gasolines refining and reformulation through catalytic reforming, isomerization and alkylation;
- the deep conversion and the valorization of residues (by hydrotreatment and catalytic cracking);
- the manufacturing of insaturated hydrocarbons for petrochemistry.

2 NEW GASOLINES REFINING AND REFORMULATION

The Figure 10 sums up the chemical problems set to the refiner for manufacturing bases with high octane number. The graph displays the research octane number (RON) of various families of hydrocarbons versus their carbon atoms number; the dotted line marks the octane level reached by a premium gasoline. Linear paraffines (or alkanes) and naphthenes (or cycloalkanes) which are

the main components of straight-run gasolines have low octane numbers and are thence unsuited to produce commercial gasolines.

In this prospect, the best hydrocarbon families are the alkylbenzenes (or aromatics), the branched alkanes and, in some degree, olefins. At the same carbon atoms number, deshydrocyclization of alkanes or deshydrogenation of cycloalkanes into aromatics compounds through the catalytic reforming process of the C_7 - C_9 straight-run gasolines but also isomerization of linear into branched alkanes through the isomerization process of C_5 - C_6 cut provide gasoline bases with an outstanding research octane number increase. With reduction of the carbon atoms number, corresponding to a diagonal moving in the graph, heavier saturated hydrocarbons are transformed into lighter alkanes and olefins through the cat cracking process and its satellite units which produce other some good-quality blends (oligomerization, alkylation and also etherification for manufacturing oxygenated compounds).

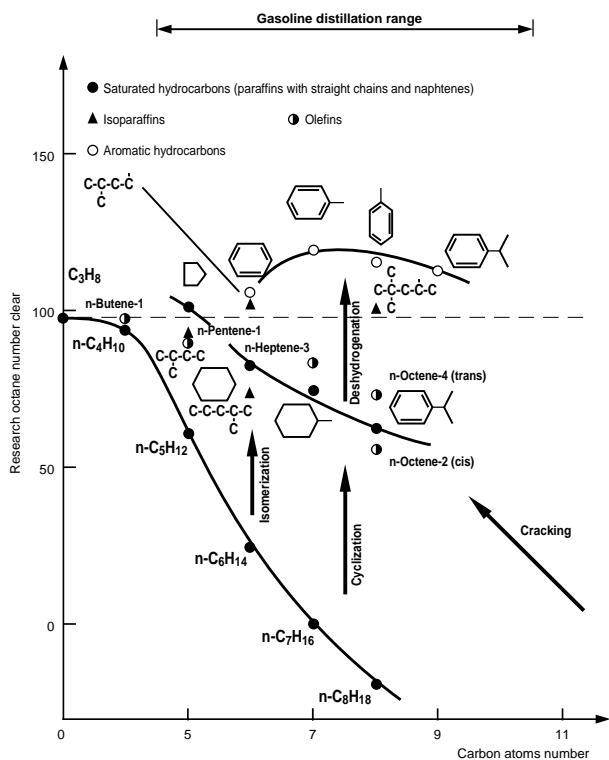

Figure 10
Research octane number of various families of hydrocarbons.

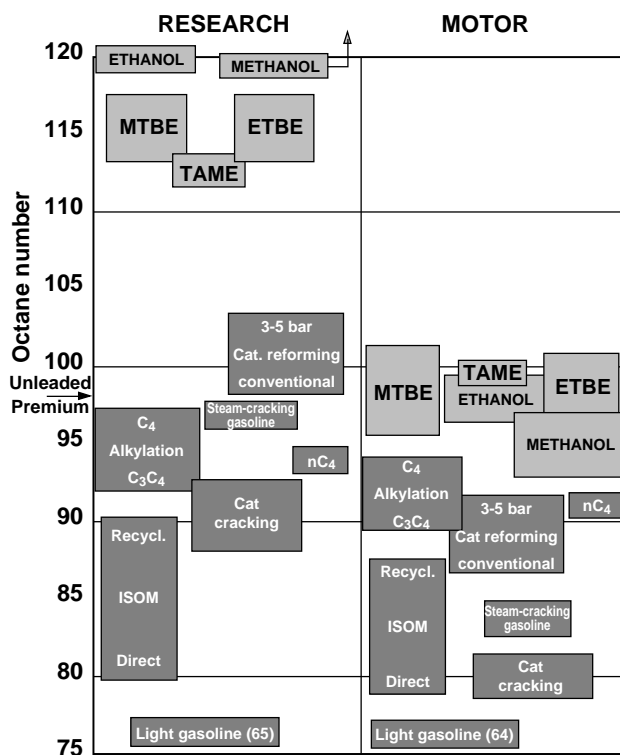

Figure 11
Octane properties of bases for gasoline pool.

The Figure 11 shows (on the left) the research octane number of the gasolines bases supplied by cat reforming, isomerization, (fluid) catalytic cracking, alkylation and etherification; the right side of the figure is devoted to the motor octane number (MOR) of the same bases which approximate better the road behavior of spark-ignition motors than the conventional research octane number. The most environmentally friendly gasolines comes from highly branched paraffins and perhaps ethers in spite of the fact their combustion seems to entail some drawbacks such as aldehydes emission mainly during start-up. Nevertheless, aromatics and olefins will remain necessary as component of the gasoline pool even though their share should be reduced in the next future.

Some words now about catalytic reforming and isomerization of straight-run gasolines. Although, two decades ago, several economists predicted the abrupt fall in demand for this process, catalytic reforming remains today a key element in any refinery not only for gasoline production but also as a major hydrogen source for hydrotreatments and aromatics source for petrochemistry. The evolution of catalytic reforming

have been very impressive in response to successive challenges: an increase in the field of the C_5^+ reformate reaching very high octane level (from 100 to 105), a recently maximizing hydrogen production while maintaining high octane levels and controlling the aromatics content. The chemical reactions involved in cat reforming (Fig. 12) constitute a complex network and require a bifonctionnal catalyst with metal and acid functions. Also by the side of the main deshydrocyclization reaction transforming alkanes and cycloalkanes into aromatics appear secondary reactions: at high hydrogen pressure, hydrocracking limits the gasoline and hydrogen yields; but at low hydrogen pressure, hydrogenolysis and above all coke formation entail a rapid catalyst deactivation. Consequently, for cat reforming, evolution of catalyst, technology and operating conditions are three complementary and interactive driving forces of progress.

About **catalysts** (Fig. 13), bimetallic then multi-metallic formulations, joining to platinum various metals such as germanium, tin, rhenium and irridium marks outstanding milestones and have opened up the way towards more selective and stable catalysts, with

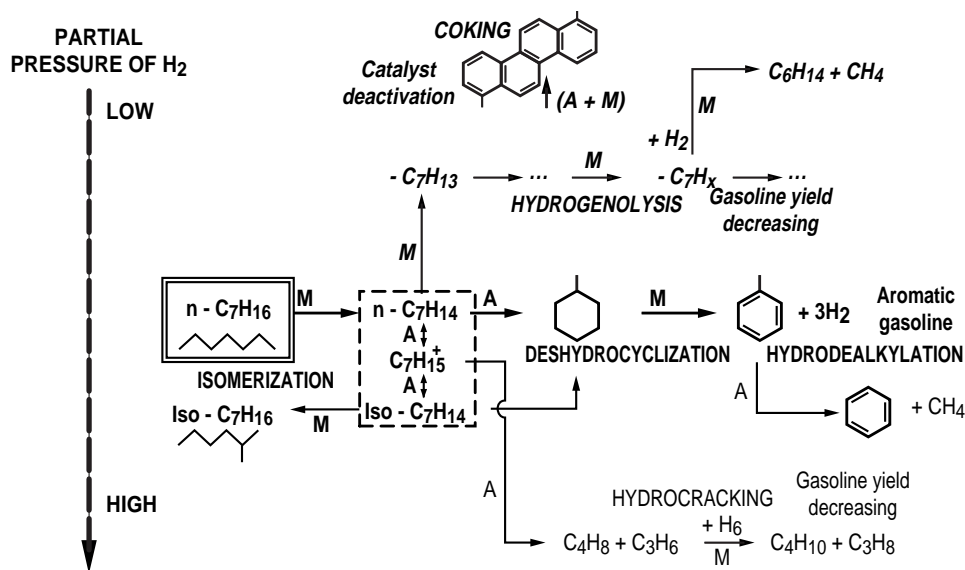

Figure 12
Cat reforming: reaction network.

limited hydrogenolysis, hydrocracking and dealkylation activities, which are able to work at very low pressure so as to improve especially the hydrogen yield and to limit the benzene content of reformate.

Concerning the **reactors technology**, the continuing development of the cat reforming process is illustrated by the gradual reduction of the operating hydrogen partial pressure due to the sharp decreasing of the reactor pressure and of the molar hydrogen/hydrocarbon recycle ratio (Fig. 14).

From an initial pressure of 25 bars and a hydrogen/hydrocarbon ratio of 6 on monometallic catalysts working in fixed bed (semi-regenerative units), multi-metallic catalysts, moving bed technology and

continuous regeneration have allowed to reduce currently these figures to 3 bars for the operating pressure and 2 for the recycle ratio. Low pressure operation calls for continuous regeneration of the catalyst with an ever increasing pace as pressure decreases (from 15 days to 3 days now). In continuous catalyst circulation and regeneration system (Fig. 15) the catalyst flows from the regenerator and is reduced just prior to get into the first reactor. In each of the three or four reactors, the catalyst bed is moving slowly downwards while it is radially crossed by a flow of gas at 500°C. A lift pot system allows for transport of catalyst and hydrogen gas is used as lift media for catalyst transfer between reactors. About transfers to and from the continuous regenerator, nitrogen is employed. Catalyst is removed

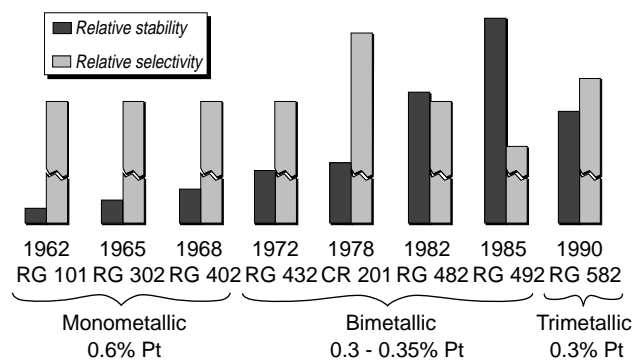

Figure 13
Evolution of the stability and selectivity of reforming catalyst.

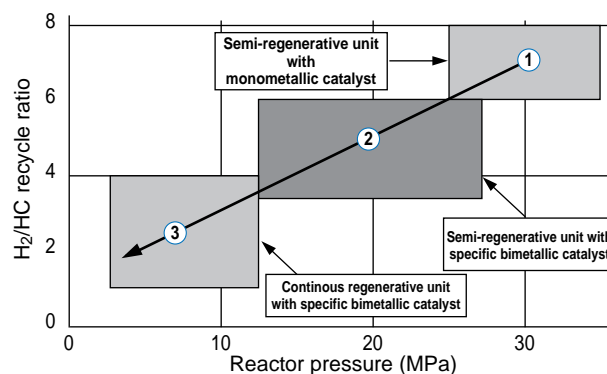

Figure 14
Evolution of operating conditions for cat reforming process.

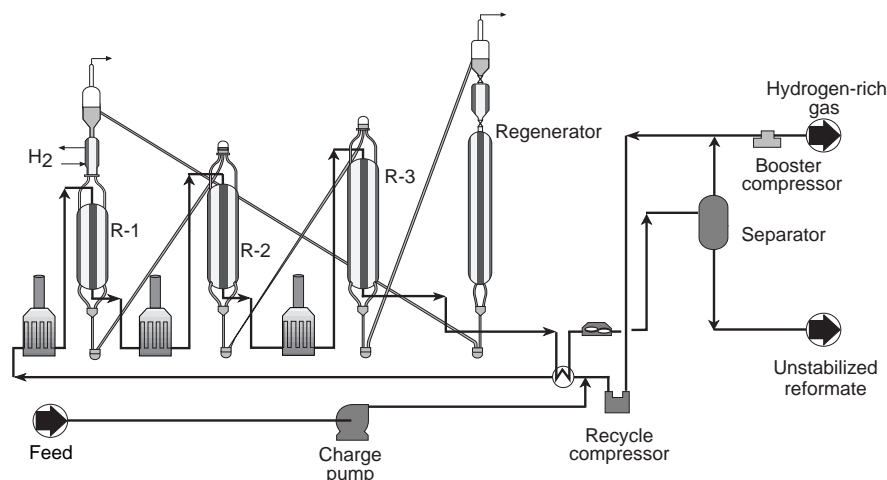

Figure 15
Continuous catalytic reforming
(oxtanizing process).

from reactors and transported by the use of the lift, any valve being set up on the solids transport section.

The major drawback of the cross flow gas moving bed contactor operation is the "**pinning effect**". At a given value of the gas flow rate and of the pressure drop through the bed, the solid flow is stopped due to the action of the drag force of the interstitial gas on the catalyst pellets. Hence, the prediction of the pinning occurrence is essential to ameliorate the contactor

operation. Usually, the pinning effect is analyzed by using experiments on scale models representing the process. Recently, a numerical modelling of the mechanics of the catalyst flow in an annular container, interacting with a cross gas flow in the central part of the wall container, has been performed by using the finite element method. The results plotted in the first diagram of the Figure 16 show the gas pressure field which clearly indicates a radial gas flow. In this graph, three different

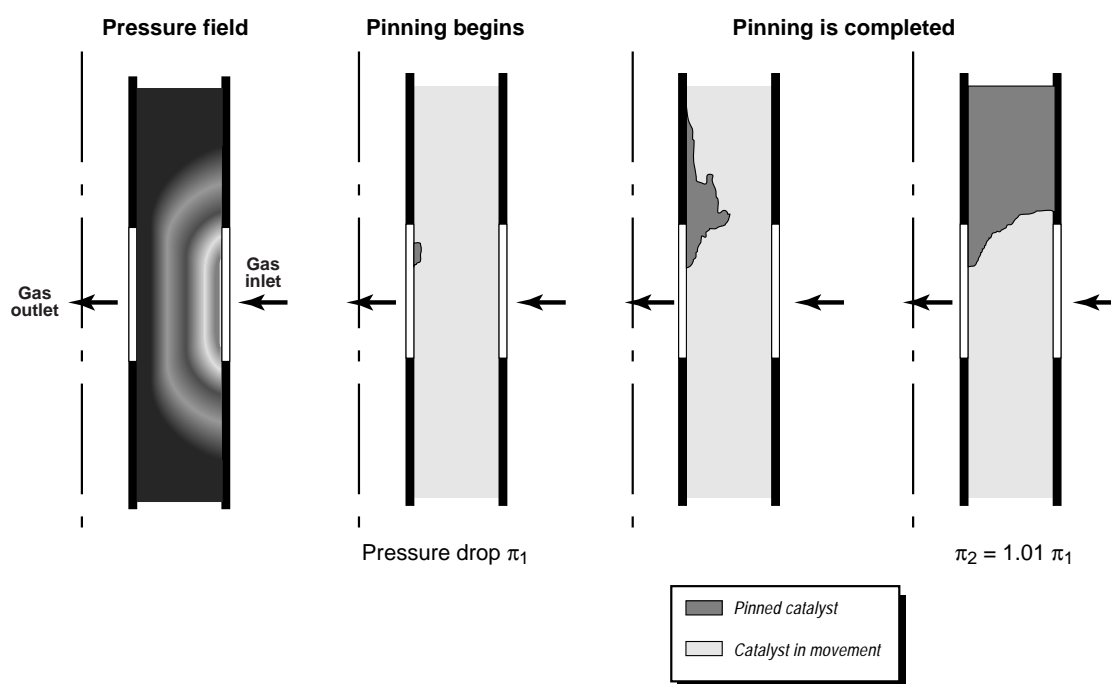

Figure 16
Numerical modeling of the pinning effect.

states of the catalyst bed during the gas injection are also shown. The start of pinning was obtained at the top of the gas outlet screen. In this calculation, the gas inflow rate was increased up to the complete pinning of the bed. In conjunction with experiments, these numerical methods are developing rapidly and they will certainly be greatly operated in the future for the design of reforming catalytic reactors.

But the manufacturing of non leaded gasolines require also, for raising the research octane number of the gasoline pool to convenient values without excess content of aromatics, the industrial implementation of processes treating or producing high branched paraffins (isomerization and alkylation) and the use of oxygenated products as octane boosters (MTBE, ETBE) which have good research and motor octane numbers.

According to this concern, C₅-C₆ hydroisomerization process appears as one of the least costly methods available. The C₅-C₆ normal paraffins are concentrated in the straight-run light gasoline characterized by a moderate research octane number around 70 but generally excluded from cat reforming due to their lack of reactivity. In conventional simple one-through C₅-C₆ isomerization process, reliance is placed on platinum impregnated zeolite or more active chlorinated alumina catalysts in the presence of hydrogen to convert any C₅-C₆ feedstock into a mixture of normal and branched paraffins at their thermodynamic equilibrium. This one-through isomerization scheme is of course limited in its performances with an octane increase of 13 points. In order to get higher octane values, the recycling of all normal paraffins is needed. The operation involves the

separation and recovery of the normal paraffins from their branched isomers and then the recycling of the recovered normal paraffins to the reactor. Molecular sieve technology, either in vapour or in liquid phase, selectively adsorbs normal paraffines because of their smaller molecular diameter and excludes the larger diameter branched molecules. The adsorption step is followed by a desorption one for a net recovery of the normal paraffines. The Figure 17 shows a flow-sheet of an isomerization process (IPSORB) combining reaction and molecular sieves sections and using isopentane vapor to desorb the normal paraffins from the adsorbent by pressure swing device. With this technology using chlorinated alumina catalyst, a research octane number as high as 90 can be reached, that is to say an octane gain from 20 to 22 points (Table 7).

TABLE 7

Light gasoline isomerization performances

Phase	Description	Isomerate RON	
		Chlorinated alumina	Zeolite
1	Once-through isomerization	83	80
2	Add deisopentimizer	84	82
3	Convert to Ipsorb	90	88
4	Convert to Hexorb	92	90

Moreover important progresses may be expected from more active zeolites catalysts, working at lower temperatures in thermodynamic conditions where

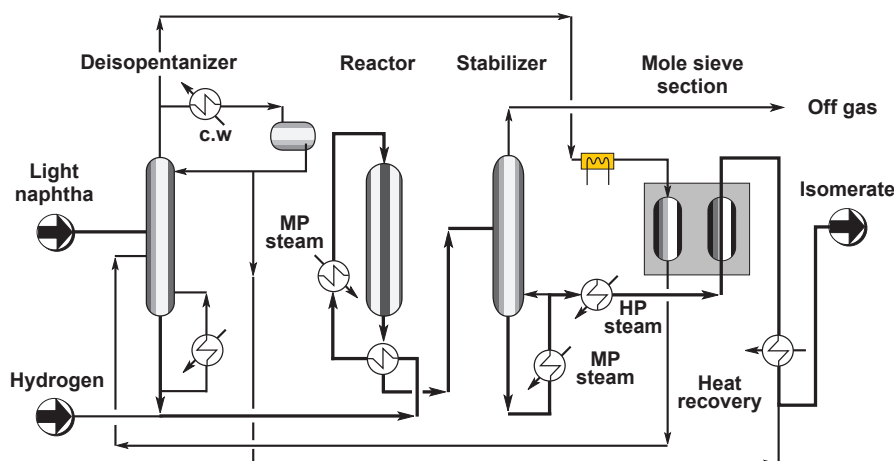

Figure 17
C₅-C₆ isomerization: basic Ipsorb process.

formation of branched paraffins is encouraged. Important research challenge lies also in the isomerization of C₇ and C₈ paraffins which is not economically feasible today due to low yields.

Alkylation of light olefines, produced by the catalytic cracking unit, with **isobutane** is the reaction which yields the most wanted compounds, branched hydrocarbon with mainly C₅ to C₁₀ carbon atoms. The two major alkylation technologies, using acid catalyst in liquid phase, are both well established processes with extensive application in the worldwide refining industry. However a major drawback lies in the potential environmental and safety hazards of these technologies due to the use of large volumes of liquid phase catalysts, either sulfuric acid or hydrofluoric acid. Most of the safety and environmental concerns are related to the potential for a large release of these liquid acids, especially hydrofluoric acid.

A solid acid catalyst would potentially overcome most of the drawbacks associated with liquid acid catalyst systems and open up a new area of marketing for alkylation. Numerous companies are putting a large R&D effort in the development of new solid catalysts for the alkylation process (Table 8).

TABLE 8

New alkylation replacement processes

Compagny	Catalyst	Technology
Topsoe	CF ₃ SO ₃ H/SiO ₂	Fixed bed
Catalytica-Neste-Conoco	BF ₃ /Al ₂ O ₃	Grignard
Chevron-CRL	SbF ₅ /SiO ₂	Circulating bed +washing
Shell	Zeolite H-b	Grignard

At the present time, these catalyst systems still experience problems with rather rapid catalyst deactivation which would lead to a complex reactor system to provide necessary frequent catalyst regeneration. However and although none of these new processes have been installed at commercial stage, several pilot units are operating and progress goes on steadily. Short of changing the catalyst altogether, handful of companies are working toward developing simple additives that reduce the tendency of hydrofluoric acid to form mists. Besides, on site sulfuric acid regeneration is available

to eliminate shipments of spent and regenerated acids but is not extensively used.

3 DEEP CONVERSION AND VALORIZATION OF RESIDUES

As we have introduced the fact at the beginning of this lecture, the next century will be marked by the necessity of producing much less or even no heavy fuel oils. In that prospect, refining will have to be fully equipped with deep conversion capacity.

Nevertheless residues are hard feedstock according to their high content of very complex compounds so called resins and asphaltenes. Their chemical structure characterized by an high C/H atomic ratio is especially rich in heteroatoms mainly sulfur, nitrogen and metals contaminants (nickel and vanadium).

The **residue conversion processes** are either based on **carbon rejection**, such as coking and deasphalting, or on **hydrogen addition**, such as catalytic hydro-treating. To minimize fuel oil and coke production, several processes combination using two or three processing steps can be implemented in the refining scheme. The first step typically uses catalytic hydrometallization, hydrodesulfurization and leads to partial conversion. The final conversion step can be coking (delayed or fluid), resid fluid catalytic cracking or a gasifier (*Texaco, Shell*) with the later two approaches yielding no heavy ends.

Generally speaking such technologies are very costly and requires severe operating conditions, large size units and high hydrogen and catalyst consumptions.

Whatever the kind of solutions, the hydrogen requirement depends basically on the level of conversion. Catalytic reforming will not be able to cover such a demand even with improved catalyst and specific hydrogen production units will have to be built (steam reformers or partial oxydation) entailing a strong increasing of investment and operating costs.

In this connection, we will focus only upon the residue hydrotreatment followed by the fluid catalytic cracking of the hydrotreated residue.

The first step combines hydrometallization, hydro-sulfurization and partial conversion (from 30 to 50 weight%) of resins and asphaltenes in a severe hydrotreatment of the 550°C+ residue to achieve more valuable products, to improve their quality (less sulfur, nitrogen, metals and carbonaceous residues) and thus

allows them to be subsequently treated in a conversion unit such as a resid cat cracking. But efficient residue hydrotreatment requires development of new catalysts, launching of new technologies or up-dating of former ones. About catalysts, the deleterious effect of metallic contaminants are well known and many efforts have been made to develop catalyst which can tolerate a high concentration of metals without too serious loss of catalyst activity and life. The problem may be partly solved by the association of appropriate HDM and HDT catalysts which contribute to increase strongly the performances of new processes for residues refining such as the Hyvahl technology.

The purpose of the demetallization catalyst is to remove the majority of the metals contained in the feed. Therefore, the catalyst must be able of preferentially converting the resins and asphaltenes in which most of these metals are found and also must have a great retention capacity facing metal deposits. For classical microporous hydrotreatment catalysts, the study of the metal deposits profile, at the scale of the catalyst bed, reveals that deposits are restricted to the outer shell entailing mouth pores plugging (Fig. 18).

On the other hand, the catalysts with a polymodal breakdown of porosity used for hydrodemetallization have a porous structure which is particularly well suited for achieving high activity and avoiding diffusion and plugging problems. Preparation of the support is carried out in such a way as to produce a microcrystalline form

resulting in "chesnut-bur" like pores and a very non acid material. Consequently, this catalyst has a large pore volume and an appropriate pore distribution which allow the diffusion of resins and asphaltenes into the catalyst pellet and their adsorption on the active sites. In this range of porosity, the catalyst works better for vanadium, nickel and asphaltenes elimination than for hydrodesulfurization (Fig. 19).

The catalysts so designed present an uniform deposit of metals throughout the pellet preventing plugging up of the pore network and a high metal retention up to 100 percent when compared to the weight of fresh catalyst. The very high metal capacity also depends on the intrinsic activity provided by the active phase (Ni and Mo sulfides) on the optimized support. If this activity is too high, there is a risk of a less homogeneous distribution of metals deposited on the pellet and hence of a less retention. On the other hand, high hydrogenation activity reduces carbon deposits on the catalyst and improved demetallization activity.

The HDT catalyst, as for it, has the main function of desulfurization of the already deeply transformed feed. The support choosen for this catalyst has a porous texture which is especially suited for these reactions. Several square metres of mesoporosity still enable heavy fractions to go on to react while most of the surface area is created by pores having a diametre between 80 and 120 Å. This surface area is highly accessible for the lighter fractions of the feedstock but

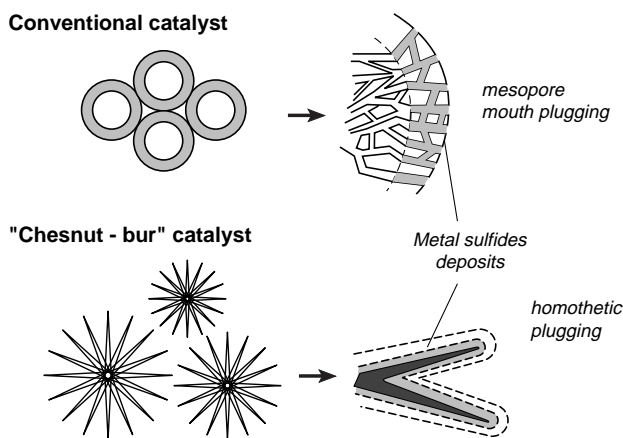

Figure 18
Hydrodemetallization (HDM) catalysts.

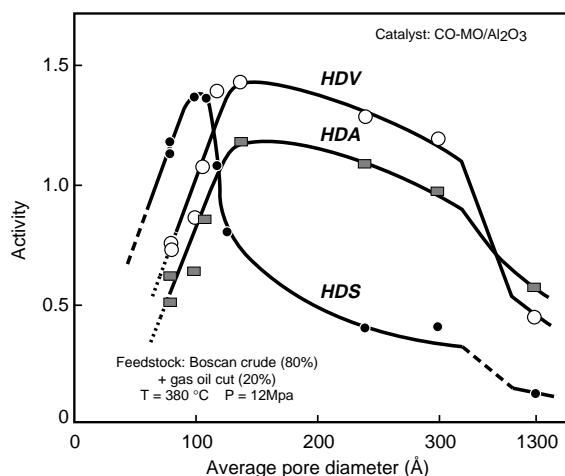

Figure 19
Relationship between catalyst porosity and relative activity in hydrotreatment (HDT).

much less for residual asphaltenes. Also this catalyst has a greater HDS function than HDM and hence focuses upon desulfurization and denitrication (Fig. 19).

Concerning **technology**, various kind of processes aim to cope with the catalyst deactivation and to handle residues as economically as possible (Table 9): continuous replacement of catalyst (OCR/*Chevron*), swing reactor concept (Hyvahl/*IFP*), bunker type reactor (Hycon/*Shell*), ebullated bed technology (H-oil/*HRI*, LC-Fining/*Lummus*) and slurry type system.

TABLE 9
Residue hydroconversion

• Continuous catalyst replacement	OCR/ <i>Chevron</i>
• Swing reactor concept	Hyvahl/ <i>IFP</i>
• Bunker-type reactor	Hycon/ <i>Shell</i>
• Ebullated bed	H-Oil/ <i>HRI</i> LC-Fining/ <i>Lummus</i>
• Slurry system	Microcat/ <i>Exxon</i> Veba Combi-Cracking/ <i>Veba</i> HDH/ <i>Intevep</i>

The Figure 20 provides a view of the new pilot plant recently erected in Solaize and including two ebullating beds reactors of 3 cm of diameter and 3.7 meters of height; at their outlet the conversion of the vacuum residue reaches 60 to 70 weight%. The stirring up of the feedstock and catalyst mixture is carried out by recycling of gas and non converted vacuum residue. The pilot plant simulate the performances of industrial H-oil unit and should offer good opportunities for improving their level.

The **fluid catalytic cracking process** (Fig. 21) uses finely sized power catalyst which continuously circulates in a closed loop between the reactor system and the regenerator system. The reactor system provides proper feed-catalyst contacting time and temperature profile to achieve the desired level of conversion. It also desengages the reaction products quickly from the spent catalyst. The regeneration system, as for it, restores the catalytic activity of the coke-loaded spent catalyst by combustion with air. Most of the heat released from coke combustion is adsorbed and heats up the catalyst before its recycling toward the reactor.

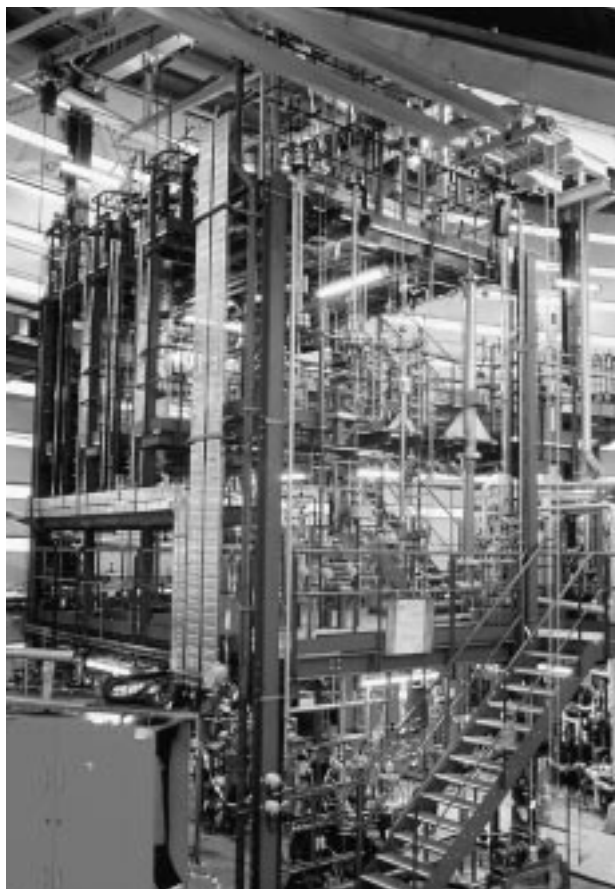

Figure 20

HRI pilot plant of ebullating beds erected in the IFP R&D Center of Solaize.

In the field of fluid catalytic cracking now, a major trend is to replace the conventional vacuum gasoil feedstock by heavier materials either a mixture of vacuum gas oil with residue or/and hydrotreated residue (RFCC unit).

Hydrotreated residues can be directly converted after in a resid fluid catalytic cracking so long as the carbon conradson index is lower than 6 to 8 weight% and the total metal content is less than 20 ppm. Nevertheless, the use of heavier, more contaminated feedstocks conduces to increase the production by fluid catalytic cracking of coke and to deactivate the catalyst. Thus, to be successfully upgraded by fluid catalytic cracking, resid feedstock require special technical innovations. Among them, major emphasis can be placed on:

- the two stages catalyst regeneration by burning coke deposits associated to a catalyst cooler so as to master the heat release due to coke combustion (Fig. 21);

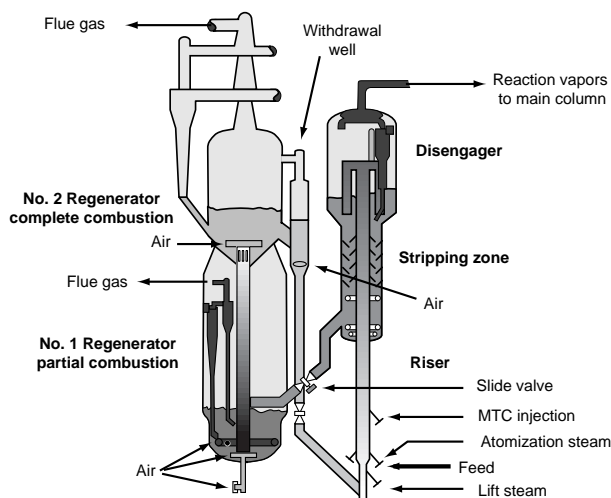

Figure 21
RFCC unit. Reactor and generator.

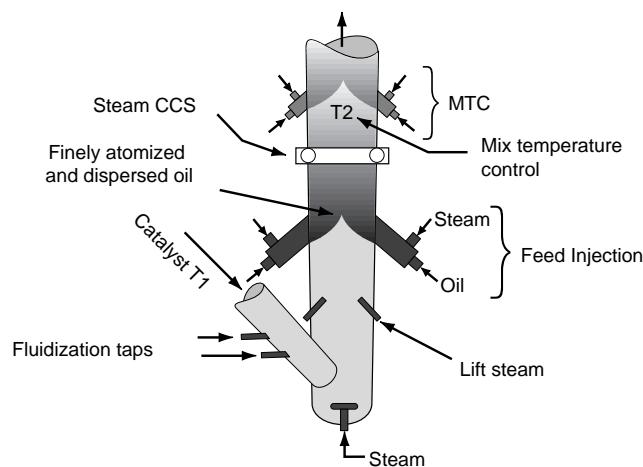

Figure 22
Feed injection and catalyst contacting system.

- advanced feed injection system in the riser reactor using improved spray nozzles to ensure rapid and homogeneous feed vaporization (Fig. 22). Moreover, injection of feed at countercurrent of the catalyst circulation seems to improve the riser reactor performances;
- new cyclone systems (ramshorn separator) to minimize catalyst carry over and reduce the hydrocarbon residence time in the reactor dilute phase;
- increase of the stripping efficiency by development of new internal devices able to enhance the desorption of hydrocarbons from the coked catalyst by breaking up bubbles and favoring catalyst downwards plug flow;
- temperature adjustment in the riser by injection of a recycle stream above the zone of the fresh feed injection.

Moreover, in the 80's, *IFP* investigated widely the riser hydrodynamics using gamma-Ray scanning and momentum probes on the large cold flow presented previously for the study of the fluidized beds (Fig. 8).

In the 90's, a lot of efforts have been made to investigate downflow hydrodynamics thanks to a specially designed circulating fluidized bed loop with optic-fiber probes, capacitance sensors and sampling probes.

The Figure 23 provides a scheme of this loop: the downflow reactor has a 5 cm internal diameter and gas velocity can reach 10 m/s with cat circulation of 125 kg/s/m². The comparison upflow/downflow clearly shows that the flow is much more homogeneous in

downflow reactors than in upflow reactors. Thus, the Figure 24 shows the reduced catalyst concentration (ratio of the local catalyst concentration over the cross-sectionally average concentration) at the end of the reactor for upflow and downflow.

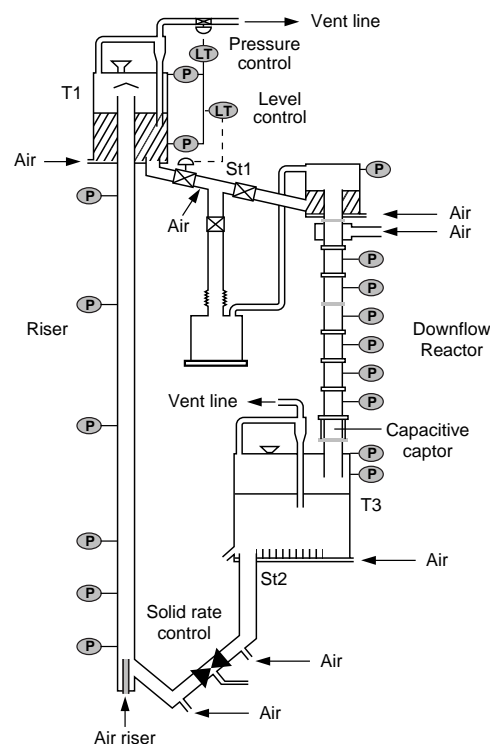

Figure 23
Circulating fluidized bed cold mock up for investigation of down flow hydrodynamics.

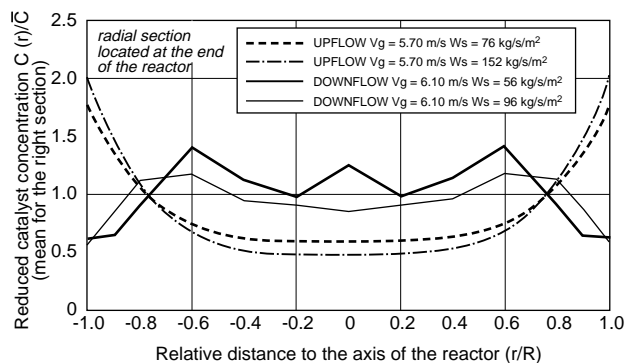

Figure 24

Fluidized bed reactor: influence of hydrodynamics on the radial catalyst concentration.

Upflow results were obtained in the IFP large circulating fluidized bed cold flow facility by gamma-Ray scanning. Downflow results were observed in the IFP downflow circulating fluidized bed using an optical-fiber system; the reduced catalyst concentration appears more homogeneous in downflow. Less catalyst back-mixing and much more homogeneous contact is therefore expected in upflow riser technology.

4 INSATURATED HYDROCARBONS FOR PETROCHEMISTRY

Even more than refining, the petrochemical industry finds itself facing a considerable technological renewal, leading it to reconsider its situation, both in terms of equipments, processes and flow-sheets. Furthermore, the benefits will extend to its neighbors (refining and chemistry), which will be provided with the technology they increasingly need to meet the new quality requirements.

About **olefins**, especially ethylene, an average annual growth of 4.9 percent between 1992 and 1997, and of 3.6 percent, from 1997 to 2005, seems a reasonable prospect. This demand, estimated in 1993 at just over 63 Mt with a production capacity of approximately 73 Mt, can be expected (Fig. 25) to rise to nearly 90 Mt in the year 2000 and to 105 Mt in 2005.

This should make it possible to restore the plant utilization rates to more than 90%, even approaching 95%. In the case of propylene, the growth will probably be still greater (5.9% between 1992 and 1997, 4.1% between 1997 and 2005). Most of the outlets are expected to be located in the Far East (40 percent), against 20 percent in North America and 18 percent in Western Europe.

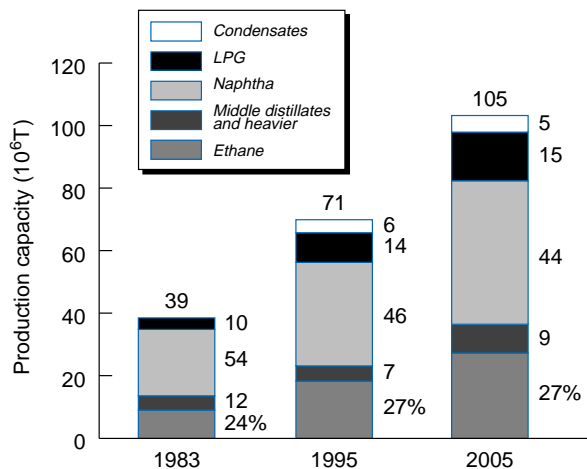

Figure 25

Ethylene world production: nature of the feedstocks.

Steam-crackers still predominate in the manufacture of ethylene and propylene. A first requirement deals with capacity, modern units having ethylene capacities on the order of 500 000 t/y. This implies successive debottlenecking of existing units which will be pursued. Secondly, these plants must acquire as much flexibility as possible with respect to feeds different from the design feedstocks: mostly ethane and LPG in the United States, naphtha in Europe and Japan. These units will need to take advantage of other available feeds, particularly gas condensates. Another possibility is recycling to steam-cracking the less desirable product such as the C₄ and heavier streams. The problems associated with such recycling are well-recognized: downgraded cracking conditions to limit the coking rate, shorter running times between decoking. Technological improvements such as continuous decoking of both furnace tubes and transfer line exchangers may remedy at least some of these problems. Third, the selectivity towards the most useful products must be optimized. The demand for ethylene is showing a slower growth than the demand for propylene and is favorable for the older plants not yet optimized for the high severities required for maximum ethylene production. However, the ancillary processes, mainly selective hydrogenation and the treatment of heavier olefins, must be taken into account in that they significantly alter the main product yields.

This situation, with the dominant role being played by steam cracking, may gradually change. Other processes may help to better adapt the balance of products

from a steam-cracker to an evolving market. From this point of view, a strong competitor will certainly appear in the next years: the so-called advanced short contact time fluid catalytic cracking. Already a large source of propylene (especially in the United States and Europe), the advanced FCC might become an important source of ethylene and C_4 and C_5 olefins. For this objective, some advances are still required in several areas of the FCC technology. A very strong incentive exists for such an objective in connection with gasoline reformulation.

For example, there is a move to produce, with new catalysts, more olefins with the FCC unit. This increased olefins content of the C_3 - C_4 and C_5 cuts from cracking products can be get by adding to the FCC catalyst small quantities of ZSM5 zeolite as additive (Fig. 26). A preferential promotion of propylene formation is observed and the higher olefins content is directly linked to the decreasing of the hydrogen transfer reaction which consumes some of olefins provided by the cracking of the C-C bonds but require more open zeolite structures than those of ZSM5.

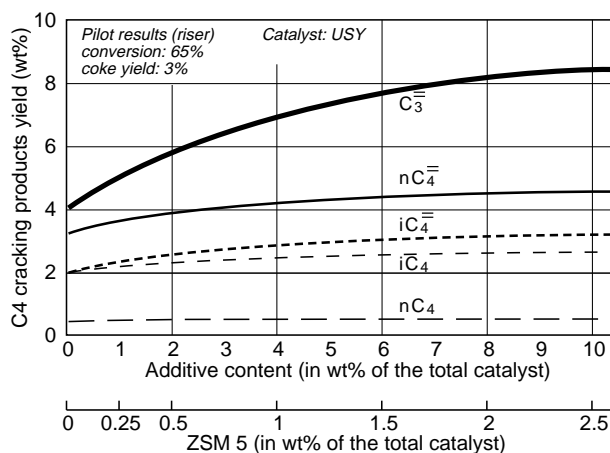

Figure 26

Influence of ZSM-5 additives on olefins content of the cat cracking C_4 cut.

Valorization of the C_4 and C_5 olefins thus obtained can follow now a large number of new ways. The Figure 27 shows an example of the C_4 cut ex-stream cracking post-treatment. After separation or selective hydrogenation of butadiene-1,3, the isobutene of the C_4 cut reacts with the methanol to give MTBE thanks to an etherification process using a catalytic distillation column. The residual butenes undergo then an isomerization through the Iso-4 process. It deals with **skeletal**

isomerization of normal butenes for increasing strongly the isobutene production and pentenes. This process (Iso-4 process) uses a simplified version of the continuous catalyst regeneration (CCR) technology, developed for cat reforming. But with ethylene, the butenes 1 and 2 can also feed **metathesis unit working on an ethylene-normal butenes mixture** (Meta-4 process) to get propylene. Again, CCR technology constitutes the technical heart of this process with a rhenium based catalyst.

In the next future, the interconversion-transformation processes of olefins to other olefins will find increasing applications for adapting the production of large petrochemical complexes to a rapidly changing market.

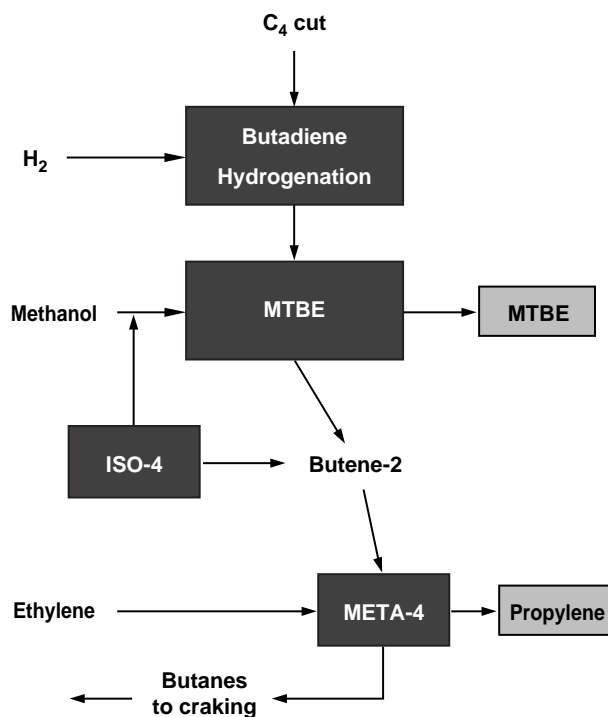

Figure 27

Steam-cracking: C_4 cut upgrading via hydrogenation, isomerization and metathesis.

In the field of **aromatics**, there is also a dominant technology for obtaining the monoaromatics, benzene and xylenes: the catalytic reforming of naphta. Up to now, the reforming units producing aromatics for petrochemical have been generally distinct from those producing high octane gasoline in a refinery, with few exceptions. Again, this situation may change because of the motor fuel reformulation problems we have mentioned previously. The reforming unit is now operated

at high severity so as to maximize hydrogen production for a given yield of aromatics, thus becoming very similar to a dedicated aromatics production unit. At the same time, aromatics content in the gasoline pool will be limited so that aromatics extraction may be used to meet the maximum allowable level of a given type of aromatics. Another similar source of aromatics is found in pyrolysis gasoline (especially benzene). Hence, in the medium and long term, a synergy between refining and petrochemicals is likely to appear in the field of aromatics. This implies significant resetting of the corresponding processes (including catalyst replacement), together with adapted separation technology and also catalytic treatment to eliminate minor impurities (such as small amounts of olefins in the aromatics cuts).

In terms of chemical engineering, the technical renewal of petrochemistry implies very close control of the hydrodynamic conditions in existing reactors, adapting advanced reactor technologies whenever necessary and introducing new separation techniques.

Optimization of **fixed bed reactors** is still a problem. Seemingly uncomplicated, processes like fixed bed selective hydrogenation, used as ancillary processes with steam-crackers, deserves nevertheless improvements for obtaining optimum yields of the main products, especially when the new, multimetallic, high-selectivity catalysts are used. In fact, they generally work under complex hydrodynamic conditions (triphase reactors, high concentration gradients) with difficult local temperature control and high sensitivity to hydrodynamic regimes.

Advanced reactor technologies are obviously required in several fields. Adaptation of continuous catalyst circulation and regeneration or fluidized catalytic cracking reactors to petrochemistry purposes are good examples of such kind of problems. However, a rational approach is made particularly difficult by the complexity of the reactor geometry, by the limited scientific knowledge in the field of solid transport and by the lack of detailed kinetic data on side reactions.

New separation technology is another important area for the improvement of existing petrochemical complexes. A typical example is the technical advances that has recently appeared for the "cold box" of steam-crackers where the use of solvents together with columns gives to the separation section more flexibility (and lower operating costs). Separation technologies based on solid adsorbents already play a major role in the

field of petrochemicals, e.g. separation of paraxylene by the simulated countercurrent technology (*UOP Parex* technology), separation of n-iso paraffins, elimination of impurities by adsorption in cyclic processes (pressure swing adsorption). Since 1987, an important research and development project has been launched by *IFP* to propose a competitive process (the *Eluxyl* process) for xylenes separation by simulated countercurrent adsorption; the Figure 28 shows a view of the large demonstration plant based on this technology and erected at the *Chevron's* Pascagoula refinery in 1994. Besides, the industrial production of the required high selectivity adsorbents has been started. The hybrid version of *Eluxyl* combines the best factors of adsorption and crystallisation units. The stand-alone version of *Eluxyl* provides high purity paraxylene and present a good potential for improvements due to its numerous innovative features.

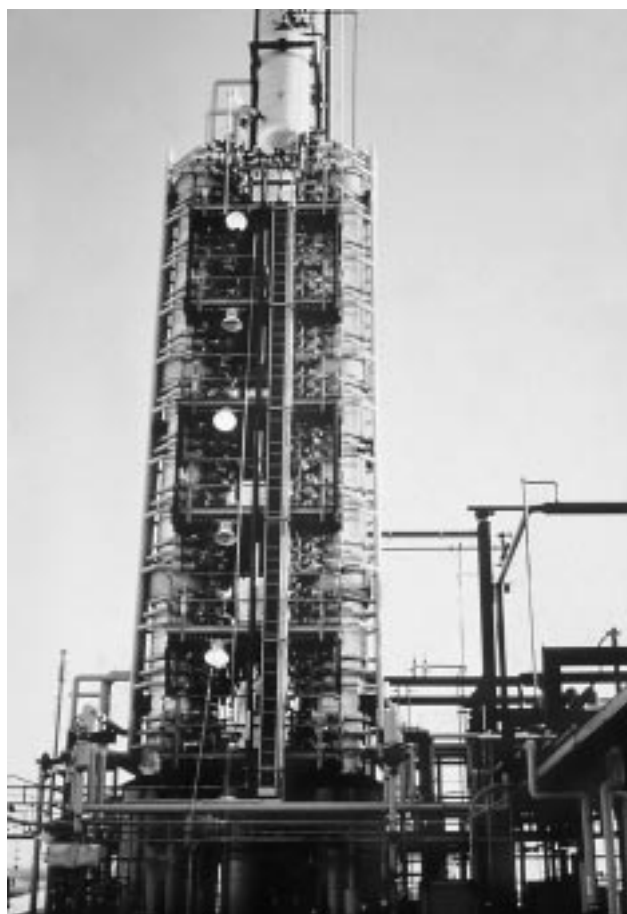

Figure 28

View of the *Eluxyl* process demonstration unit erected at the *Chevron* refinery of Pascagoula (USA).

CONCLUSION

By way of conclusion, I would lay stress on the following points. The major evolution of both refining and petrochemistry industries requires significant improvements of the existing processes and development of new ones. Some of the involved scientific problems such as selective isomerization of C₇-C₉ paraffins for manufacturing new gasolines bases, naphthenic ring opening for improving diesel oil or low pressure resid hydroconversion, represent very difficult subjects. Also the future of refining and petrochemistry is largely linked to the

R&D ability to answer in due time to their main challenges. This implies among others to take full advantage of the accumulated scientific and technical experience, to use the more advanced methods of process modeling and to look for R&D association opportunities, mainly for industrial scale demonstration operations.

The author would thank some *IFP* research engineers for their kind contribution: Eric Benazzi, Pierre Galtier, Thierry Gauthier, Yves Meimon and Frédéric Morel.

Final manuscript received in August 1997