



**HAL**  
open science

## Modelling engine operating space for DoE calibration methods

Fabien Chaudoye, Michel Castagne, Delphine Sinoquet, Francois Wahl

► **To cite this version:**

Fabien Chaudoye, Michel Castagne, Delphine Sinoquet, Francois Wahl. Modelling engine operating space for DoE calibration methods. Conference design of experiments (DoE) in engine development, Jun 2009, Berlin, Germany. hal-02284320

**HAL Id: hal-02284320**

**<https://ifp.hal.science/hal-02284320v1>**

Submitted on 11 Sep 2019

**HAL** is a multi-disciplinary open access archive for the deposit and dissemination of scientific research documents, whether they are published or not. The documents may come from teaching and research institutions in France or abroad, or from public or private research centers.

L'archive ouverte pluridisciplinaire **HAL**, est destinée au dépôt et à la diffusion de documents scientifiques de niveau recherche, publiés ou non, émanant des établissements d'enseignement et de recherche français ou étrangers, des laboratoires publics ou privés.

# Modelling engine operating space for DoE calibration methods

---

Fabien Chaudoye, Michel Castagné, Delphine Sinoquet, François Wahl

## Abstract

The tightening of standards on pollutant emissions have led car manufacturers to develop more complex strategies of engine control, with an increasing number of parameters to be tuned. New calibration methods based on statistical modelling and DOE have become necessary to cope with this complexity.

Determining the engine operating space is a major issue for such methods, in order to achieve the design of experiments and to know in advance if optimized tuning built from engine responses modelling could really be played on the engine.

This paper presents a pragmatic approach for modelling this operating space, while addressing the experimental procedure and the mathematical design. Results obtained from a common rail diesel engine illustrate methods for local approach (with operating points defined by speed and load) or global approach (including speed and load as parameters). Examples of DoE into this design space are also presented.

## 1. Introduction

Nowadays, number of engine control parameters drastically increases. Consequently, DoE methods are now commonly used to reduce cost, delay and improve calibration process. Advanced methods [1] based on modelling require some specific developments for several steps of the engine calibration: test planning, modelling, optimizing, etc. This paper will mainly discuss the first step of the calibration workflow, i.e. engine operating space (OS) determination. This step is crucial, since it allows to get the domain into which DoE could be built and control parameters could be optimized, with the insurance that every parameter combination will be performed correctly by the engine.

Instead of an iterative approach such as Rapid Hull Determination [2], we proposed to develop a physical and pragmatic approach to find the limits of OS. This will lead to basic OS modelling, easy to use during other calibration steps as modelling or optimization. This paper presents both local OS (with operating points defined by speed and load) and global OS (including speed and load as parameters) determination. Test plan problematic is also addressed. Purposes are illustrated with results from a EURO4 production 4 cylinders diesel engine operated at constant speed-load (stationary) in standard hot conditions on a fully instrumented test bed using Morphée<sup>®</sup> as automation system.

## 2. Operating space definition: local approach

This section describes local OS modelling method, i.e. OS determination for a given operating point defined with speed and load.

## 2.1. Context

Most of industrial calibration methods based on DoE use simple domain definition, frequently a simple hypercube defined with minimal and maximal fixed bounds for every control parameter. The main advantage is a simple and fast determination, as well as an easy modelling of both engine domain and engine responses because of the limited variations of the control parameters. However, an important drawback of such domain is that it is significantly reduced in comparison with physical engine limits. Thus, depending on knowledge about engine behaviour, optimal parameter settings can be out of the defined hypercubic domain. Practically, the modelling space is limited to the domain used for DoE (validity domain of the model) in order to avoid extrapolation. Sometimes, the optimizer will find optimal settings at the limit of the domain. In such case, the full process (research of bounds, design of experiments, tests, engine responses modelling and optimization) has to be done again, until optimal parameters setting are into the limits of the domain ([3]). Figure 1 shows this iterative process, which can be cumbersome and time-consuming.

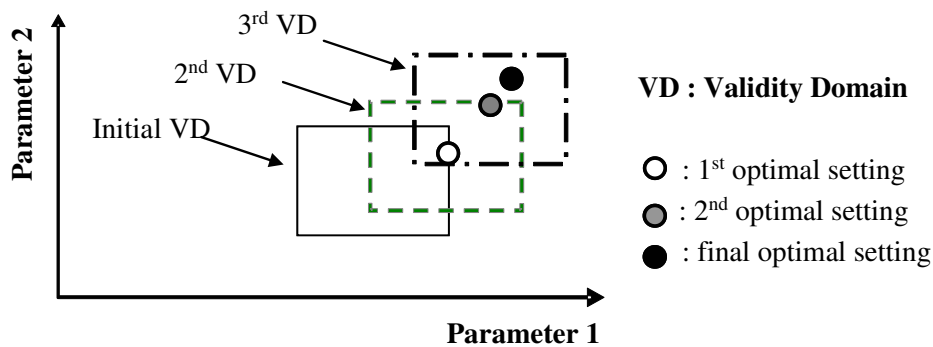

Figure 1: progressive optimization

The aim of our study for local approach is to determine the complete OS with reduced test duration and to model the limits of this OS with simple mathematical expressions, easy to use in further operations as design of experiments or optimization. Such wide OS determination is very useful for several applications. First if we use the entire OS for designing the experiment, we can ensure that optimal settings can not be out of this domain and we avoid the iterative process described above. If a restricted domain is preferred for design of experiments, complete OS knowledge allows to define a new domain for iterative process without redoing preliminary tests. When using advanced calibration methods, large OS can be more easily used for merging local models to build a global model ([3]).

## 2.2. Local operating space limits

Limits of OS can either be hard limits as maximal air mass flow, minimal/maximal boost pressure, or limits defined with subjective criteria (AFR, opacity, stability, etc.) as minimal air mass flow, or minimal main injection advance. Figure 2 shows the limits of operating space in the 2D space (air mass flow and boost pressure), for given injection parameter setting in comparison with a usual hypercubic reduced domain designed into the OS.

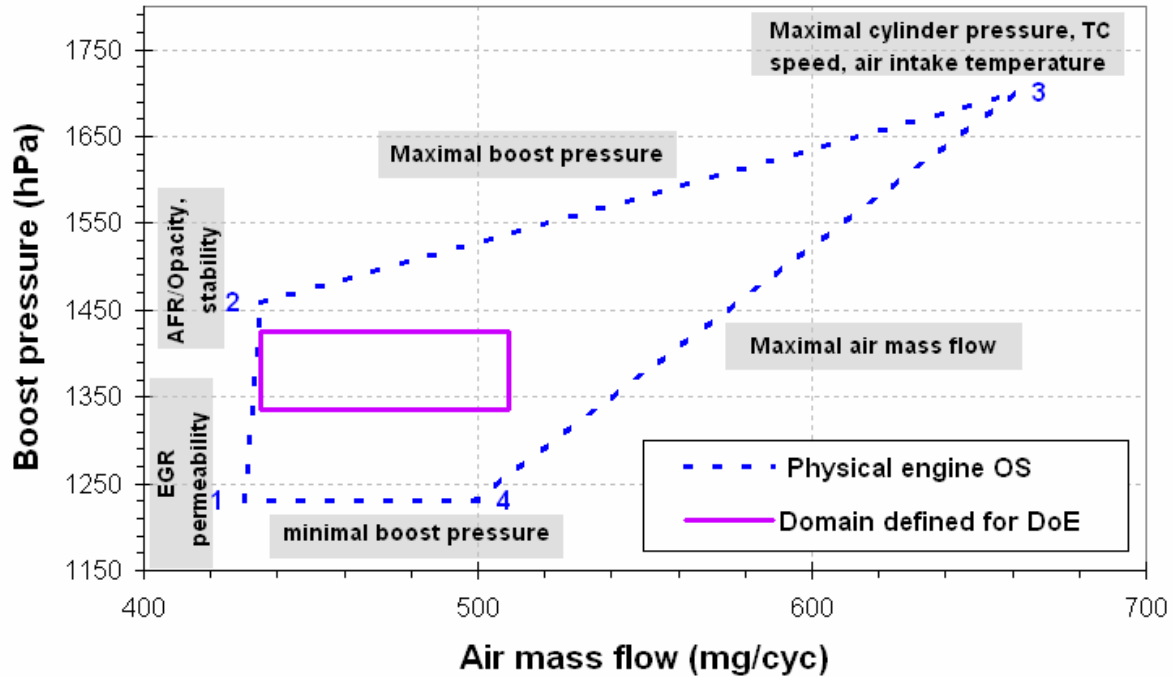

Figure 2: limits of operating space and example of hypercubic domain in 2D space (air mass flow / boost pressure)

Experience shows that physical engine air loop limits could be modelled with straight lines for fixed injection parameter settings. The maximal boost pressure directly depends on turbocharger characteristics and evolves linearly with air mass flow. The upper air mass flow limit depends on global engine permeability. Thus it mainly evolves linearly with boost pressure, and also varies slightly with engine speed and load. This limit is not very sensitive to injection parameters. The lower boost pressure limit is related to turbocharger permeability, and also depends on atmospheric pressure. The last air loop limit is the minimal air mass flow. It is a subjective limit unlike previous described limits which are physical limits. Thus, it mainly depends on criteria chosen to define it. AFR limit is often used for this purpose. Linear models also present good results for this limit. However, if OS limits seem to be easily determined with a simple shape in a 2D space, it becomes more complex with an increasing number of parameters. Figure 3 shows OS shape in a 3D space air mass flow, minimal/maximal boost pressure/main injection advance.

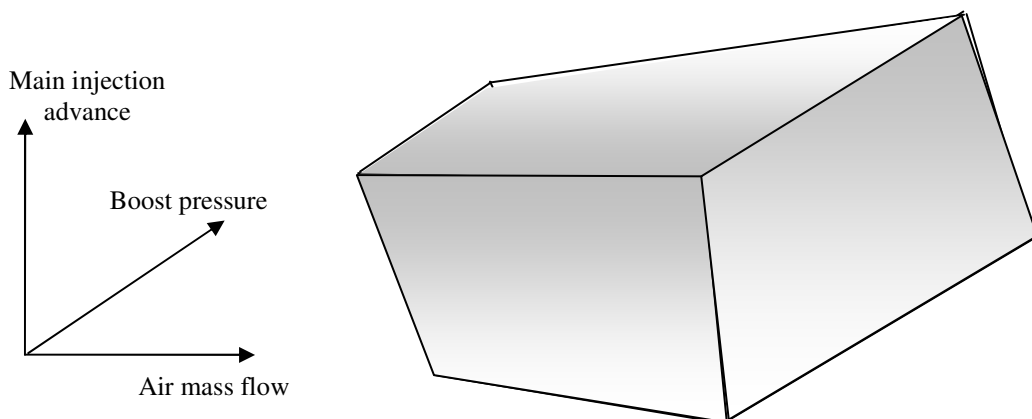

Figure 3 : example of enlarged OS in a 3D space

With one more parameter, OS general shape is significantly modified. Indeed, every limit is impacted by other parameters. For example, when main injection advance is decreasing, maximal admissible boost pressure is increasing since there is more energy contained in gas for turbocharger. In another way, main injection advance can be reduced when air mass flow increases (i.e. EGR rate decreases) since combustion is more stable. Thereby, with many parameters, OS shape is much more complex since there are various interactions between parameters.

The pragmatic approach presented in this paper only considers relevant physical limits. For example, it is assumed that there is no need to widely increase main injection advance for low load operating points, although it is not limited with too high cylinder pressure, but due to high NO<sub>x</sub> emissions and noise value. Thus, this approach tries to define engine limits as wide as possible, by introducing engineering knowledge to keep most relevant part of the OS.

### **2.3. Test facilities and procedure of OS determination**

All tests presented in this paper were performed with a 1.6L diesel engine equipped with a common rail injection, a variable geometry turbocharger and an EGR cooling system. The engine control is mainly based on maps. All tests were carried out with a simple injection strategy, i.e. a single pilote injection besides the main injection. Thus, six engine control parameters were used to define OS limits: air loop parameters, including boost pressure and air mass flow, and injection parameters including injection pressure, main injection advance and pilote injection advance and quantity. The test cell used during tests is equipped with Morphee [4] as cell supervisor, including Automapping component to design tests. This configuration makes it possible to perform tests in an automated way without the presence of operator, which drastically improves the productivity of the global process. The cell is also equipped with several measurement systems: engine and fluids temperatures, cylinder pressures, cell data, pollutants analyser, smokemeter and fuel consumption measurement.

The OS determination is experimentally performed in two steps.

1. The first step is executed manually and consists of the determination of injection parameters bounds. Most of these bounds are considered as fixed. These are determined to allow a wide and relevant (considering pollutants emissions, noise, consumption, etc.) range of settings. It also consists of the determination of a criterion to define minimal air mass flow limit.
2. The second step consists of looking for air loop limits for given injection parameters. As explained before, air loop limits are straight lines: thus, two points are enough to model limit for given injection parameters.

Specific developments were done to determine minimal air mass flow limit. This limit is gradually determined with continuous measurements (opacity, AFR or engine stability) until a bound defined at the first step is reached. Figure 4 shows principle of automatic test and iterative determination of minimal air mass flow limit. In order to shorten time spent in OS determination, no stabilisation is expected during test, since pollutants, temperature and other cell data are not analysed. In this way, about one minute is required to find one point at the maximal air mass flow limit, and about two minutes to find one point at the minimal air mass flow limit, due to iterative process described previously. Thereby, it is possible to perform OS determination for each operating point in a short duration. Typically six minutes are needed to define air loop limits for a given injection parameter settings, and a standard of fifteen combinations of injection parameters are usually performed. Thus, around three hours (including transitory states between combinations) are necessary to define a complete OS.

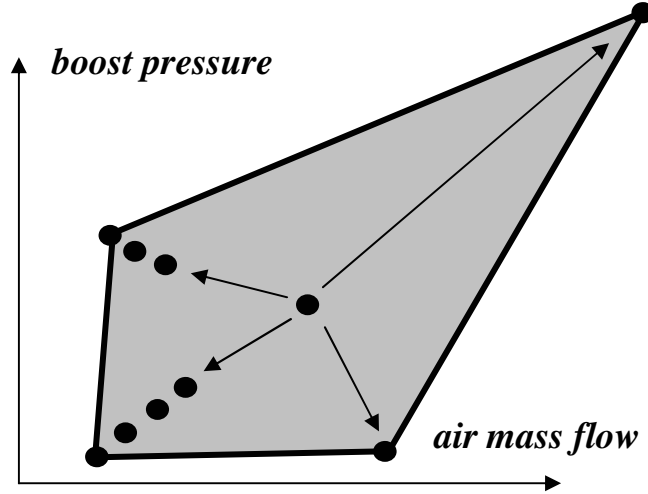

Figure 4: Principle of automatic test to determine air loop limit with iterative method

The minimal air mass flow limit is not the only one to be determined with an iterative process. For example, lower limit of main injection advance is also determined with such a process. When air mass flow is increasing, the combustion is more stable, and CA50 (crank angle where 50 percent of burnt fuel) which is a relevant combustion criterion increases. Thus, it is possible to reduce main injection advance. Criterion to define lower main injection limit is indeed the CA50 equivalent of the value obtained for minimal air mass flow.

## 2.4. Local operating space modelling

OS model has to meet several requirements. It has to be simple enough to be easily used during the next step of the workflow: design of experiments. And it also has to be accurate enough, to ensure that every set of parameters defined for the test is physically realizable. After processing the experiments, we can model the constraint area in all directions. The main idea is to model the maximal and minimal limits for each variable:

$$y_{\min}(p_1, \dots, p_n) \leq y \leq y_{\max}(p_1, \dots, p_n)$$

where  $y$  is a given variable and  $(p_i)_{i=1..n}$  are the other variables.

As shown in Figure 2, OS shape seems simple, thus, linear constraints were used first, and expressed as followed:

$$y_{\min} = a_0 + \sum_{i=1}^n a_i p_i \quad \text{and} \quad y_{\max} = b_0 + \sum_{i=1}^n b_i p_i$$

The model coefficients  $(a_i)_{i=0..n}$  and  $(b_i)_{i=0..n}$  are estimated from experiments of the specific space design algorithm implemented on the test bench.

In the case of hypercubic limits, we have:  $y_{\min} = a_0$  and  $y_{\max} = b_0$

Figure 5 and Figure 6 present modelling experimental correlation diagrams for the four air loop limits. Dots represent points used for modelling, and circles represent validation points which are not used for modelling, and thus are used to judge model prediction capability. Results are fairly good for the three physical limits: lower and upper boost pressure limit and maximal air mass flow. Minimal air mass flow results present a worse accuracy, since this

limit is subjective, and directly depends on the way it is defined. However, accuracy obtained with these models is sufficient to ensure feasibility of all the parameter settings.

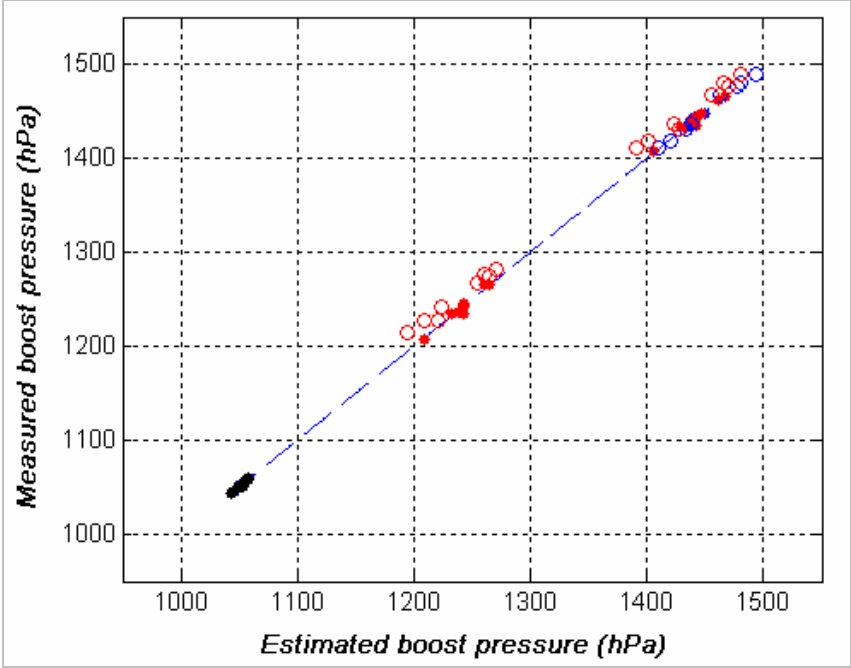

Figure 5 : correlation diagram for three physical limits

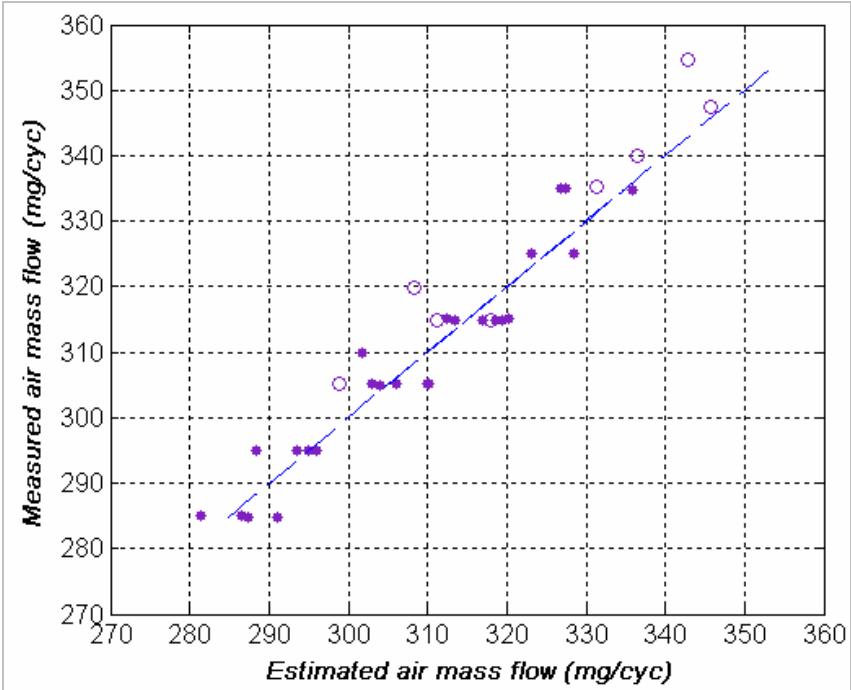

Figure 6: correlation diagram for minimal air mass flow limit

Figure 7 presents several constraints projected on 2D planes for a given OP. On the left, air loop limits are presented for several main injection advance and rail pressure values. As described in section 2.2, OS limits depend on these parameters: trends are well reproduced by the models. On the right, influence of air mass flow on main injection advance is represented: when air mass flow is increasing, combustion is more stable, thus, minimal main injection advance limit is decreasing. Otherwise, when main injection advance is decreasing, there is

more energy available for VGT, and for a given boost pressure, minimal air mass flow is increasing.

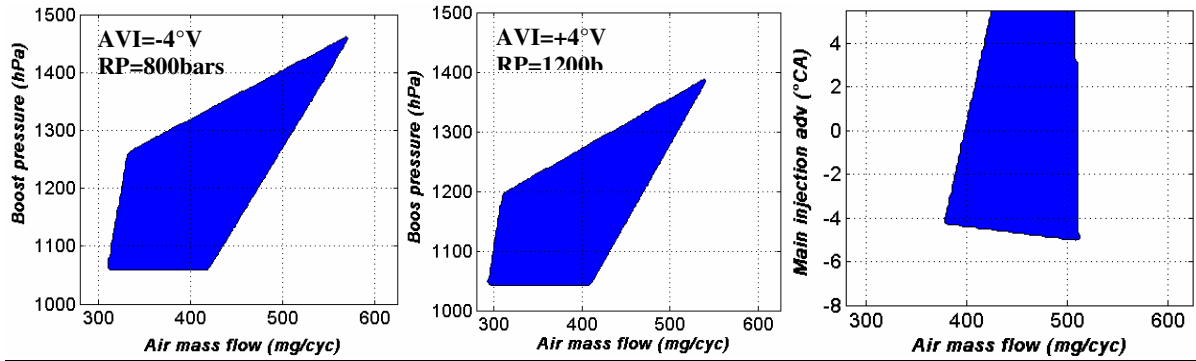

Figure 7: example of 2D projection of local OS model

The advantage of this modelling clearly appears in comparison with hypercubic approach, as presented in Figure 8. For a given OP, standard hypercubic domain and enlarged OS are compared. The OS enlargement avoids hypercubic OS drawbacks, i.e. the possibility that the optimum lies outside the OS. However, this expansion requires modifying test plan methods. This point will be discussed in next section.

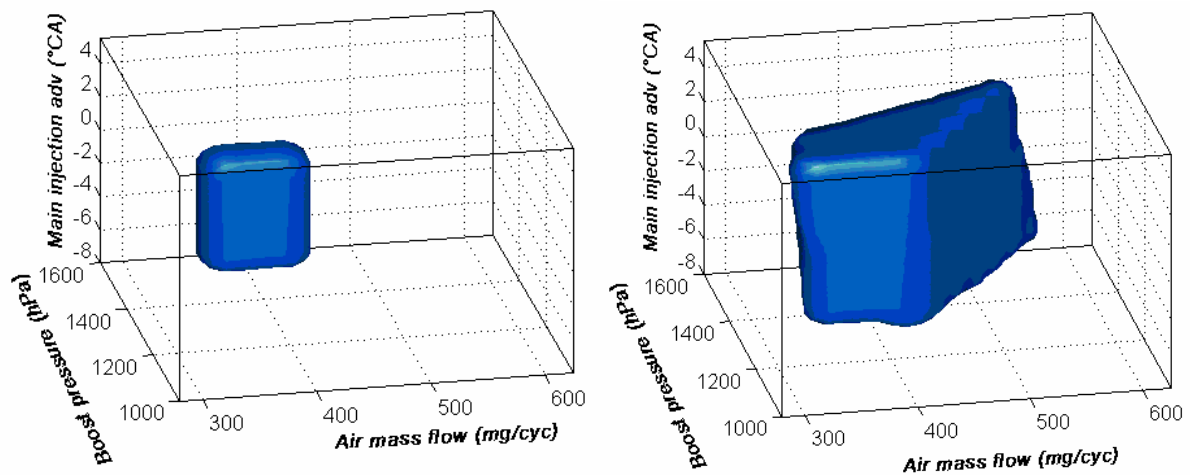

Figure 8: comparison of local hypercubic domain (left) and enlarged OS (right)

## 2.5. Test plan development

The aim of the test plan is to build response surfaces approaching as much as possible the real behaviour of the engine in the chosen local area. In the remainder of this section, we start from a simple design in a hypercube that we make more complex step by step to finally designing the experiment in the entire OS.

If domain was hypercubic, strategies for designing experiments would be well established. Usually in this kind of setting, the area to explore is relatively narrow in comparison to the maximal possible variation of each parameter, as it has been noted a couple of times. Thus, a polynomial representation of the studied engine response (CO<sub>2</sub> emission for example) performs locally well.

In this case, for six engine control parameters, and a quadratic polynomial, 28 coefficients have to be determined, meaning that at least 28 experimental points have to be gathered. However, it is wise and good practice to add some points within the domain and to keep an



other set of experiments for validation. Indeed, we need 40 points as a minimal. To choose the experimental trials, D-optimal designs [6] can be put into practice.

But even in a hypercubic domain, the real behaviour of the responses may be not so comfortable. In certain cases (especially for particles representation), we need a cubic polynomial to take into account all possible variations. Neglecting all the order three interactions, 34 coefficients are now to be determined, and the number of needed experimental points increases accordingly.

If we still want to refine our model, it can be noticed that the shape of the answers will depart more from the expected model as we approach the edges and the corners of the domain. So it sounds like a good strategy to include all the corners in the design to potentially avoid important residues for these areas. In this case, still within a six dimension parameter space, there are 64 corners to be tested. Furthermore, added points inside domain are still needed.

Now, it appears that the real OS is not hypercubic but is limited with linear constraints, which are not parallel to the axes. Thus, basic hypercube becomes a complex polyhedra, which can present sharp and thin edges and the number of possible corners increases. For example, we had to treat an example with six additional constraints, and 89 corners were counted.

A way to valid engine responses model consists of comparison between model prediction and simple experimental trends. For instance, experts build profile variations of the answers, meaning that all the parameters are fixed except one, which is varying between the allowed limits. Practically, a possible idea is to include in the test design a few points dedicated to represent the central profiles. Then, starting from the central point (P) of the domain, two points are taken on both sides of P along each direction. Thus 24 experimental trials are added.

At the end, we have around 110 imposed points for a six dimensions case, counting all the corners and the experiments for the profiles. Besides, some few points are defined inside the OS by some space filling algorithm, and some security checks to be sure that all the experimental apparatus does not show any deviation during our experimental campaign, we eventually get 140 experimental trials to run. Figure 9 gathered all experimental points planed for a given speed and load operating point, in the 2D plane boost pressure and air mass flow.

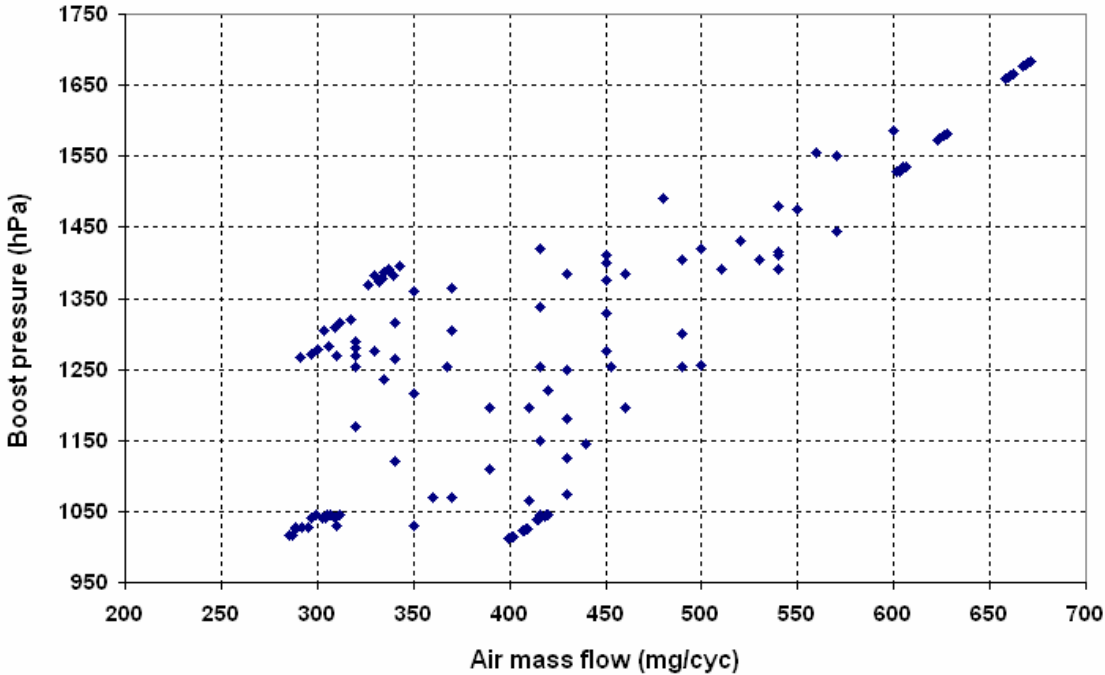

Figure 9: example of local DoE in 2D space projection

### 3. Operating space definition: global approach

This section describes global OS modelling method, i.e. validity domain determination including speed and load as parameters.

#### 3.1. Context

The time and cost constraints imposed by the automotive industry, lead to ever shorter product development. Thus, advanced calibration methods answer to these constraints, and aim to significantly reduce the time development of vehicles. Global approach for calibration, considering load and speed as parameters, reduces time spent for whole calibration workflow, since a unique DoE is necessary to model engine responses for entire domain (or several DoE if this domain is divided in several zones with common parameters). However, problematic is more complex than for local approach, and specific development were realised. Once again, OS determination is an important step for this calibration approach, and directly influences quality of global DoE and potential of optimization. For this last step, it is necessary to ensure that bounds for every parameter are wide enough to complete objectives of calibration campaign. Good OS models are also suitable for test realisation. Indeed, for mid and high load and speed zone (considering normalised cycle load and speed zone), many criteria are closed to engine limits, like intake manifold temperature, temperature before VGT, etc. If OS models are not precise enough, many settings of parameters planed by DoE will be out of OS leading to test bed stops, significantly lengthen test development. Figure 10 presents OS evolution (2D plane Air mass flow / Boost pressure) with load and speed. The aim of the approach presented in this paper is to get model of the OS boundaries. Such a model has to keep simple mathematical expression to be compatible with test plan design and optimisation methods.

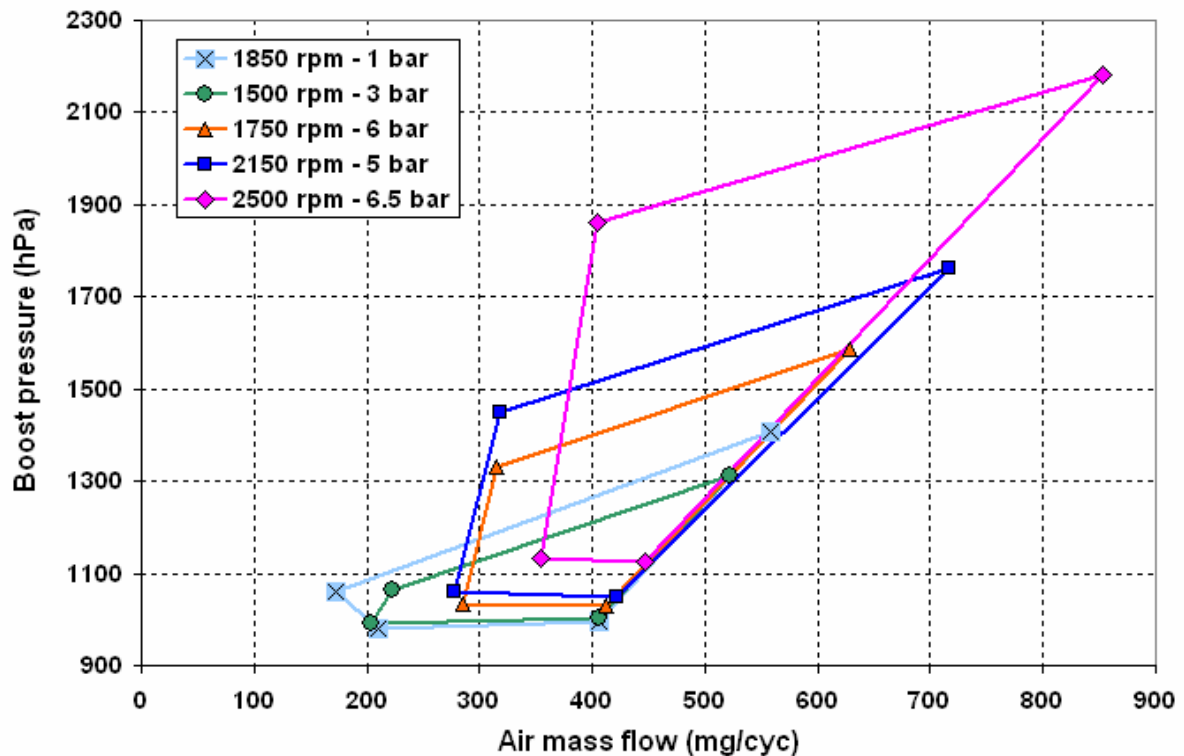
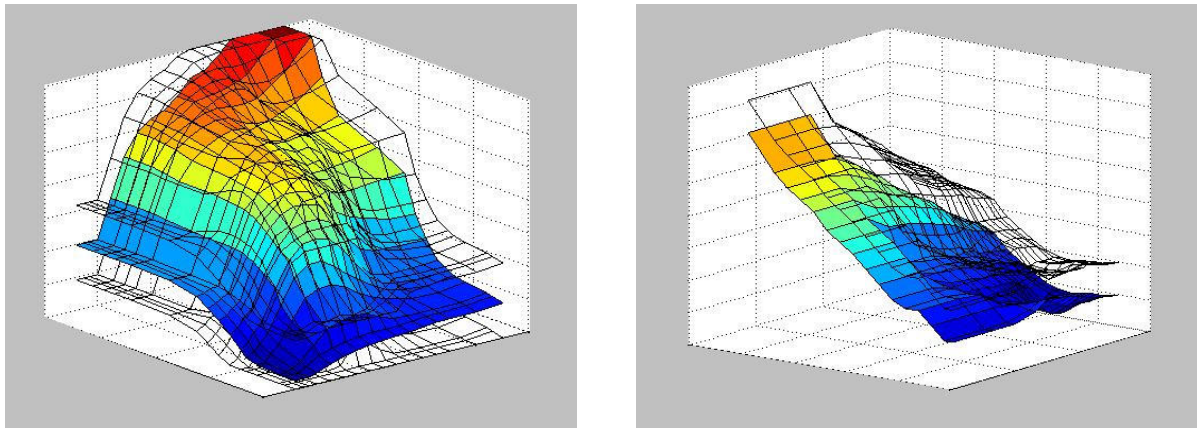

Figure 10: evolution of local OS with load and speed

### 3.2. Global operating space modelling

The OS modelling has to fulfil several requirements. It has to be compatible with simple DOE, model has to be simple enough to be used for DOE tools and it also has to be precise enough to ensure good development of test. Pragmatic approach was favoured and different types of modelling were defined for several parameters. Local approach and its very satisfying results, significantly inspire global approach method. Considering load and speed limits, simple linear models delimiting normalised cycle working area were used.

For injection parameters, lower and upper limits are defined with maps. Amplitude of variations is defined thanks to engineering experience, and has to be compatible with calibration objectives. This type of model was chosen from local approach experience where fixed bounds for injection parameters led to satisfying results in term of potential for optimization. These models are also mathematically simple, since limits come down to simple bounds for fixed speed and load. Figure 11 presents example of limit maps for injection rail pressure and maximal main advance injection.



*Figure 11 : example of limit modelled with cartography*

As in local approach, the most critical point for global OS is air loop limits. Two methods were tested.

The first method consists in using local data gathered for every operating point, and in modelling limits with low degree polynomials. Some interaction terms of the polynomial models were removed in order to obtain linear models for fixed speed and load, to be similar with local approach. This first type of model led to satisfying results, however, a lack of data within critical zone in mid and high speed and load drove to a poor precision of the model in this zone. Consequently some problems appeared during DoE test.

The second method is based on a dedicated automatic test covering entire normalised cycle area. This second method presents the advantage of getting data well distributed all over cycle area, and not only for a limited number of operating points. This is particularly important for precision, and it also reduces overall test duration. The difficulty consists in defining a criterion to find minimal air mass flow limit for several speed and load combinations. A model of AFR limit, defined from local approach experience, has been used as criterion. In a limited time, it is possible to gather enough information to model global OS. Figure 12 and Figure 13 present modelling experimental correlation diagrams for the two limits maximal and minimal air mass flow. Crosses represent point used for modelling, and circles represent validation points. Results of maximal air mass flow limit are very good, while minimal limit presents worse precision, but still acceptable. This requires to define correctly global AFR criteria in order to ensure that planned parameter settings are physically realisable. The correlation diagram presents some high residues for air mass flow value around value of two hundred milligrams per cycle. This is due to permeability limit of EGR system, which does

not allow to reduce air mass flow for very low speed and load OP. Model does not well represent this trend, with no consequences about engine security since air mass flow is physically limited in this area and no unfeasible point could be performed..

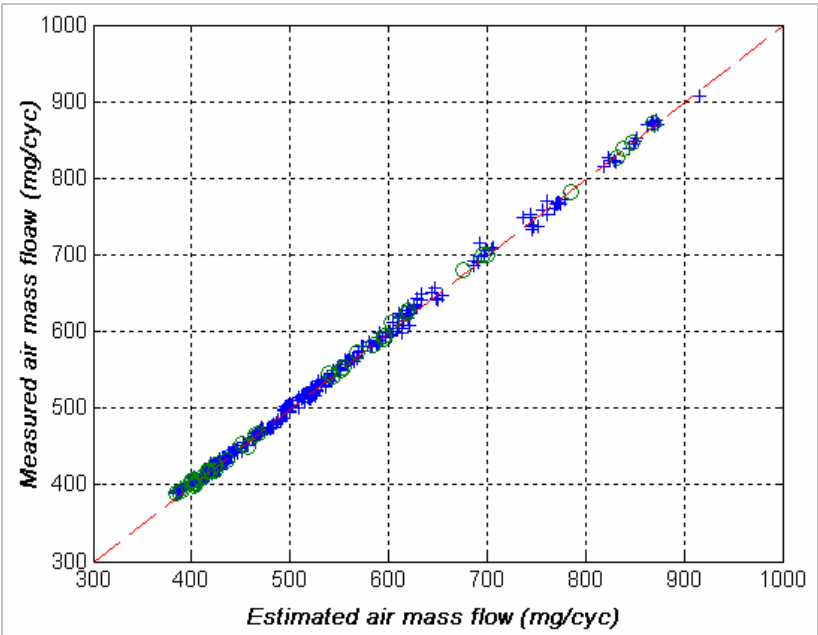

Figure 12: correlation diagram for maximal air mass flow limit (global OS)

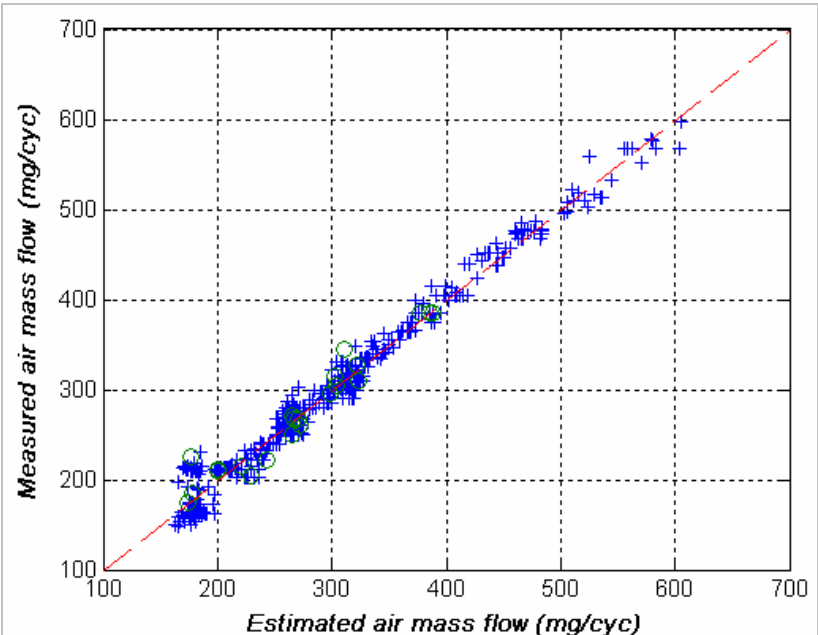

Figure 13: correlation diagram for minimal air mass flow limit (global OS)

The next figure presents comparison for air loop limit between local and global OS models for a given operating point. As expected with good results presented previously, global OS is similar with local one, which validates global OS model. Furthermore, duration dedicated to this global approach is very encouraging and meets industry requirement. Test planning methods were modified to take into account these more complex models; this point is discussed in next section.

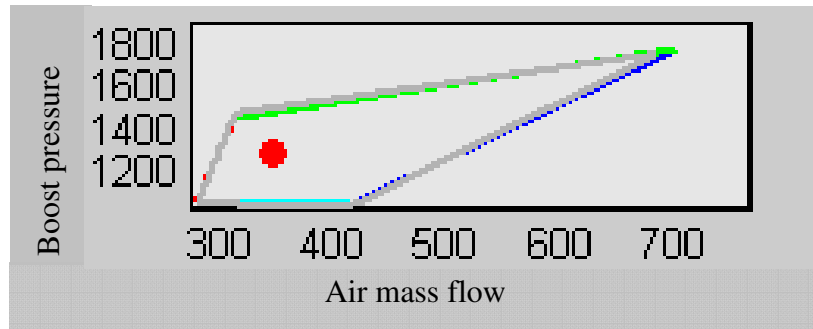

Figure 14: comparison of local and global OS model for given speed and load

### 3.3. Global test plan

Design of experiments in this global setting rests on the same considerations as in local one. At the beginning, the space to be covered is a hypercube, which is limited by a set of constraints as it has been described in the previous sections. But due to the increase of dimensions, eight instead of six (including speed and load), new difficulties arise. Some constraints are not linear, due to the failure of simple models to respond to our objective: much more experimental points are requested to adequately represent the domain.

When all the constraints are non linear, the basic strategy for designing the test plan described above has to be modified. Indeed, it is no longer possible to define the corners, as the edges of the domain can be curved. In our case, experts had to resort to quadratic polynomial to model the limits of the OS.

The proposed approach consists in proceeding in two hierarchical steps, considering local approach experience. Indeed, for a given speed and load, the constraints delimiting OS have to be linear. Thus in a first step, a set of constraints is built over the speed and load domain. In this two dimensions space, we proceed as usual: the basic square (in two dimensions) is limited by constraints which have to remain linear in order to ensure that corners can be defined.

All other constraints which have to be applied on the other parameters can depend nonlinearly on speed and load. However, once the speed and the load are fixed in a second step, these expressions must degrade to a linear convenient form for the six other parameters. The way an experimental point is chosen is quite simple in this way: firstly, a couple of values for speed and load is defined, and secondly, six other parameters are fixed as in the local test plan method.

In our case, with the set of constraints we had to deal with, we found around 400 corners. We added three set of mono parametric variations, which count for about 100 more points. So 500 points are imposed. As we stand in a eight dimensional space, it is not enough to describe it fully: indeed, no specific parametric form of model seems adequate and one has to resort to kriging techniques and space filling design [7].

If two points per dimension are chosen, the whole test design would be composed of 256 experiences. With three points, an overall of 6561 experiences is requested, which can not be afforded. At the end, we compromised for 2000 points (including corners), from which 200 were left out the calibration set and kept for validation only.

To fix these 1500 imposed points, the two steps described above were run iteratively, by random sampling. Clearly, the overall design is satisfactory in the sense that all the prerequisite are fulfilled. But as can be seen in Figure 15, this design is not optimal, some holes and some highly concentrated regions are present. This figure shows also that the limits are non linear.

The final step, once all the requested trials are run, is to build the model, which is done by kriging on 1800 calibration points, the validation is done on the set of 200 points.

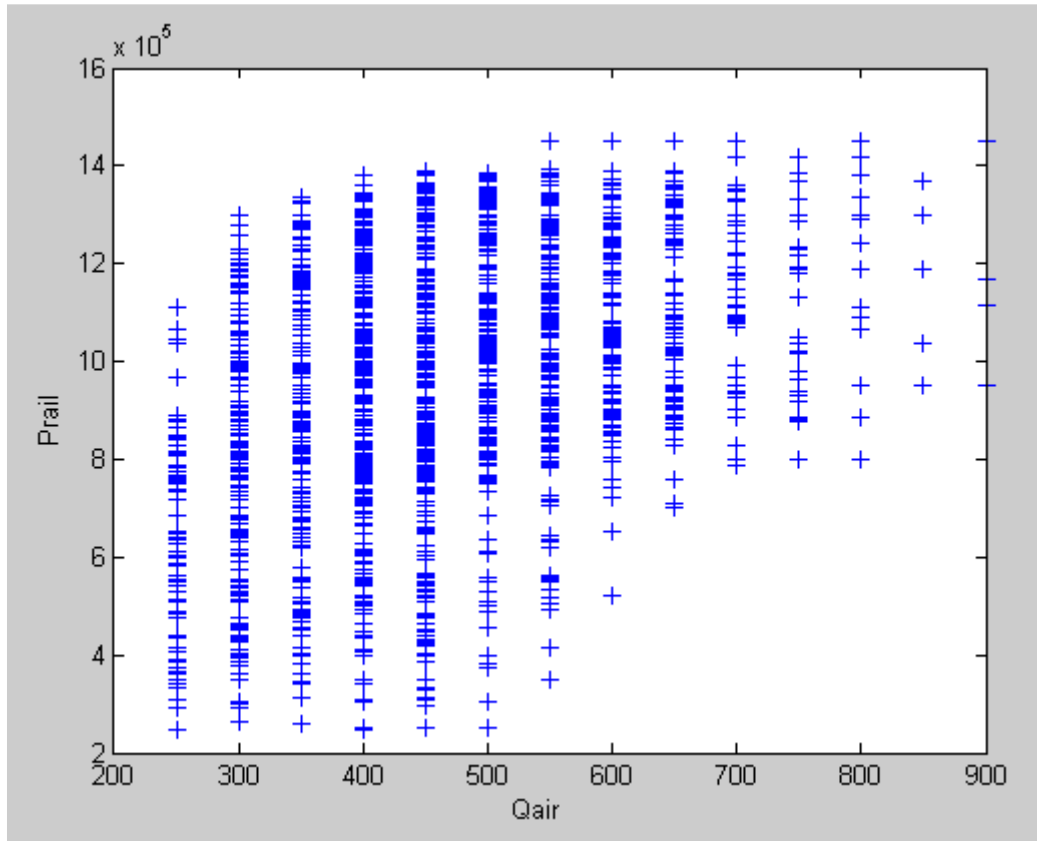

Figure 15 : 2000 experimental points chosen in the Prail (rail pressure) and air flow rate ( $Q_{air}$ ) space

#### 4. Enhancements and outlooks

Method to determine local OS could be improved with a reduced duration dedicated to this step. Time could be saved with optimization of experiments performed during tests. Indeed, about 50 experiments are carried out to determine all linear constraints, including some validation points. This number can probably be reduced to 40 with experience and optimization of design of experiments. Then, test plan method can also be improved. If a wide OS leads to an increasing number of experiments to be done, experience will allow to reduce this number to improve productivity of calibration process and especially test bed experiences.

Besides, methods have to be tested with more parameters, since their number will sensibly increase in the next few years. However, approaches presented seem to be compatible with more injection parameters, and air loop limit determination method will still be valid with a low increasing of time and cost spent for this task.

An important way of enhancement is coupling experimental tests with simulation. Indeed, physical 0D or 1D simulation of the engine could help for determining both local and global OS boundaries. For example upper limits of air loop can be easily determined by the use of a simulator. This would significantly save time at test bench and cost spent for this step of calibration workflow.

## **5. Conclusion**

This paper presents simple and practical methods for determining the limits of engine operating space in order to use DoE calibration methods. Local approach and global approach are both addressed. Experimental test procedures, as well as specific tools have been developed to model these limits. These procedures are run automatically in order to save time and use a test bench 24h a day. Simple modelling of the operating space limits has been set up from the experimental data. Results are satisfying for both approaches in terms of prediction and time spent for tests. These models are used to design the experiments but also as constraints during optimization process [5].

Test planning methods were successfully developed into the modelled operating spaces, in accordance with the type of engine response model anticipated.

These methods have now to be adapted for an increasing number of parameters.

## Literature

- [1] O. Nelles, *Non linear system identification*, Springer-Verlag, 2001.
- [2] P. Renninger, M. Aleksandrov, *A new method to determine the design space for model based approaches*, DoE in engine development II, Berlin, Germany 2005.
- [3] Michel Castagné, Yohan Bentolila, Adrien Hallé, Frédéric Nicolas, Delphine Sinoquet, *Engine calibration : Toward an integrated approach*, DoE in engine development IV, Berlin , Germany, 2007.
- [4] <http://www.d2t.com>
- [5] Delphine Sinoquet, Hoël Langouët, Fabien Chaudoye and Michel Castagné, *Multi-objective constrained optimization of engine maps*, DoE in engine development V, Berlin , Germany, 2009.
- [6] Atkinson, A. C., and A. N. Donev., *Optimum Experimental Designs*, New York: Oxford University Press, 1992.
- [7] T. J. Santner, B. J. Williams and W. I. Notz (2003), *The Design and Analysis of Computer Experiments*, Springer Verlag, New York.

## Acknowledgments:

The authors would like to acknowledge Y. Bentolila, S. Gindre, J.M. Hascoet, F. Nicolas and R. Dauphin for their contribution to this work.



## **The authors:**

Fabien Chaudoye, research engineer in engine development

Dr. François Wahl, project leader in applied mathematics

Michel Castagné, project leader in engine and vehicle calibration

Dr. Delphine Sinoquet, project leader in applied mathematics

All the authors work at IFP, 1 et 4 avenue de Bois Préau, 92582 Rueil-Malmaison Cedex – France.