



HAL
open science

New Ceramic Thermal Barrier Coatings Development in a Spark-Ignition Engine – Experimental Investigation

Bernard Bouteiller, Alain Allimant, Jean-Marc Zaccardi, Jerome Cherel

► To cite this version:

Bernard Bouteiller, Alain Allimant, Jean-Marc Zaccardi, Jerome Cherel. New Ceramic Thermal Barrier Coatings Development in a Spark-Ignition Engine – Experimental Investigation. International Thermal Spray Conference, ASM International, May 2019, Yokohama, Japan. hal-02295138

HAL Id: hal-02295138

<https://ifp.hal.science/hal-02295138>

Submitted on 12 Dec 2019

HAL is a multi-disciplinary open access archive for the deposit and dissemination of scientific research documents, whether they are published or not. The documents may come from teaching and research institutions in France or abroad, or from public or private research centers.

L'archive ouverte pluridisciplinaire **HAL**, est destinée au dépôt et à la diffusion de documents scientifiques de niveau recherche, publiés ou non, émanant des établissements d'enseignement et de recherche français ou étrangers, des laboratoires publics ou privés.



EFFICIENT ADDITIVATED GASOLINE LEAN ENGINE

GV-02-2016 – PROJECT 724084



UNIVERSITAT
POLITÀCNICA
DE VALÈNCIA



UNIVERSITÀ DEGLI STUDI DI NAPOLI
FEDERICO II



New Ceramic Thermal Barrier Coatings Development in a Spark-Ignition Engine – Experimental Investigation

Bernard Bouteiller¹, Alain Allimant¹, Jean-Marc Zaccardi² and Jérôme Cherel²



1) *Saint-Gobain Research Provence, Cavillon, France*

Contact: bernard.bouteiller@saint-gobain.com



2) *IFP Energies nouvelles, Institut Carnot IFPEN TE, Solaize, France*

ITSC, Yokohama ; Japan ; May 29th, 2019

This project has received funding from the European Union's Horizon 2020 research and innovation programme

Funding ≈ 6M€

October 2016 - March 2020

EAGLE project objectives

- Long term fleet target of 50 gCO₂/km (WLTC)

- 50% peak thermal efficiency

- Ultra-lean mixtures (high air/fuel ratio)
- H₂ boosting
- Pre-chamber ignition system
- Optimized intake ports
- **Smart coatings**
- Optimized NOx after-treatment systems

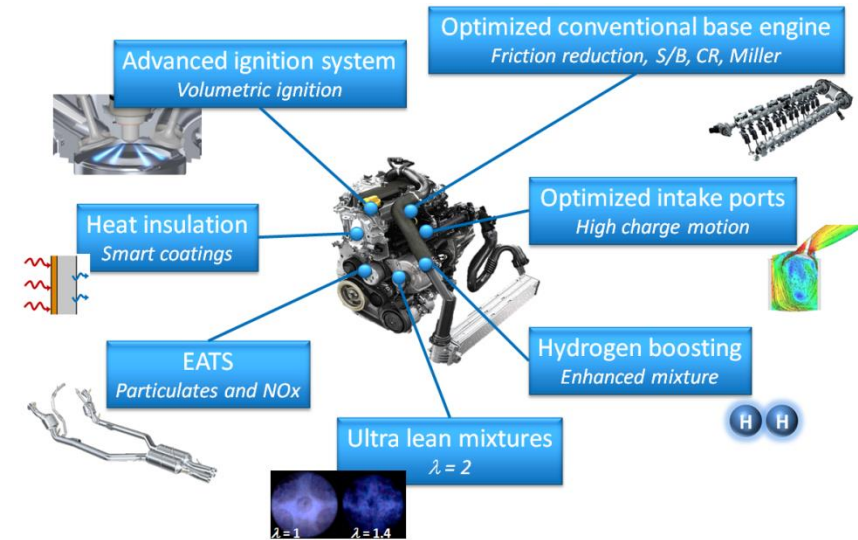
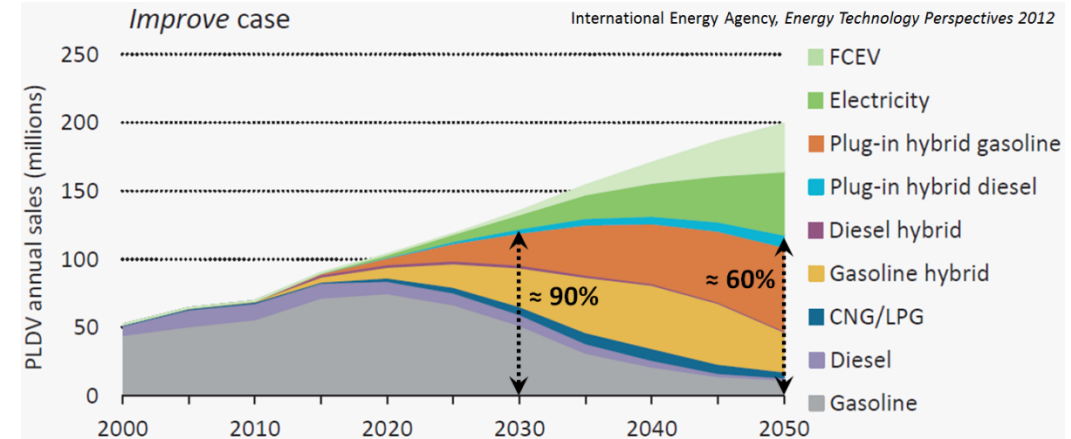

CONTENT

ITSC

- Concept
- Specifications
- Material screening & selection
- Coating system
- Testing / improvement
 - Testing rig
 - Test results
- Test sum-up
- Perspective



Energy losses in internal combustion engine

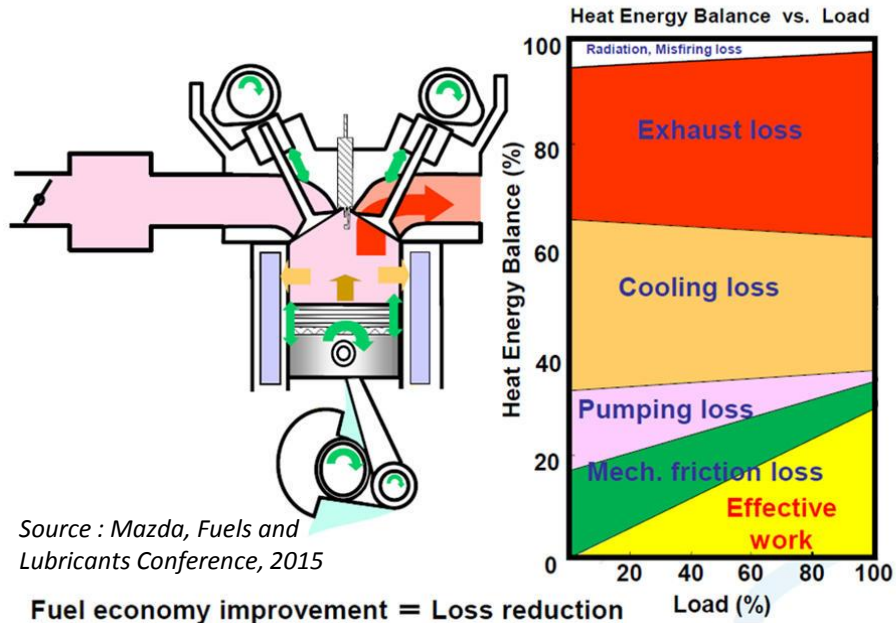

>30% of fuel energy is lost through heat energy transfer to cooling system

⇒ Heat transfer gas to wall

Heat

$$\Phi = \text{Area} \cdot \text{Convection Coefficient} \cdot (T_{Gas} - T_{Wall})$$

How can we reduce those cooling losses ?

- Adiabatic engine (tested in 80s~90s)
⇒ NOT THE SOLUTION : Too much downgrade of the combustion efficiency due to heat accumulation

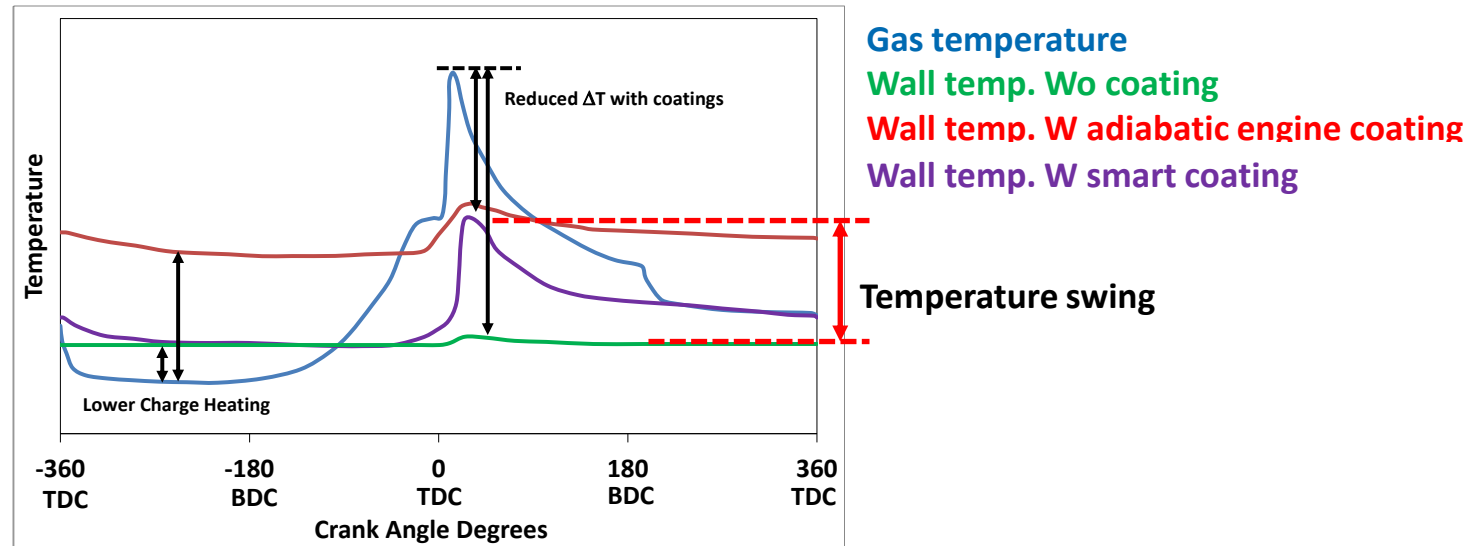

- Smart coating / thermo-swing coating
 - SOLUTION ? : Close match between wall and gas temperature during at every point of the combustion cycle

- Close match between wall and gas temperature during at every point of the combustion cycle

⇒ Insulation without heat accumulation

- Coating specifications
 - Low thermal conductivity
 - Low volumetric heat capacity
 - Density ; specific heat capacity ; porosity
 - Low volume => low thickness
 - Around 100 μ m
 - High mechanical strength at medium temperature
 - Thermal cycling = 10-40 Hz

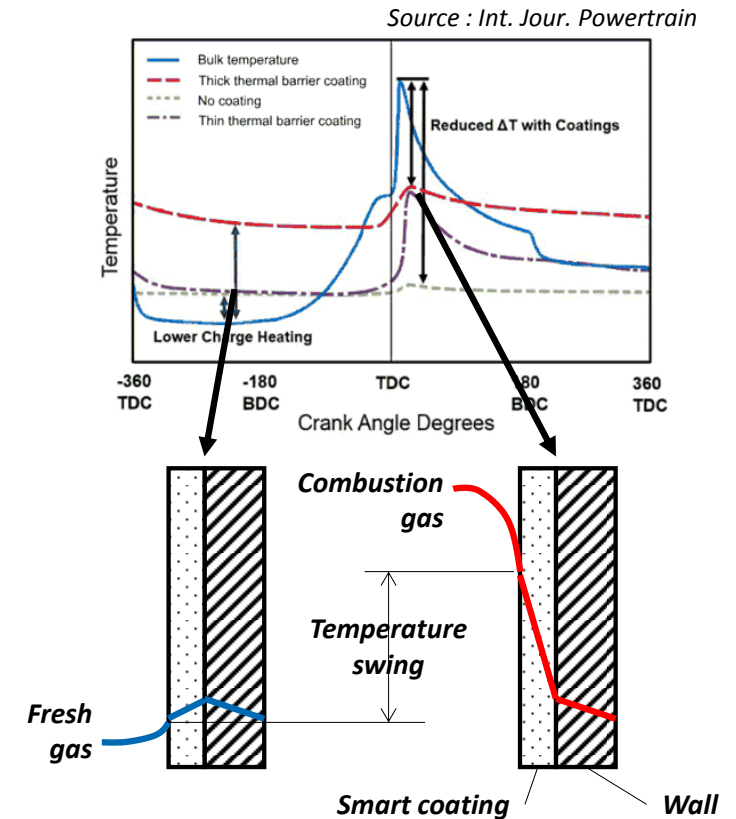

Material screening from literature

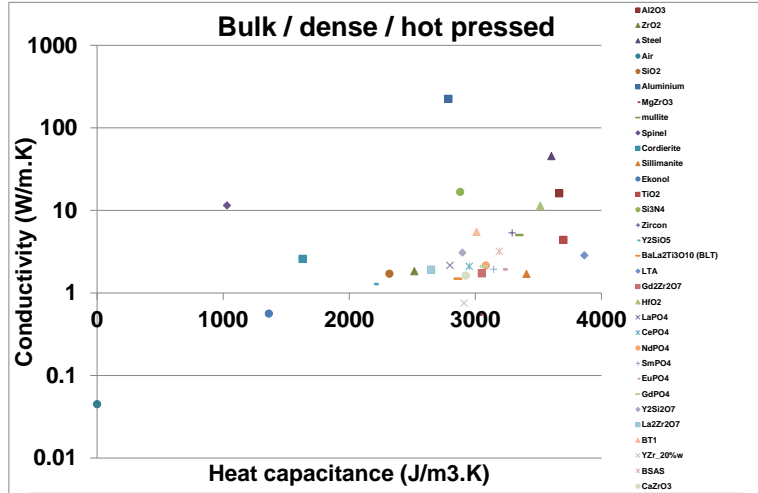

Use of Hashin-Shtrikman model to estimate properties as porous

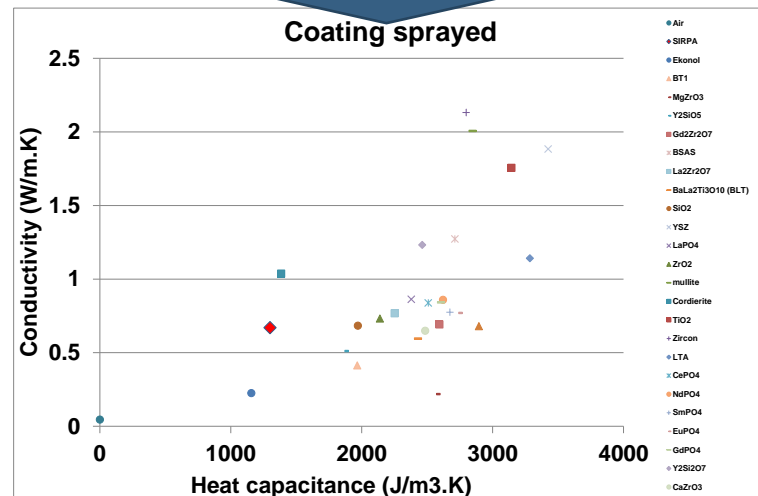

Material selection criteria : better than materials which show positive impact in literature ($<1.5 \text{ W.m}^{-1}.\text{K}^{-1}$; $<3500 \text{ kJ.m}^{-3}.\text{K}^{-1}$)



Selection:

- ⇒ Ceramic oxide
 - ⇒ Zirconate (MgZr, LaZr, GdZr)
 - ⇒ Silicate (BSAS, YMS)
- ⇒ Quasicrystal
 - ⇒ Cristome® BT1
- ⇒ Polymer
 - ⇒ Ekonol®

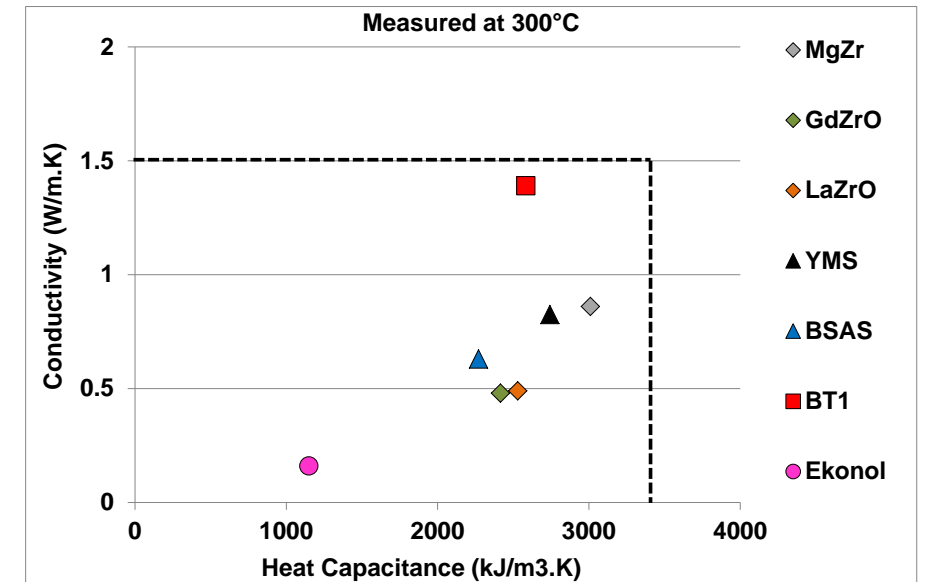

COATING SYSTEM

- High mechanical strength at medium temperature
 - Avoid brittle behavior
 - Avoid CTE mismatch

⇒ Composite of different nature of materials

- Ceramic oxide / Polymer
- Quasicrystal / Ceramic oxide
- Polymer /Quasicrystal

- Thermal properties
 - Inside our target $<1.5 \text{ W.m}^{-1}.\text{K}^{-1}$; $<3500 \text{ kJ.m}^{-3}.\text{K}^{-1}$

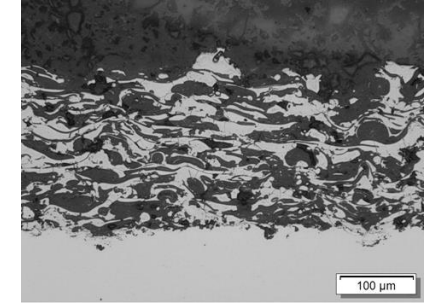

Selection of two coating materials

- Ceramic oxide (YMS) + Quasicrystal (BT1®)
 - Assumption good matching with substrate
- Ceramic oxide (BSAS) + Polymer (EkonoI®)
 - Best tradeoff

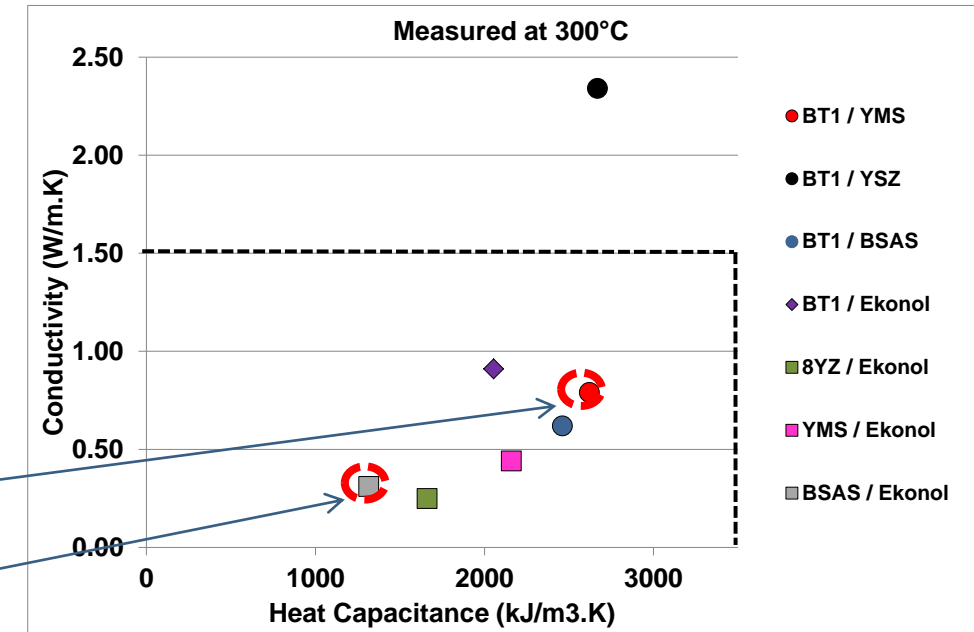

APPLICATION TEST / OUTCOMES

- Test of insulation coatings on single cylinder engines

Metal single cylinder engine



Optical single cylinder engine

Thermodynamic performance

Temperature swing measurements using LIP
(Laser Induced Phosphorescence)

Aluminum piston
Operating condition:
3000rpm-7bar IMEP

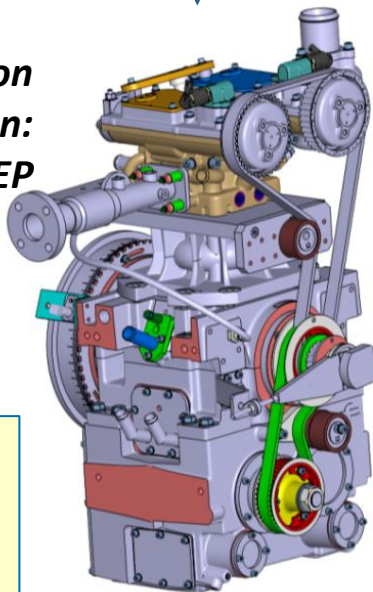

Similar properties
Stroke, bore, CR, ...

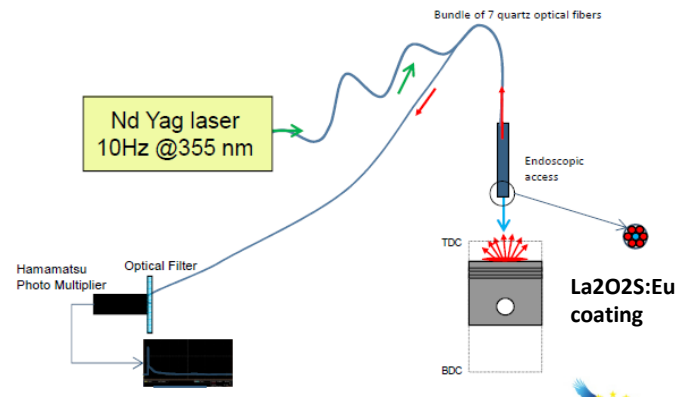
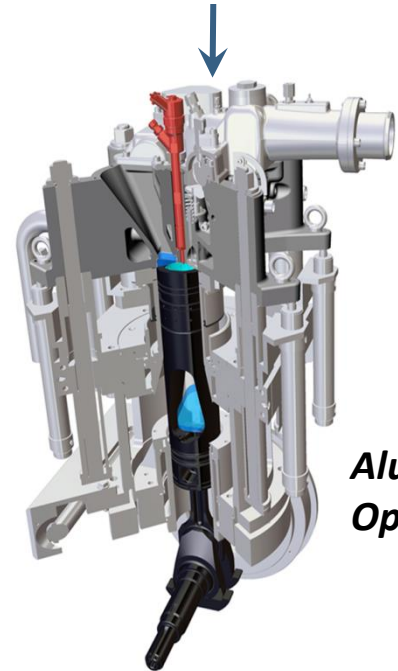

Aluminum & steel piston
Operating condition: 2000rpm-4bar IMEP

⇒ Piston surface temperature

Lean gasoline engine
 λ = ratio between the actual air-fuel ratio and the stoichiometric air-fuel ratio

- ⇒ Fuel consumption
- ⇒ Combustion behavior
- ⇒ Gas emissions

BASE LINE : SINGLE LAYER

- 2 first coatings tested : Coating #A & #C
- Main drawback measured
 - Unburned hydrocarbon emissions increase by 15~20%
- Assumption impact of roughness and/or open porosity

Name	Coating #A	Coating #C
Nature	Single layer - Quasi crystal / ceramic oxide composite	Single layer - Polymer / ceramic oxide composite
Thickness [μm]	Piston: 126 +/- 7	Piston: 104 +/- 7
Porosity [%]	10	26
Roughness - Ra [μm]	8	10

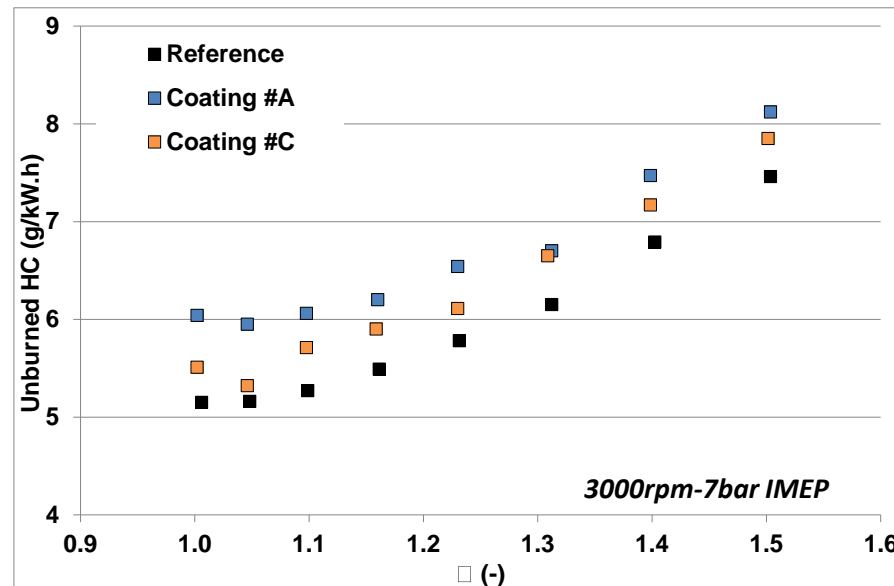

Unburned hydrocarbon emissions to be reduced

⇒ Fuel trapped in

⇒ Roughness ?

⇒ Open porosity ?

IMPROVE COATING SYSTEM : TOP LAYER

- Discriminate effect of porosity and roughness
 - Uncoated piston with equivalent roughness as coating designed and tested
 - Double layer with dense top layer :
 - Polymer / Ceramic oxide + dense Ceramic oxide layer (results not shown)
 - Quasicrystal /Ceramic oxide + sealing layer

Name	Coating #A	Coating #B	Coating #C	Rough piston
Nature	Single layer - Quasi crystal / ceramic oxide composite	Double layer - Quasi crystal / ceramic oxide composite - Sealing layer on top	Single layer - Polymer / ceramic oxide composite	Un-coated
Thickness [μm]	Piston: 126	Piston: 160	Piston: 104	-
Porosity [%]	10	10 (bottom layer) 0 (top layer)	26	"0"
Roughness – Ra [μm]	8	1	10	9

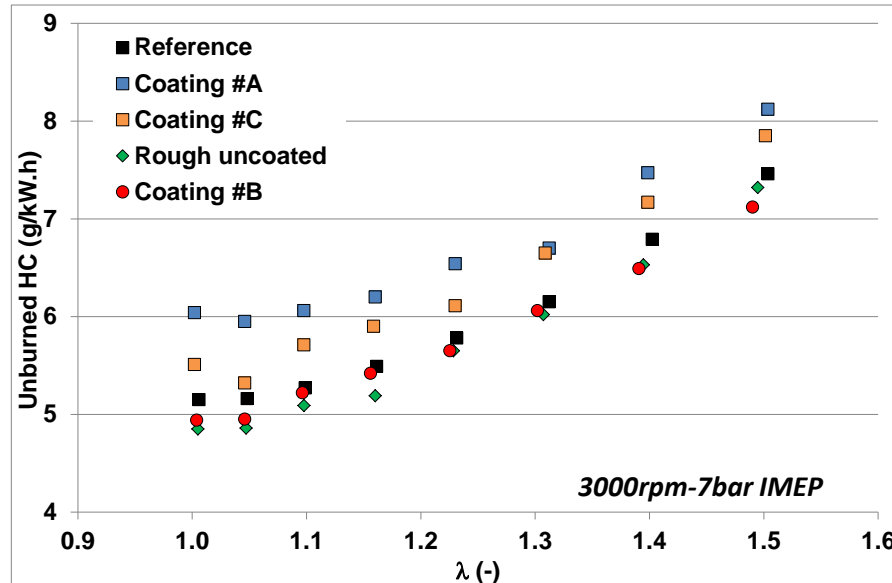

No increase of Unburned HC with dense layer and rough uncoated piston
 ⇒ **Open porosity to be reduced**

THERMODYNAMIC PERFORMANCE AND TEMPERATURE SWING

● Properties of coating tested on single cylinder engines

Name	Coating #A	Coating #B	Coating #C	Coating #D	Coating #E
Nature	Single layer - Quasi crystal / ceramic oxide composite	Double layer - Quasi crystal / ceramic oxide composite - Sealing layer on top	Single layer - Polymer / ceramic oxide composite	Double layer - Polymer / ceramic oxide composite - Dense ceramic oxide on top	Triple layer - Quasi crystal / ceramic oxide composite - Dense ceramic oxide layer - Sealing layer on top
Schematic					
Thickness on parts for metal engine [μm]	Piston: 126+/- 7	Piston: 160+/- N.A.	Piston: 104+/- 7	-	Piston: 207+/- 20 Cyl. head: 154+/- 20
Thickness on parts for optical engine [μm]	Piston: 158 +/- 8	-	Piston: 126 +/- 10	Piston: 130 +/- N.A.	Piston: 133 +/- 8
Porosity [%]	10	10 (bottom layer) 0 (top layer)	26	26 (bottom layer) 4 (top layer)	10 (bottom layer) 4 (middle layer) 0 (top layer)
Roughness – Ra [μm]	8	1	10	5	2
Conductivity [W.m-1.K-1]	0.79	0.88	0.38	0.46	0.85
Heat capacitance [kJ.m-3.K-1]	1600	2500	1200	1700	2600
Density	4.2	4.1	1.8	2.3	4.2

Several compositions (QC, CO, P) and structures (# layer and composite)

From 100 to 200μm

w/ & w/o open porosity on top layer

Low conductivity
Low heat capacitance



TEMPERATURE SWING

- Temperature swing (LIP) on Aluminum and Steel piston

Aluminum piston

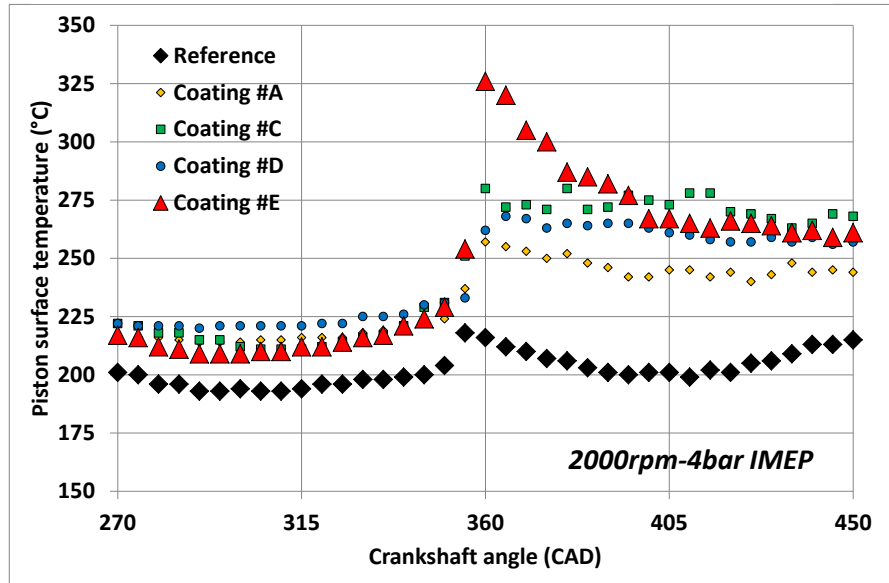

Steel piston

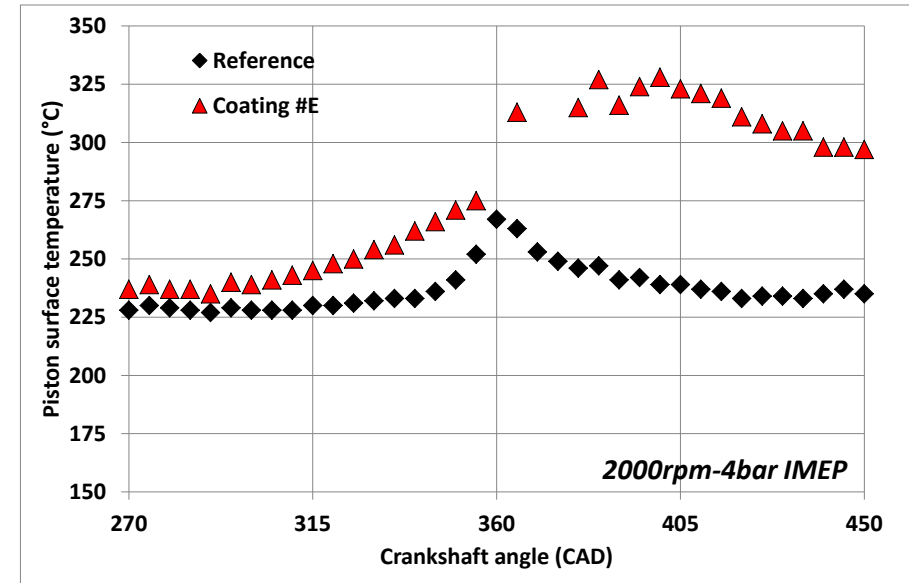

	2000 rpm – 4 bar IMEP	
	Aluminum	Steel
Reference: uncoated piston	20-30°C	35-40°C
Reference + coating #A	40-55°C	Not measured
Reference + coating #C	55-65°C	Not measured
Reference + coating #D	60-65°C	Not measured
Reference + coating #E	100-120°C	70-100°C

⇒ Temperature swing measured
 ⇒ Similar temperature swing with Steel and Aluminum piston

THERMODYNAMIC PERFORMANCE

- Combustion behavior : 2 criteria

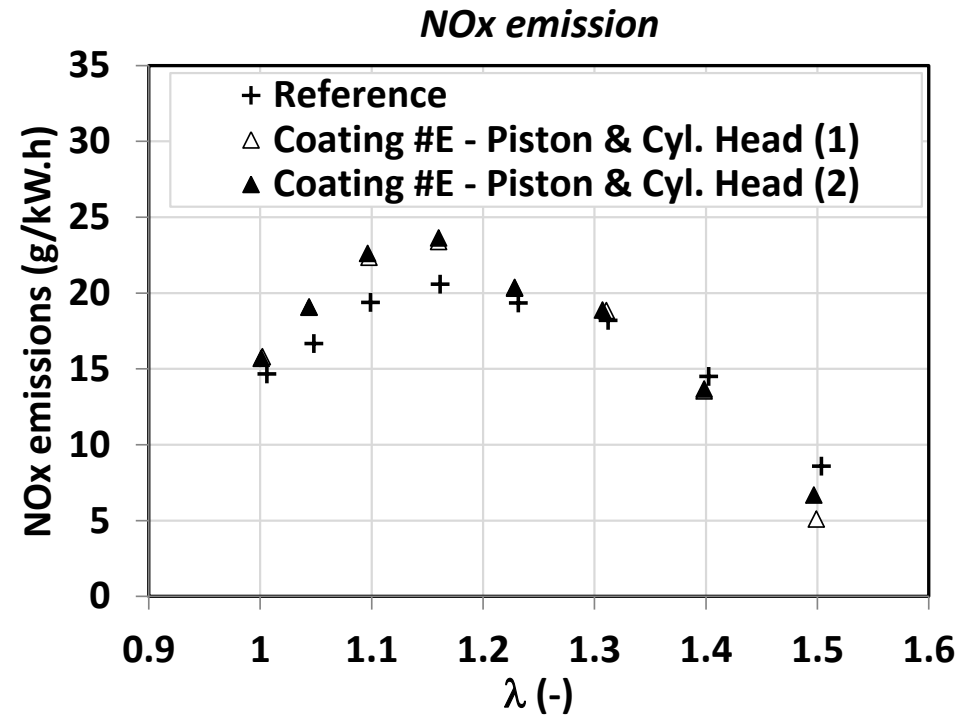
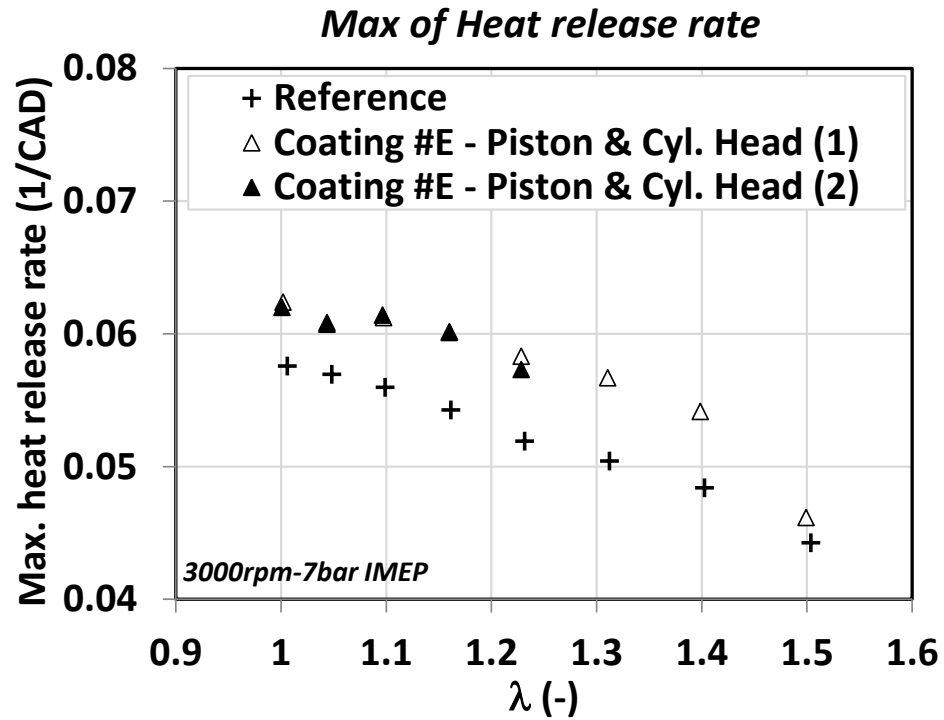

⇒ Higher combustion temperature

- RoHR shows the combustion (burning rate) speed
- NOx thermal formation process

Volumetric efficiency

$$Vol.Eff. = \frac{\text{Density of actual air fuel mixture}}{\text{Density of air fuel mixture at manifold condition}}$$

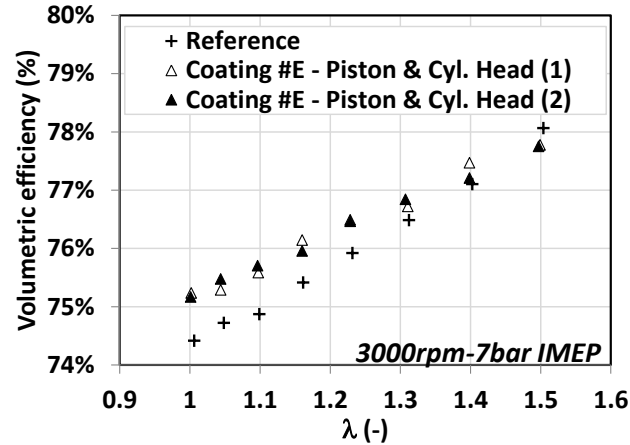

⇒ Slightly better intake efficiency : No increase of the fresh air temperature during the intake

- Consistent with surface temperature measurement
- Drawback of the adiabatic solve with smart coating

Global efficiency

Indicated efficiency

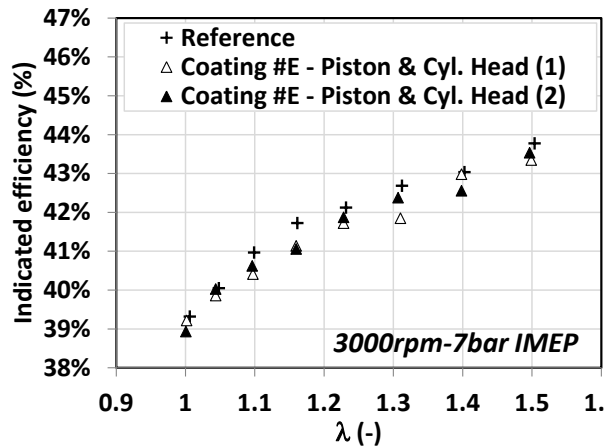

Combustion efficiency

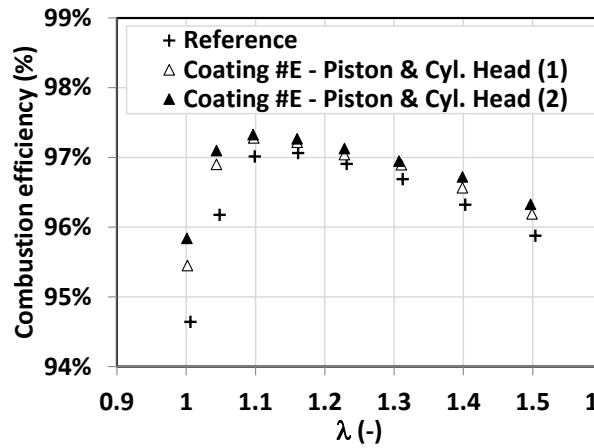

Cooling losses

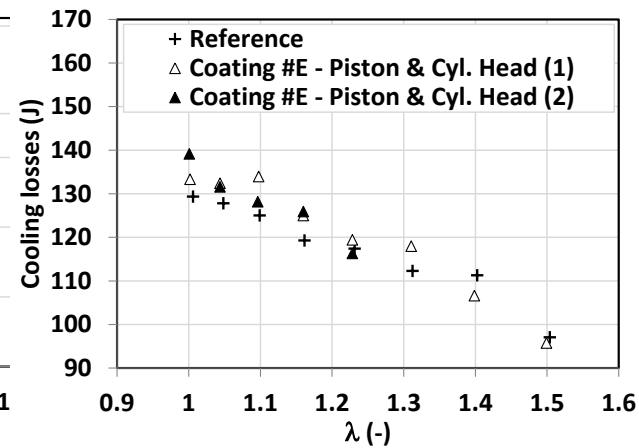

⇒ No gain using coating on efficiency / fuel consumption

⇒ Small increase (<1% increase) of cooling losses

EXPERIMENTAL TEST RESULTS SUM-UP

ITSC

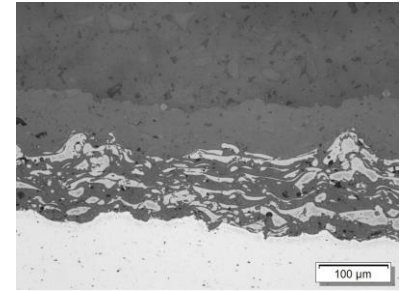

- Porosity
 - Open porosity lead to unburned HC
- Roughness
 - Piston surface roughness has no impact on unburned hydrocarbon emissions and on efficiency without any temperature swing (uncoated piston)
- Coating
 - Highest temperature swing (center piston) measured with coating #E
 - Measured on aluminum and results also obtained on steel piston
 - Higher combustion temperature with coating #E
 - Combustion speed increase and NOx emissions increase
 - No decrease of fuel consumption
 - Cooling losses inside the combustion chamber increased with coating #E
 - No increase of the fresh air temperature during the intake

Coating qualitatively reach the temperature swing objective

⇒ **Positive impact on combustion behavior seems showing insulation effect during combustion**

⇒ **Drawback seems to counterbalance this positive effect => still to be identified**

- Coating properties adjustment
 - Better understanding of the heat transfer physics
 - Thermal boundary layer investigation
 - Roughness
 - Radiative properties
 - Thermo-mechanical improvement
- Combination of the EAGLE breakthrough elements in the same engine
 - Combustion chamber design & Coating integration using alternative combustion systems
 - Refine coating location to avoid potential coating negative impact
 - Diffusion-like versus propagation flames
 - Combustion strategy
- End project Q1-2020

Efficient Additivated Gasoline Lean Engine



Find us on:

 www.h2020-eagle.eu

Contact: bernard.bouteiller@saint-gobain.com

Thank you for your attention



UNIVERSITAT
POLITÈCNICA
DE VALÈNCIA



UNIVERSITÀ DEGLI STUDI DI NAPOLI
FEDERICO II