



HAL
open science

Electrochemical study of oxygen impact on corrosion and hydrogen permeation of Armco iron in the presence of H₂S

Martien Duvall Deffo Ayagou, Jean Kittel, Thi Tuyet Mai Tran, Bernard Tribollet, Eliane Sutter, Nicolas Ferrando, Christophe Mendibide, Claude Duret-Thual

► **To cite this version:**

Martien Duvall Deffo Ayagou, Jean Kittel, Thi Tuyet Mai Tran, Bernard Tribollet, Eliane Sutter, et al.. Electrochemical study of oxygen impact on corrosion and hydrogen permeation of Armco iron in the presence of H₂S. Eurocorr 2018, Sep 2018, Cracow, Poland. hal-02462572

HAL Id: hal-02462572

<https://ifp.hal.science/hal-02462572>

Submitted on 31 Jan 2020

HAL is a multi-disciplinary open access archive for the deposit and dissemination of scientific research documents, whether they are published or not. The documents may come from teaching and research institutions in France or abroad, or from public or private research centers.

L'archive ouverte pluridisciplinaire **HAL**, est destinée au dépôt et à la diffusion de documents scientifiques de niveau recherche, publiés ou non, émanant des établissements d'enseignement et de recherche français ou étrangers, des laboratoires publics ou privés.

Electrochemical study of oxygen impact on corrosion and hydrogen permeation of Armco iron in the presence of H₂S

Martien Duvall Deffo Ayagou^{1,2}, Jean Kittel¹, Thi Tuyet Mai Tran³, Bernard Tribollet³, Eliane Sutter³, Nicolas Ferrando⁴, Christophe Mendibide², Claude Duret-Thual².

1- IFP Energies nouvelles, Rond-Point de l'échangeur de Solaize, BP3, 69360 Solaize, France

2- Institut de la Corrosion – Site de Saint-Etienne, zone d'activités du parc secteur Gampille 42490 Fraisses, France

3- Laboratoire Interfaces et Systèmes Electrochimiques (LISE), UMR 8235 CNRS-Sorbonne Université 75252 Paris Cedex 05, France

4- IFP Energies nouvelles 1 et 4 avenue de Bois-Préau 92852 Rueil-Malmaison, France.

Abstract

H₂S corrosion of mild steel is a recurrent issue in the oil and gas industry. Many studies related to the corrosion and hydrogen permeation of steel in an H₂S containing environment have been made during the past decades with the intent of improving the knowledge and the prevention of economic loss. Since H₂S is also a hydrogen entry promoter, lots of studies are also dedicated to the understanding of H₂S cracking. Although it is generally accepted to avoid oxygen contamination in such a medium, there is a lack of research concerning its effect on the corrosion and hydrogen charging of steel.

In this study, the effect of oxygen on corrosion and hydrogen charging of steels in an H₂S containing environment is studied using Electrochemical Impedance Spectroscopy (EIS). An equivalent electrical circuit has been built according to SEM observations, literature research and experimental results. Using this equivalent electrical circuit, experimental data was analyzed and the average corrosion rates were deduced and found to be in good agreement with corrosion rates obtained by weight loss measurements. Furthermore, the evolution of fitting parameters (double layer capacity, charge transfer resistance, diffusion impedance, etc.) was found to be in good agreement with the real physical meaning of such parameters in the given conditions. This research contributes to the explanation of the mechanism behind the high corrosion rate observed in an H₂S environment polluted with traces of oxygen.

keywords : H₂S, EIS, corrosion, Oxygen

Introduction

Corrosion of metallic materials in the oil and gas industry has been and remains a major concern in recent decades, with significant financial and environmental implications. Notwithstanding the development of corrosion-resistant alloys, their high cost dictates the predominant use of carbon steel in the oil and gas industry, despite its average resistance to corrosion. CO_2 and H_2S are the main corrosive agents always present in varying proportions in oil and gas environments. Metallic materials in use in these environments, are therefore generally subjected to an acid medium containing H_2S which increases the risk of cracking. Fortunately, oil and gas industries have a strong experience in the corrosion and cracking of low alloyed steels in acidic medium containing H_2S . However, this important industrial experience is almost exclusively concerned with oxygen-free environments, since oil and gas environments are generally anoxic. However, the remarkable evolution of new techniques and methods of oil production as the enhanced oil recovery (EOR), in which a fluid is injected into the well to optimize the extraction of crude oil can introduce oxygen into these media, since complete deaeration of the fluid is not guaranteed. Oxygen pollution may also be encountered in laboratory environments used for the qualification of steel resistance to H_2S cracking, with potential impact on test results. Indeed, the presence of oxygen in these H_2S -containing media could modify the solution chemistry, the mechanisms and nature of the corrosion deposits, and the hydrogen charging intensity. Electrochemical impedance spectroscopy (EIS) represents an interesting technique to study the evolution with time of corrosion reaction, as it is usually performed at the corrosion potential. Many EIS studies of CO_2 and H_2S corrosion, conducted at ambient temperature and in NaCl solutions saturated with CO_2 and/or H_2S are available in the literature [1–4]. Compared to CO_2 , electrochemical measurements in H_2S environments seem to be much more difficult, and the shape of impedance diagrams vary a lot between various studies.

Generally, two different impedance shapes are presented in available literature on H_2S corrosion of low alloy steels. The first type of results shows a high frequency (HF) behavior dominated by the anodic charge transfer resistance and the double layer capacitance, while low frequency characteristics correspond to relaxation of adsorbed species (Figure 1.a and Figure 1.b). This type of result was obtained for short immersion times, and it was mentioned that no surface precipitation was visible after the tests. Indeed, these tests were performed at low pH or in presence of acetate, which retards iron sulfide precipitation. In that case, impedance response is mainly dominated by anodic reactions.

The second type of result shows a different behavior, with a 45° tail at low frequency (LF), interpreted by diffusion limitation (Figure 1.c). In that case, presence of iron sulfide scale was observed. In addition, impedance measurements were performed at short immersion time

and then repeated after 24 hours, and a significant increase of the high frequency semi-circle (interpreted as R_t) was observed, and was associated with a decrease of the corrosion rate.

a)

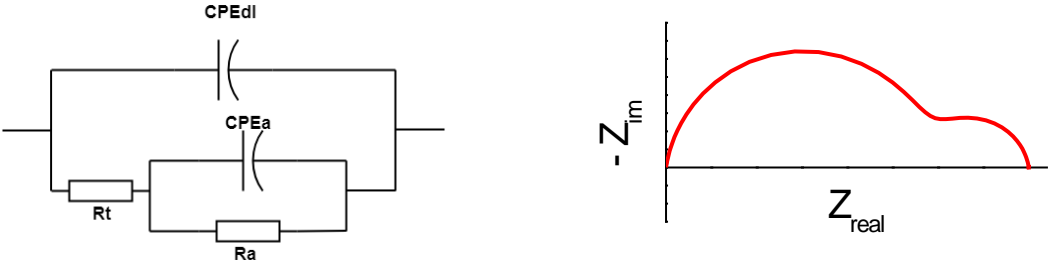

b)

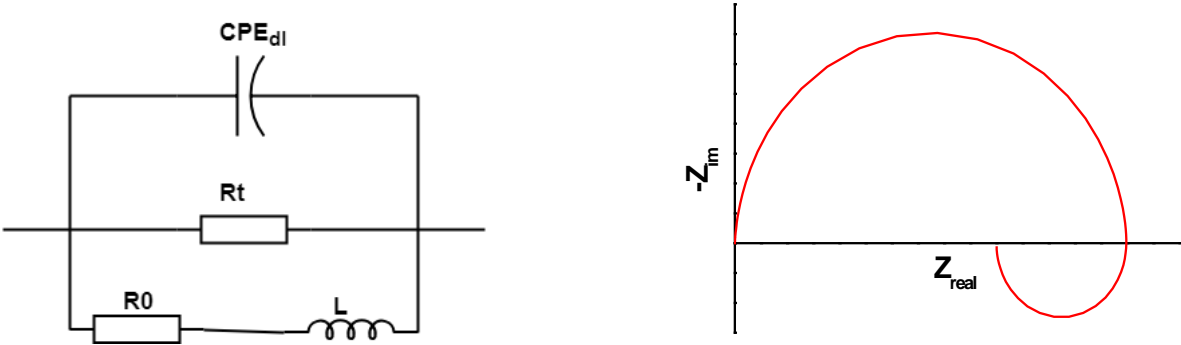

c)

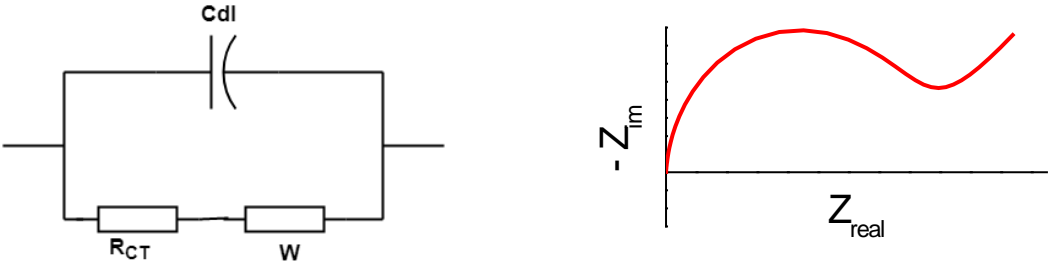

Figure 1: Equivalent circuits and corresponding impedance diagram used in the literature to describe iron corrosion in presence of H_2S [3,5,6]. For the sake of simplicity, electrolyte resistance was removed from these equivalent circuits.

The first aim of this paper is thus to examine the evolution with time of EIS spectra of pure iron exposed to water containing dissolved H_2S and eventually dissolved O_2 . Contrary to what already exists in the literature, time evolution over a few weeks will be examined, allowing significant iron sulfide precipitation and/or oxides deposits. This time-scale is

representative of sulfide stress cracking (SSC) qualification tests as per NACE TM0177, which constitute one field of application of this project [7]. The effect of oxygen on corrosion mechanisms, and hydrogen charging efficiency all over the exposure time will also be examined.

Experimental procedure

This study is part of a project which main objective is to study the impact of oxygen pollution on hydrogen charging. Hydrogen permeation is thus used as the central experimental method, together with EIS measurements. The experimental set-up thus consists in a Devanathan-Stachurski system shown in Figure 2 [8]. The apparatus is composed of twin cells separated by the iron membrane. The cells are equipped with double jacket in order to maintain the temperature at $24 \pm 2^\circ\text{C}$.

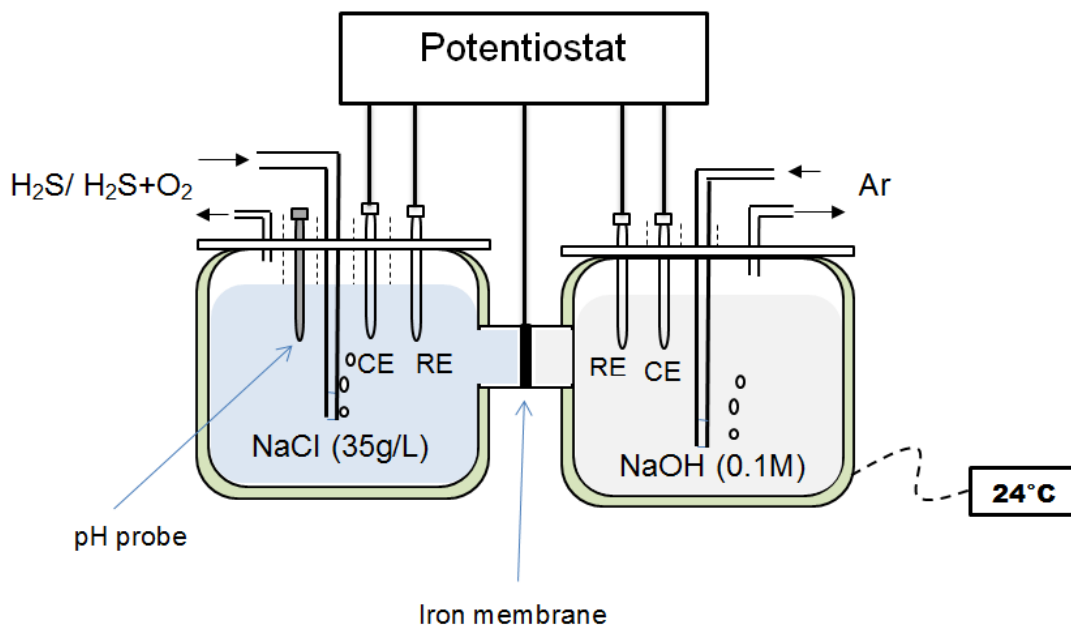

Figure 2: Experimental set up (Devanathan-Stachurski type cell).

In this experimental system, test specimens consisted in pure iron membranes, annealed under vacuum at 900°C for 30 minutes (chemical composition provided in Table 1). These membranes were thus exposed on one side to the corrosive environment containing H_2S where EIS measurements were made (designated as charging side), while the other side was exposed to 0.1 M sodium hydroxide and maintained at an anodic potential of 250 mV vs. Hg/HgO (1M KOH) for hydrogen permeation measurement (designated as detection side). The exit face was covered by palladium following well established procedures [9]. Membrane thickness was in the order of 0.5 mm, and the exposed area was 17 cm^2 on both sides.

Details on hydrogen permeation measurement procedure were given in a previous paper [10].

Table 1: Chemical composition of test material (mass. ppm)

Al	Cr	Cu	Mn	Ni	Si	Ti	C	P	S	Fe
107	133	55	240	159	100	5	18	60	48	Bal

EIS measurements were carried out with the iron membrane as working electrode, an Ag/AgCl reference electrode and a platinum mesh as auxiliary electrode. A perturbation of +/- 10 mV amplitude around the corrosion potential was applied with a range of frequency of 10 kHz to 1 mHz. Each EIS measurement was preceded by an open circuit potential (OCP) measurement of about 2 hours. OCP and EIS measurements were then repeated over 3 weeks. Specific precautions were taken to avoid interferences between electrochemical measurements performed simultaneously on both sides of the membrane.

In addition to the permeation membrane, pure iron flat specimens (0.9 cm x 0.9 cm x 0.05 cm) were also introduced into the charging side. These coupons were used for weight-loss corrosion rate evaluation, as well as surface analysis by scanning electronic microscopy (SEM) and X-ray diffraction (XRD). The total surface of iron specimens exposed in the charging side was thus close to 23 cm², while the volume of test solution was 0.6 L.

Test solution at the entry side consisted in 35 g/L NaCl dissolved in distilled water. Continuous bubbling of H₂S/N₂ (10%) and eventually O₂ /N₂ (10%) corresponding to 13 mbar oxygen partial pressure, was maintained during all experiments. The resulting H₂S concentration was around 0.01 M, and an initial pH around 4.4 – 4.7 for test without oxygen. For the tests with O₂ pollution at a partial pressure of 13 mbar, the resulting dissolved O₂ concentration at equilibrium was close to 500 ppb mass.

Results

Since one main goal of this study is to evaluate the evolution of H₂S corrosion over a few weeks, changes in the test solution are likely to occur. Indeed, as iron corrosion proceeded, alkalinity is released by the cathodic reaction (reduction of protons and H₂S). It results in pH increase, until iron sulfide saturation is reached. As shown on Figure 3, initial pH is 4.8 close to pH of water saturated with 0.1 bar H₂S. After a few hours, a plateau was reached around pH 5 – 5.1, corresponding to FeS saturation. No changes were further observed for the test without oxygen. On the contrary for the test treated with continuous O₂ pollution, a

continuous decrease of pH is observed, from 5.1 after a few days and down to 4.5 after 3 weeks exposure.

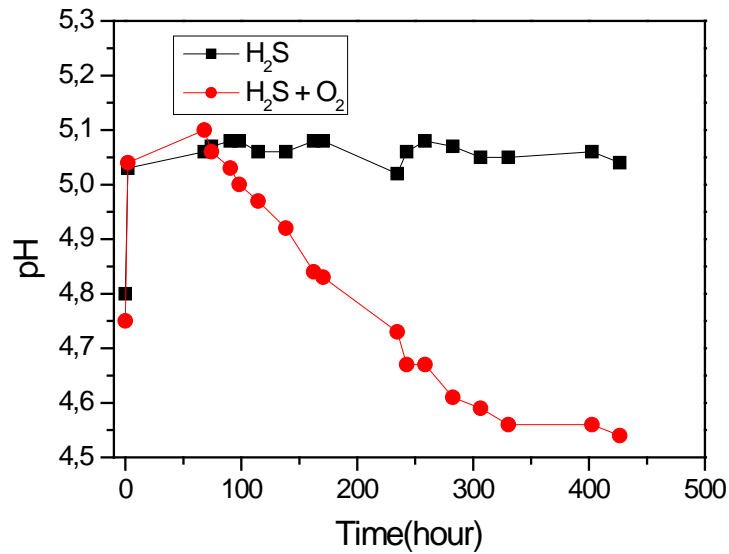

Figure 3: pH evolution of test solution consisting of 35 g/L NaCl solution saturated with H₂S/N₂ (10%) with and without continuous O₂ pollution at 24°C, with iron coupons exposed to corrosion.

Typical evolution with time of exposure of Nyquist diagrams are presented in Figure 4 for tests with and without oxygen. In both case for short exposure times, Nyquist diagrams consist of a capacitive loop at high and medium frequencies, and a LF contribution which could correspond to a 45° linear tail or to the start of a second capacitive loop with a very low characteristic frequency. They have the same shape as Nyquist diagrams obtained in pure H₂S and presented in a previous work [4]. Throughout all exposure period, the corrosion potential varied in a narrow range, between -700 and -720 mV vs. Ag/AgCl, for the test without oxygen and between - 640 and -720 for the test in presence of O₂. These impedance diagrams are similar to those obtained by Arzola et al. [3]. In addition, and as observed for the previous work, the diameter of the capacitive loop increases with time. The main difference between both cases becomes apparent at long exposure times.

At longer immersion times, some overlap between the HF capacitive loop and the LF contribution occurs for the test without oxygen. It becomes difficult to distinguish the various contributions to the impedance, which seems to be flattened and to tend towards a single line inclined at 45°. In presence of oxygen at longer immersion time, the LF 45° tail disappears, and only a capacitive loop is observed.

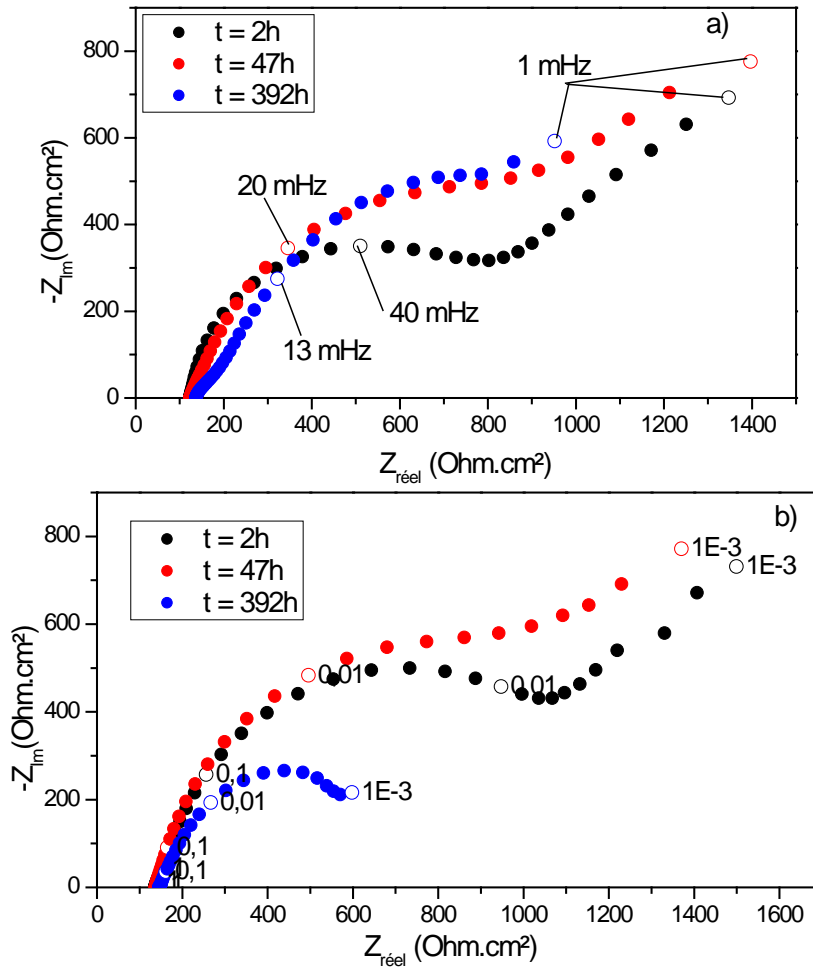

Figure 4: Nyquist diagrams of pure iron in NaCl 35g/L saturated with H₂S/N₂ (10%), at different exposure times a) without O₂ b) with O₂.

EIS analysis required to develop a specific model, with all details given in a previous paper [4]. This model takes into account the build-up of the highly porous and conductive iron sulfide layer, represented by Z_{film} . This conductive film behaves as a porous electrode, and it has a strong impact on the total impedance. Due to a distribution of pore sizes, the impedance of this film presents a dual behavior with two parallel contributions: i/ the first one corresponding to a plane electrode (Equation 1) and, ii/ the second one corresponding to a porous electrode (Equation 2). In these expressions, Z_{eq} defines the interfacial impedance at the surface of the conductive film inside the pores, and n , r and l are respectively the number of pores, their radius and length. The square root term of the porous electrode contribution explains the 45° inclination of the impedance at long exposure times observed in pure H₂S/N₂ (10%) without O₂ pollution. The resulting equivalent circuit is given in Figure 5, where Z_{film} corresponds to the contribution of the corrosion product scale given by Equation 3, R_t is the charge transfer resistance associated with the double layer capacitance CPE_{dl} ,

and R_a and CPE_a are associated with the adsorption – desorption step of anodic dissolution. Constant phase elements (CPE's) were used instead of pure capacitance due to time constant distribution associated with surface heterogeneities. For short immersion times, when corrosion product scale is absent or still very thin, the contribution of Z_{film} is negligible, and the equivalent circuit is then similar to that used by Ma and co-workers in H_2S solutions at lower pH [11,12].

$$Z_{film,plane} = Z_{pore} / n = Z_{eq} / 2n\pi f \quad \text{Equation 1}$$

$$Z_{film,porous} = \sqrt{\rho Z_{eq}} / \sqrt{2n\pi f}^{3/2} \quad \text{Equation 2}$$

$$Z_{film}^{-1} = Z_{film,plane}^{-1} + Z_{film,porous}^{-1} \quad \text{Equation 3}$$

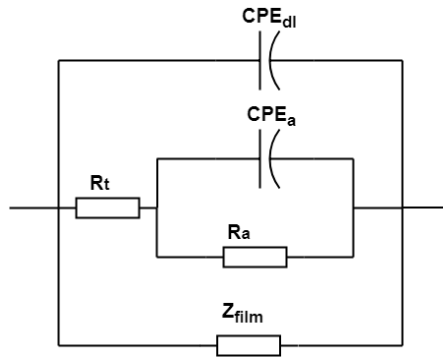

Figure 5 : Equivalent circuit for the corrosion of pure iron in H_2S containing environment with the formation of a conductive and porous FeS layer.

All EIS spectra were analyzed with this equivalent circuit. A good correlation were obtained in both condition (with and without oxygen) between adjusted impedance diagrams and experimental diagrams (Figure 6).

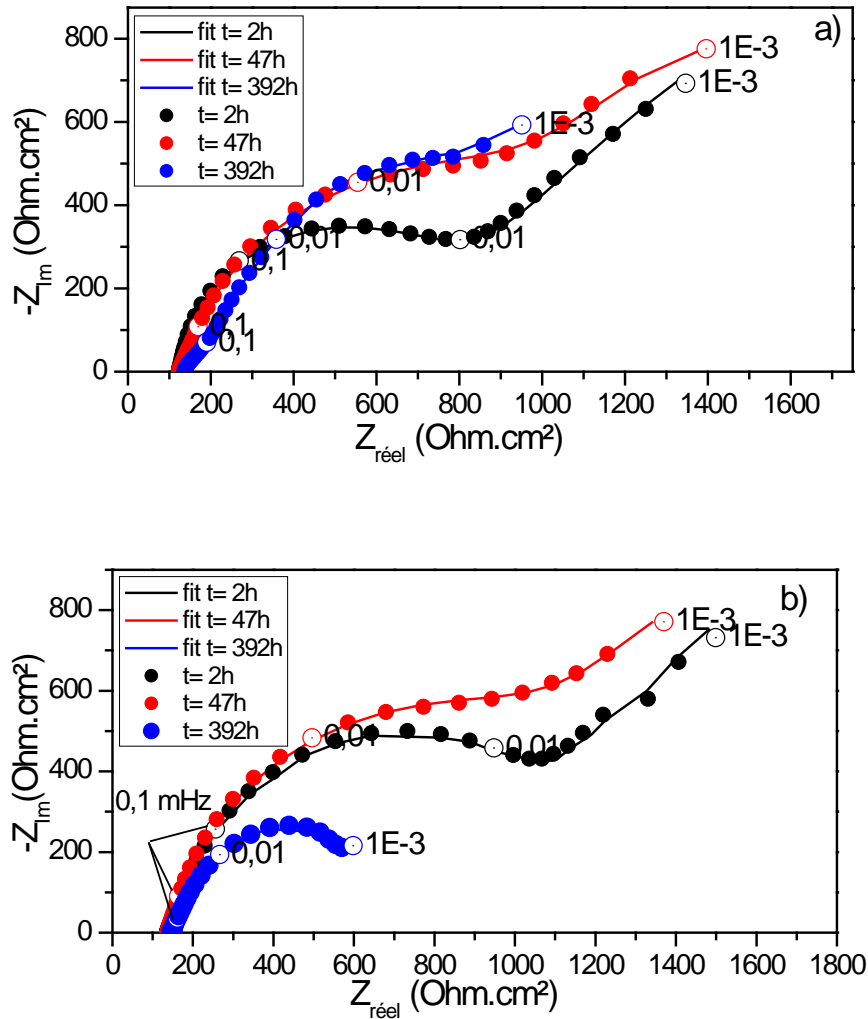

Figure 6: Comparisons between experimental (symbols) and fitted impedance (lines) measured in NaCl 35g/L solution saturated with H₂S/N₂ 10% without O₂ (a) and with O₂ (b)

From EIS analysis, corrosion current densities (J_{corr}) were calculated from R_t using the Stern and Geary relationship with an anodic tafel coefficient (b_a) of 40 mV, as usually observed in H₂S environments [13]:

$$J_{corr} = b_a / 2.3R_t \quad \text{Equation 4}$$

Evolution of corrosion current densities with exposure time are compared in Figure 7, for the experiments conducted with and without O₂ pollution. The acceleration of corrosion rates by O₂ pollution is confirmed. It is shown that the acceleration is not immediate. During the first days, corrosion rates are similar in both experiments, starting close to 0.4 – 0.35 mm/year, and quickly decreasing to 0.25 – 0.2 mm/year after 1 or 2 days. However, while corrosion rate remained stable for the remaining 3 weeks in the test without oxygen, it started to increase after approximately 150 hours in presence of O₂ pollution. At the end of the test, the

corrosion rate was close to 0.65 mm/year. This increase is well correlated with pH evolution (Figure 3). For both tests, an excellent agreement was found between the average corrosion rate calculated from electrochemical measurements (respectively 240 $\mu\text{m}/\text{year}$ and 400 $\mu\text{m}/\text{year}$ without or with O_2 pollution) and weight-loss measurements (respectively 280 $\mu\text{m}/\text{year}$ and 500 $\mu\text{m}/\text{year}$ without or with O_2 pollution).

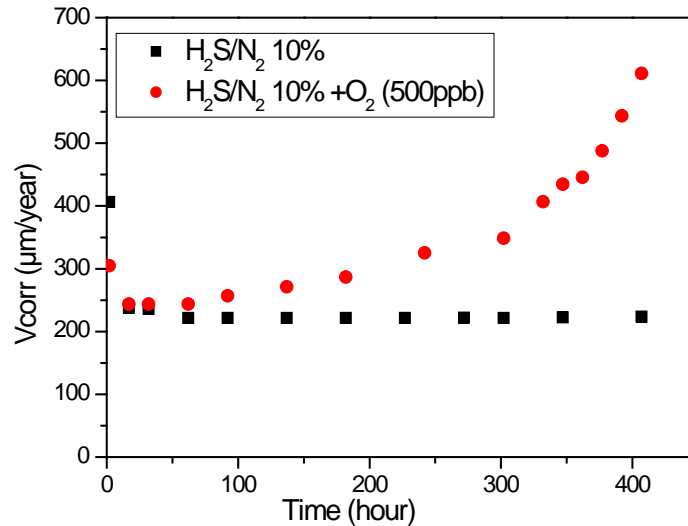

Figure 7: Evolution with time of corrosion rate determined by EIS fitting with the model of Figure 5 for tests with and without O_2 .

The evolution with time of the capacity for both test conditions is also presented in Figure 8. Not surprisingly, a gradual increase in capacity for both test conditions is observed. This increase in capacity can be related to the development of the iron sulfide layer. On the other hand, we do not observe an abrupt break in the capacity curve as it was the case for the tests under 1 bar of H_2S in our previous works [4]. Two hypotheses can be suggested to explain this continuous increase of capacity: either the deposit is more adherent under low H_2S content, or the formation of the deposit is slower, therefore the internal stress of the deposit for the considered exposure time, is not enough to cause it to break. This last hypothesis seems more plausible. It can be remarked that the porous and conductive film represents a major contributor to the capacitance, since double layer capacitance for a metal electrode in aqueous solution is usually close to 100 $\mu\text{F}/\text{cm}^2$, i.e. 400 to 500 times less than observed values [14].

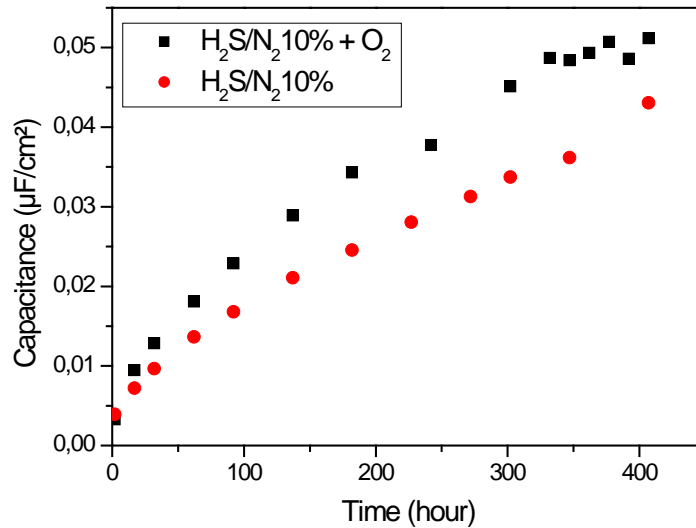

Figure 8: Evolution with time of the capacitance determined by EIS fitting

Impact of O₂ on hydrogen permeation

The effects of oxygen on permeation through a pure iron membrane in NaCl saturated solution with H₂S/N₂ (10%) with and without O₂ are illustrated in Figure 9. No particular effect of oxygen is observed on the permeation. However, the permeation current density is lower in the presence of oxygen compared to the permeation density current for the test without O₂.

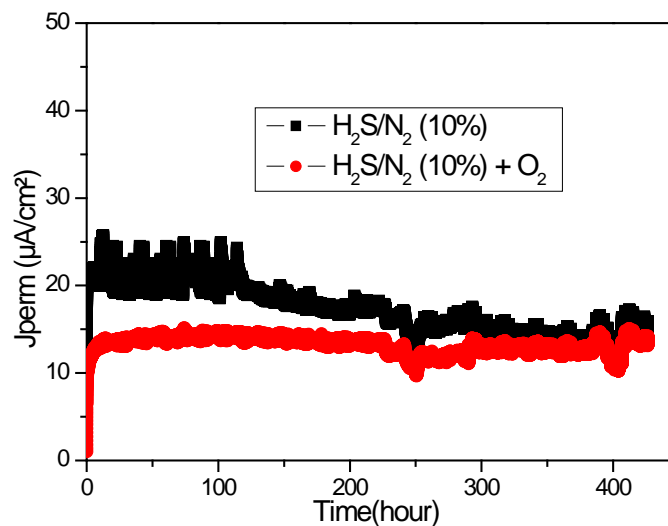

Figure 9: Permeation curves in 35 g/L NaCl under H₂S/N₂ 10%, with and without oxygen.

Thanks to the impedance measurements, time evolution of corrosion current densities is available (Figure 7), and could be compared to hydrogen permeation rates. This comparison

is presented in Figure 10. For both tests, the permeation efficiency (E_{perm}) was also plotted. This parameter is calculated from the ratio between the permeation current density and the corrosion current density, expressed in %. For the test conducted without O_2 , as observed in some previous work under 1 bar H_2S , there is equality between the corrosion current density and the hydrogen permeation current density (Figure 10). This result is a clear evidence that the cathodic reaction involved in H_2S/N_2 (10%) systems consists only of proton reduction, and also that the permeation efficiency is close to 100%, meaning that 100% of hydrogen produced by the cathodic reaction has entered into the steel. This type of behavior is typical in such systems, provided that no hydrogen diffusion limitation in the metal takes place, which requires that the membrane thickness is sufficiently thin [15–17]. On the contrary, for the tests with O_2 pollution, a clear deviation between corrosion and permeation rates appeared after a few days (Figure 10). While the permeation efficiency was close to 70% at the beginning of the test, it had decreased down to 20% after 21 days.

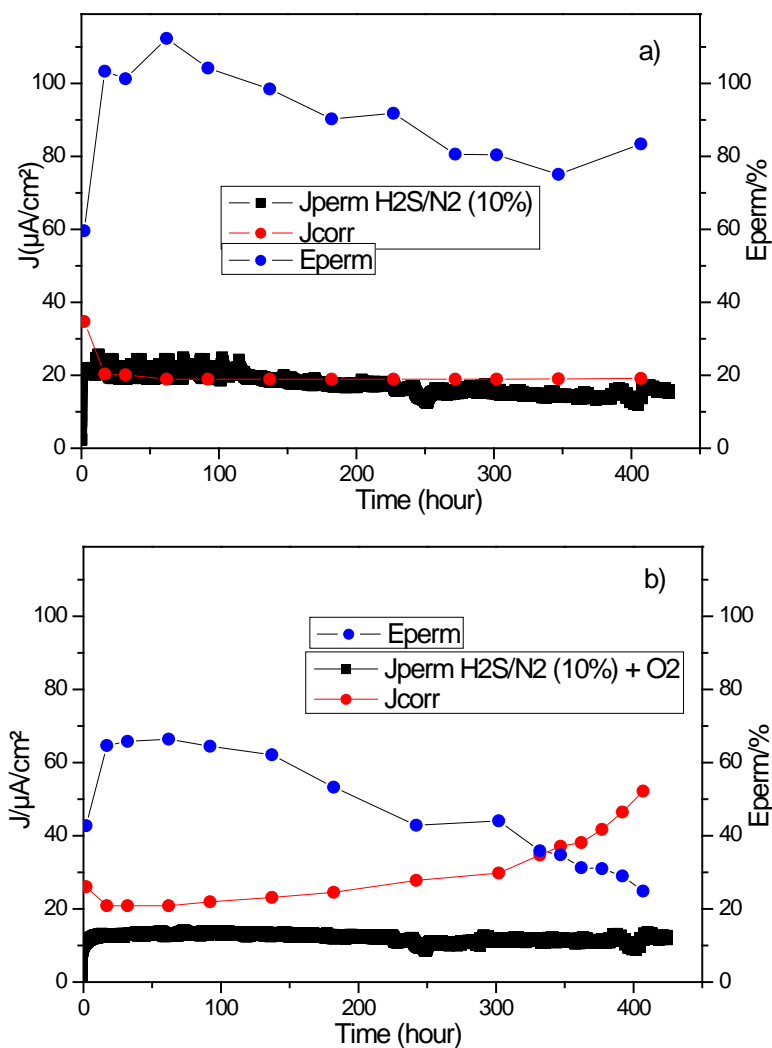

Figure 10: Comparisons between J_{corr} and J_{perm} and evolution with time of the permeation efficiency, for the test without O_2 pollution (a) and for the test with O_2 pollution (b)

Several hypothesis can be proposed to explain this decrease of hydrogen permeation efficiency. New electrochemical reactions, associated with reaction products between O_2 and H_2S , might participate in the cathodic current, without leading to hydrogen entry. Another hypothesis could involve changes at the metal surface resulting in a decrease of hydrogen entry promotion.

Conclusion

Corrosion of pure iron in $\text{H}_2\text{S}/\text{N}_2$ (10%) with and without O_2 , saturated 35g/L NaCl solution was studied for 3 weeks. As expected, we observed that oxygen has a strong influence on the test solution composition, and consequently on the corrosion rates. Indeed, the corrosion rate is twice higher in the solution treated with simultaneously H_2S and O_2 compared to the corrosion rate in the solution without O_2 .

An impedance model developed in previous work and consisting in a faradaic anodic impedance made of a two-step reaction with charge transfer and adsorption – desorption, and an additional contribution, associated with the conductive and highly porous iron sulfide film was used. We observed a good correlation between experimental and fitted impedance diagrams. The corrosion rates deduced from EIS measurements analysis are in good agreement with corrosion rates obtained by weight loss measurements.

The permeation efficiency for the test without O_2 is close to 100% as expected, since the system presents an efficient hydrogen entry promoter. For the test with oxygen pollution, the permeation efficiency decrease with time, down to 20% after 3 weeks exposure, while corrosion rate increased due to the test solution acidification.

In the future works we would like to perform some test in buffered solutions with steel grades used for oil and gas production, in order to obtain more direct comparison of NACE standard test conditions (as per NACE TM 0284 or NACE TM0177).

References.

- [1] H. Ma, X. Cheng, G. Li, S. Chen, Z. Quan, S. Zhao, L. Niu, *Corrosion Science* 42 (2000) 1669–1683.
- [2] H.Y. Ma, X.L. Cheng, S.H. Chen, G.Q. Li, X. Chen, S.B. Lei, and H.Q. Yang, *Corrosion* 54 (1998) 634–640.
- [3] S. Arzola, J. Genescá J, *J Solid State Electrochem* 9 (2005) 197–200.
- [4] M.D. Deffo-Ayagou, T.T. M. Tran, B. Tribollet, J. Kittel, E. Sutter, N. Ferrando, C. Mendibide, C. Duret-Thual, *Electrochimica Acta* (2018) in press.
- [5] H.Y. Ma, X.L. Cheng, S.H. Chen, G.Q. Li, X. Chen, S.B. Lei, H.Q. Yang, *Corrosion* 54 (1998) 634–640.
- [6] M. Houyi, C. Xiaoliang, L. Guiqiu, C. Shenhao, Q. Zhenlan, Z. Shiyong, N. Lin, *Corrosion Science* 42 (2000) 1669–1683.
- [7] NACE International, *Laboratory Testing of Metals for Resistance to Sulfide Stress Cracking and Stress Corrosion Cracking in H₂S Environments*.
- [8] M.A.V Devanathan and Z. Stachurski, *J. Electrochem. Soc.* 111 (1962) 619–623.
- [9] P. Manolatos, M. Jerome, J. Galland, *Electrochimica Acta* 40 (1995) 867–871.
- [10] M. D. Deffo-Ayagou J. Kittel, C. Mendibide, C. Duret-Thual, N. Ferrando, E. Sutter, M. Tran, B. Tribollet. *Corrosion* 2018. 15-19 April 2018. Phoenix, AR (USA), 2018.
- [11] H.Y. Ma, X.L. Cheng, G.Q. Li, S.H. Chen, Z.L. Quan, S.Y. Zhao, L. Niu, *Corrosion Science* 42 (2000) 1669–1683.
- [12] H.Y. Ma, X.L. Cheng, S.H. Chen, G.Q. Li, X. Chen, S.B. Lei, H.Q. Yang, *Corrosion* 54 (1998) 634–640.
- [13] Y. Zheng, *Electrochemical mechanism and model of H₂S corrosion of carbon steel*. PhD thesis, The Russ College of Engineering and Technology of Ohio University, 2015.
- [14] D.C. Grahame, *Chem. Rev.* 41 (1947) 441–501.
- [15] J.L. Crolet, M.R. Bonis. *Corrosion* 2001. 11-16 March. Houston, TX (USA). NACE International, 2001, Paper 01067.
- [16] J.L. Crolet, M.R. Bonis. *Corrosion* 2001. 11-16 March. Houston, TX (USA). NACE International, 2001, Paper 01072.
- [17] J. Kittel, X. Feaugas, J. Creus. *Corrosion* 2016. 07-10 March 2016. Vancouver. NACE International, 2016.