



HAL
open science

Corrosion in amine solvents used for the removal of acid gases

Elisabeth Fleury, Jean Kittel, Bruno Vuillemin, Roland Oltra, Francois Ropital

► **To cite this version:**

Elisabeth Fleury, Jean Kittel, Bruno Vuillemin, Roland Oltra, Francois Ropital. Corrosion in amine solvents used for the removal of acid gases. Eurocorr 2008, Sep 2008, Edinburgh, United Kingdom. hal-02475507

HAL Id: hal-02475507

<https://ifp.hal.science/hal-02475507>

Submitted on 12 Feb 2020

HAL is a multi-disciplinary open access archive for the deposit and dissemination of scientific research documents, whether they are published or not. The documents may come from teaching and research institutions in France or abroad, or from public or private research centers.

L'archive ouverte pluridisciplinaire **HAL**, est destinée au dépôt et à la diffusion de documents scientifiques de niveau recherche, publiés ou non, émanant des établissements d'enseignement et de recherche français ou étrangers, des laboratoires publics ou privés.

Corrosion in amine solvents used for the removal of acid gases

Elisabeth Fleury^a, Jean Kittel ^a, Bruno Vuillemin ^b, Roland Oltra^b, François Ropital ^a

^a IFP – Echangeur de Solaize – 69390 Solaize,

^b ICB – UMR 5209 CNRS – BP 47870 – 21078 Dijon Cedex,

Email : elisabeth.fleury@ifp.fr

Abstract

Processes using amine solvents for the removal of CO₂ have long been used for the treatment of natural gas. More recently, developments in the field of post-combustion CO₂ capture have gained considerable interest for greenhouse gas mitigation. Even though the nature of the amine is different for both applications, the process flow diagrams are very similar. The raw gas is contacted with the amine solvent in an absorber column, and the CO₂ is absorbed by the solvent. The rich solvent containing the CO₂ then circulates to a regenerator, where the temperature is increased to strip the CO₂. The lean solvent then returns to the absorber for a new cycle.

For these processes, corrosion is known to be a major issue. Usually, amines are not corrosive but during operation of amine units, degradation of the solvent may occur due to the reaction with contaminants like oxygen. As a result, corrosive species are formed including other amines and acids products like oxalates, formates and acetates also known as Heat Stable Salts (HSS). Corrosion problems may also depend on other parameters for instance type and concentration of the alkanolamine, temperature of the solvent or CO₂ loading.

In order to extend the limits of gas treating processes, but also to develop the new processes for CO₂ capture, a better understanding of corrosion in amine solvents is required. This paper presents the first results of a study where the impact of several parameters will be evaluated by electrochemical methods. The corrosivity of Monoethanolamine (MEA), Diethanolamine (DEA) and methyl-diethanolamine (MDEA) was compared. Other parameters were studied, among which the impact of CO₂ loading and the concentration in HSS.

Introduction

Basics of acid gas absorption by amines

The primary function of alkanolamine units is to remove acid gases, usually hydrogen sulfide (H_2S) and carbon dioxide (CO_2). Amine processes have long been used for the treatment of natural gas. Indeed, sales specification for natural gas often require to lower the CO_2 content to less than 2%, and H_2S to less than 4 ppm.

More recently, these processes gained interest as a solution that can be used for capturing CO_2 from flue gas streams emitted by coal-fired power stations, which are major contributors to the greenhouse effect and global warming.

Depending on the application, the operation conditions (temperatures, partial pressure of acid gases, ...) may vary. However, for CO_2 capture or gas treatment, the process flow diagram (PFD) is quite similar. A typical PFD is given in Figure 1.

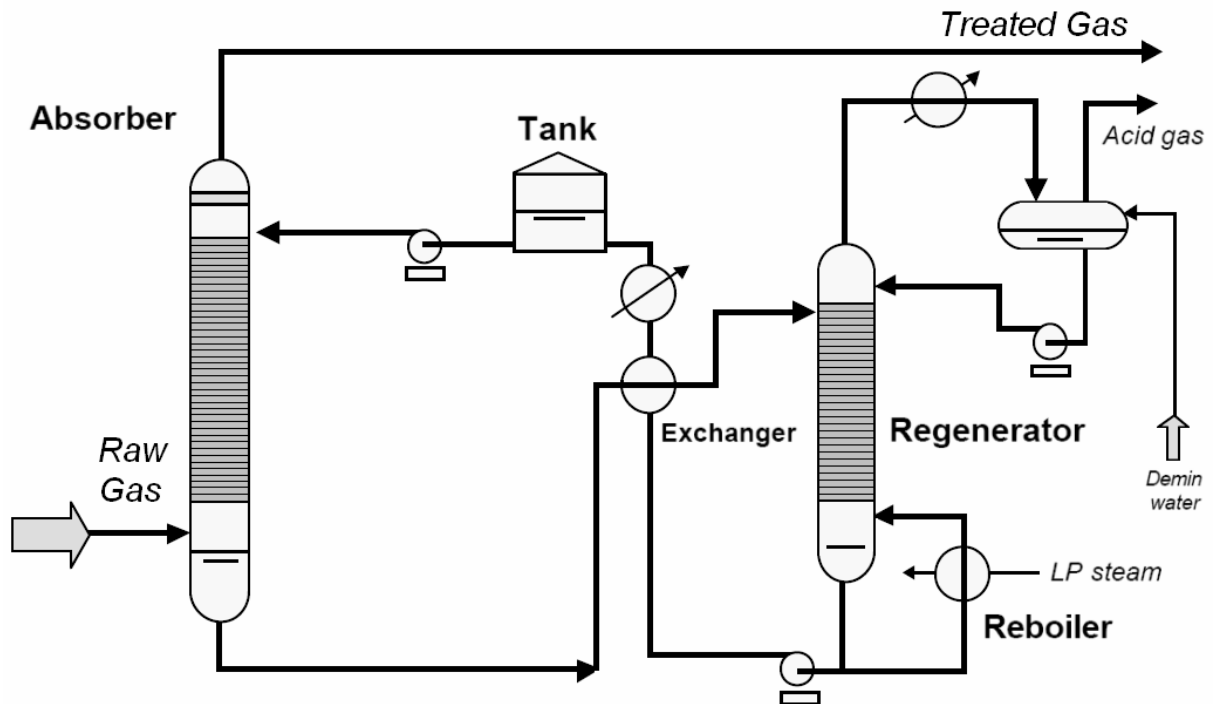

Figure 1: Process flow diagram of gas absorption system.^[1]

The acid gas absorption process is performed through the following steps. The raw gas enters the unit at the bottom of the absorber column, where acid gases are absorbed by the lean amine solvent that flows countercurrent to the raw gas. The treated gas is the overhead product while the rich amine solution flows from the bottom of the absorber to the lean/rich cross exchanger where it is heated before entering the regenerator column. In the regenerator, acid gases are stripped from the rich amine by heat and steam produced by the reboiler. Acid components leave off at the top of the regenerator and go to the overhead condensers and the reflux

accumulator. The hot lean amine from the bottom of the regenerator is cooled via the lean/rich heat exchanger prior to re-entering the absorber.

The basic reactions between CO₂ and amines are given below.

Carbon dioxide reacts with amines by the following reactions where R designates an organic group. These reactions can lead to the formation of carbamates (R.1), bicarbonates (R.2) and carbonates (R.3):

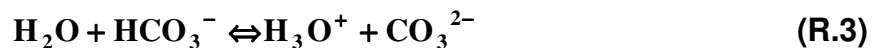
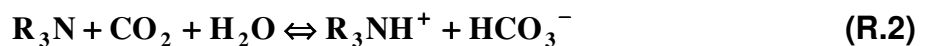

For tertiary amines, the formation of carbamates (Reaction R.1) is impossible. This reaction occurs only with primary and secondary amines, which possess a labile hydrogen. Bicarbonate formation (Reaction R.2) is possible with the three type of amines. Carbonate formation (Reaction R.3) is also possible but negligible in amine solutions because of its too high pKa of 10.33. Usually, a decrease of the pressure or an increase of temperature displaces the equilibrium from the right to the left. This principle is applied in the regenerator for stripping the CO₂ from the solvent.

Corrosion issues in amine units

Many studies have already been made on the corrosion by amine solvents. Most of the studies were made by weight loss measurements and in conditions of gas treatment ^[2,3]. A few recent studies used electrochemical measurements, but focused mainly on CO₂ capture ^[4,5]. The following parameters are recognised to have an impact on corrosion:

- *Type of amine*

As already explained, the choice of amine depends mainly on the application. It is usually admitted that primary amines (like MEA) are more corrosive than secondary amines (like DEA). Tertiary amines (like MDEA) are considered to present the lowest corrosivity. However, it is also well admitted that all amines are usually not intrinsically corrosive. It is only when they react with CO₂, or when they form degradation by-products that their corrosivity can be increased to a high level ^[6].

- *Acid gas loading*

Reactions between alkanolamines and acid gases lead to different complexes. In the case of CO₂, the main by-products are carbamate and bicarbonate, as well as protonated amine (Reaction R.1 and R.2). It is well admitted ^[1,7,6,8,4] that an increase of CO₂ loading increases the corrosion rate. However, the corrosion mechanisms are not yet clearly identified.

- *Degradation products and Heat Stable Salts (HSS)*

Reactions of alkanolamines with both CO₂ and O₂ yield degradation products.

Basic degradation products, such as HEOD¹, BHEP² and THEED³, are formed by reaction of amine with CO₂ [9,10]. Several studies have shown that these degradation products are not corrosive but are good chelates. They are able to easily form complexes with iron. Thus, they reduce the stability of sulphide or carbonate protective layers formed on the surface of steels.

Acid degradation products mainly come from reactions of amine with oxygen (O₂) or from thermal degradation. The main degradation products are salts of carboxylic acid such as oxalic, formic, acetic or glycolic acids. These species are stronger acids than carbonic acid, therefore, they are not regenerated at the reboiler temperature. They are usually named Heat Stable Salts (or HSS).

In this paper, we propose to examine some of the factors involved in corrosion mechanisms of amine-CO₂ systems. The corrosivity of MEA and that of DEA and MDEA are compared. Other parameters such as the CO₂ loading, the HSS contents, and the presence of CO₂ in the raw gas are also studied.

Experiments

Experimental Apparatus

The experiments were carried out in a glass electrochemical corrosion cell as shown in Figure 2. The experimental setup consisted of :

- A three-electrode corrosion cell with a flat circular working electrode made of carbon steel (AISI 1020) with a surface area of 1 cm², an Ag/AgCl reference electrode and a circular Platinum-counter electrode.
- One thermostated bath for heating the doubled-wall test cell, and another bath for the condenser, to prevent water evaporation.
- A thermometer controlling the inner cell temperature.
- A potentiostat (Solartron 1286) and a frequency response analyser (Solartron 1255).
- A gas preparation system for feeding the test cell with blends of carbon dioxide (CO₂), nitrogen (N₂) and air.
- A data acquisition system.

¹ 3-(2-hydroxyéthyl)-2-oxazolidone

² N,N'-bis(2-hydroxyéthyl)pipérazine

³ N,N,N'tris(2-hydroxyéthyl)-éthylènediamine

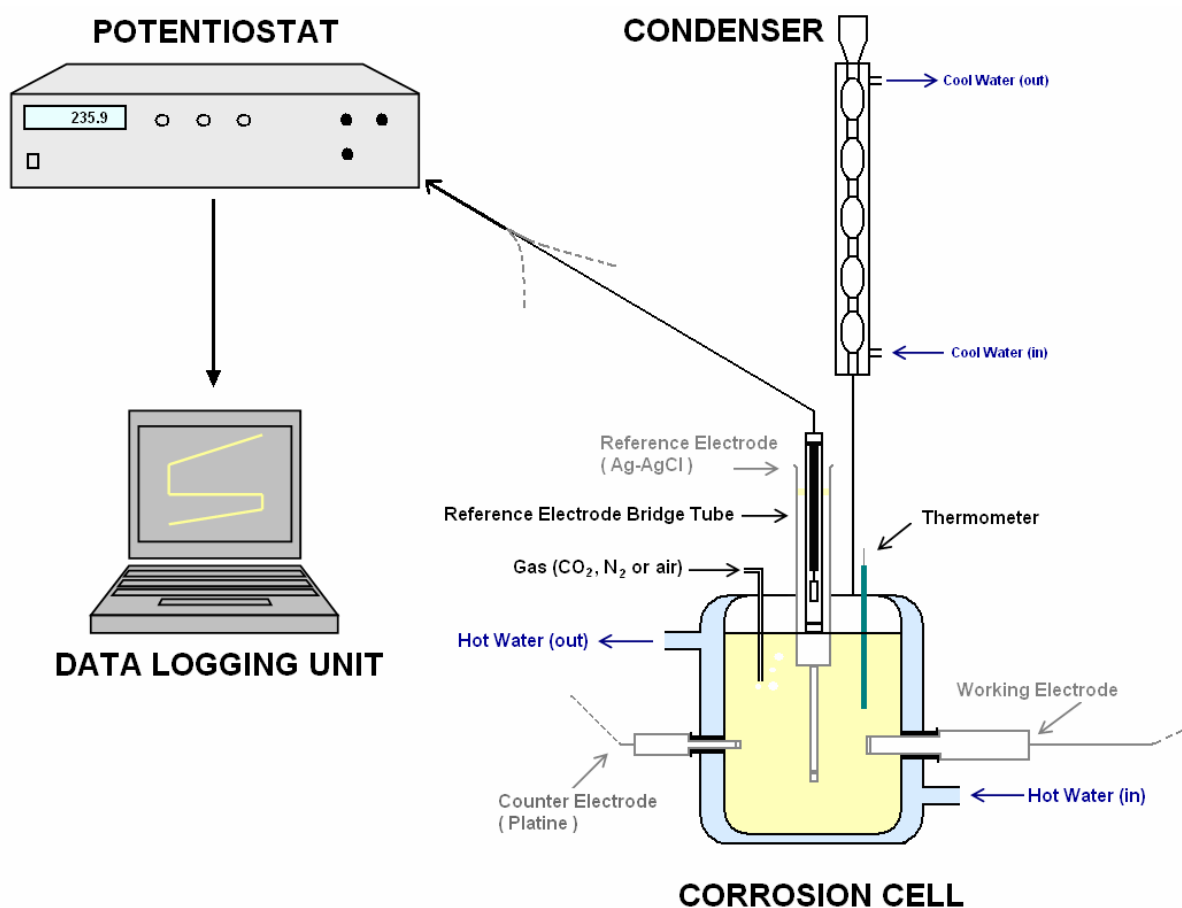

Figure 2: Experimental setup for the electrochemical corrosion tests.

Specimens and Solutions

The corrosion experiments were carried out in 5.0 mol/L aqueous solution of MEA, DEA or MDEA at 80 °C.

At the beginning of each experiment, 300 mL of fresh solvent was introduced in the corrosion cell.

For the experiments in rich amine, the solution was saturated with CO₂ by bubbling for 2 hours until saturation. The obtained loadings (α , in mol of CO₂ per mol of amine) were respectively 0.51 for the MEA, 0.44 for the DEA, and 0.29 for the MDEA. For the experiments in lean conditions, nitrogen (N₂) was used to deaerate the solvent and avoid any CO₂ charging during the tests. Gas bubbling was kept during all the experiments to maintain the equilibrium conditions.

The impact of HSS was evaluated only for MEA. Oxalic acid was used because it leads to the most corrosive heat stable salts identified by Rooney et al.^[11]. To simulate a degraded MEA system, oxalic acid was added to the CO₂-saturated MEA solutions with varying concentrations from 0 g/L to 50 g/L.

Before each experiment, the working electrode was wet-polished to 1200-grit silicon carbide (SiC) papers, rinsed with ethanol and distilled water. Then, it was dried with compressed air and immediately immersed in the test solution.

Experimental Procedure

At the beginning of each experiment, the potential of the WE was measured until it remained constant. Then two different kinds of measurements were performed.

When successive measurements had to be made in the same test solution, Electrochemical Impedance Spectroscopy (EIS) was used. The measurements were made at the free corrosion potential, with an amplitude of 10 mV and from 100 kHz to 5 mHz.

From the EIS diagrams, the polarisation resistance (R_p) was evaluated as the diameter of the semicircular loop in the Nyquist plan. The corrosion current density was then determined as:

$$J_{\text{corr}} = \frac{1}{R_p} \cdot \frac{\beta_a \cdot \beta_c}{\beta_a + \beta_c} \quad (\text{Eq.1})$$

where J_{corr} is the corrosion current density in A/cm², R_p is the polarization resistance in Ohm.cm², β_a et β_c are the anodic and cathodic Tafel coefficients in V. The corrosion rate could then easily be estimated from J_{corr} using the Faraday's law.

At the end of each experiment, potentiodynamic polarization experiments were carried out with a scan rate of 1 mV/s. The scan began from cathodic (-1.5 V vs Ag-AgCl) to anodic (1V vs Ag-AgCl) potentials.

Results

The experimental results focus on the following parameters:

- type of amine,
- CO₂ loading,
- HSS and oxygen contents.

The objectives are first to qualify the experimental methodology, and then to compare the impact of the different parameters on amine solutions corrosivity.

Effect of type of amine

Figure 3 presents the impedance diagrams of AISI 1020 carbon steel in CO₂ saturated solutions of 5M MEA, DEA and MDEA at 80 °C.

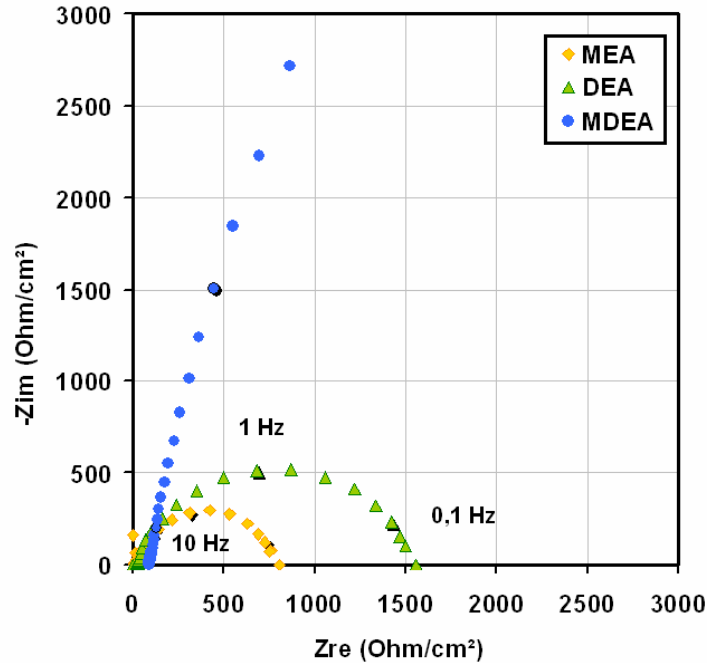

Figure 3: Effect of amine type on carbon steel corrosion. (MEA, DEA and MDEA at 5 mol/L – 80 °C – AISI 1020)

The polarization resistance in the MEA solution is about 800 Ω/cm^2 which corresponds to a corrosion rate of 0.6 mm/year. In the DEA solution, R_p is approximately 1600 Ω/cm^2 , corresponding to 0.3 mm/year. The corrosivity of MDEA is even lower, with a R_p around 45000 Ω/cm^2 , i.e., a corrosion rate of 0.01 mm/year.

These results are in good agreement with the ranking usually agreed in the literature ^[6,4]. An explanation for this difference in amine corrosivity was proposed by Teevens ^[12] who noticed that MEA is a stronger Lewis base than DEA and MDEA. In fact, MEA reacts with CO_2 to form amine carbamates, which in turn, undergo internal dehydration to yield various degradation products. DEA can also react with CO_2 to yield carbamates, however it is a weakest Lewis base so DEA forms less carbamates than MEA. The formation of carbamate from MDEA is impossible, since they fail to yield amides necessary in carbamate ions formation. Moreover, the presence of carbamates in solution would increase the conductivity of amine solution and lead to higher solution corrosivity.

Effect of CO_2 Loading

Figure 4 presents the polarization curves of AISI 1020 CS in a rich or lean 5M MEA solution at 80°C. The consequence of CO_2 loading is an important increase of the cathodic and anodic current densities, by one or two orders of magnitude. Therefore, in a CO_2 saturated solution, we can expect the corrosion rate to be multiplied by 10 to 100 as compared with a lean solution.

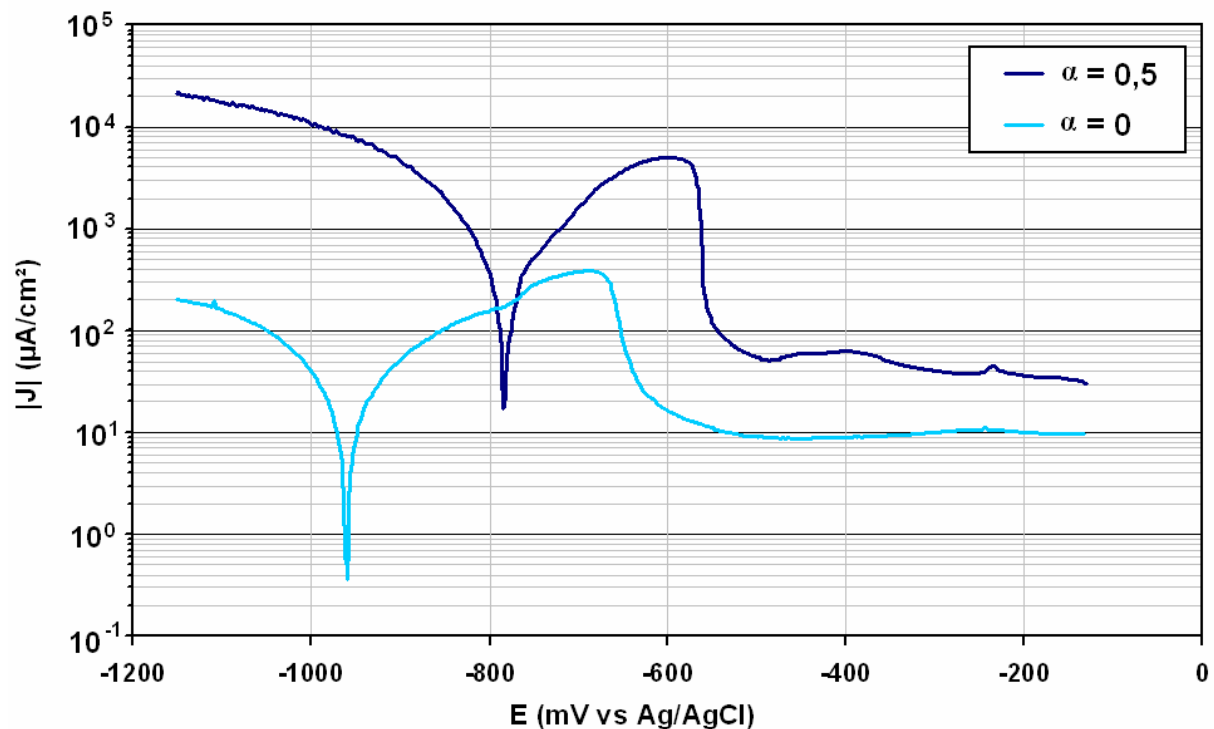

Figure 4: Effect of CO₂ loading on carbon steel corrosion.
(MEA - 5M- 80 °C – AISI 1020)

The influence of CO₂ loading on the corrosion rate has to be examined in the light of reactions R.1 to R.3, which show that an increase of CO₂ loading yields higher amounts of RNH₃⁺ and HCO₃⁻ which in turn dissociate and produce more hydrogen ion (H⁺). Consequently, the amount of hydrogen ion (H⁺) increases and the corrosion process is accelerated^[13].

Effect of Oxygen and Heat Stable Salts

The effect of oxygen was evaluated in a 5M MEA solution at 80 °C, using a gas feed composed of 75% CO₂, 20% N₂ and 5% O₂. The corresponding impedance diagram is presented in Figure 5, and compared with the reference case of pure CO₂ loading, i.e. without oxygen. Polarization resistance seems to be lower when oxygen is present. Indeed, corrosion rate of CS in MEA without O₂ is about 0.6 mm/year whereas the corrosion rate is about 0.9 mm/year in the O₂-MEA system.

Oxygen is known to degrade amines and to form numerous compounds as glycine, ammonia, amides, bicine, as well as several weak acids as formic, acetic, oxalic, glycolic acids. Then, these carboxylic acids yield to formate, acetate, oxalate and glycolate usually named Heat Stable Salts (or HSS). However, no such reaction was expected for the very short duration experiments under O₂. Therefore, the observed increase of corrosivity could be attributed to dissolved O₂ rather than to any degradation product. This increase of corrosivity might be a direct consequence of an increased oxidizing power with dissolved oxygen.

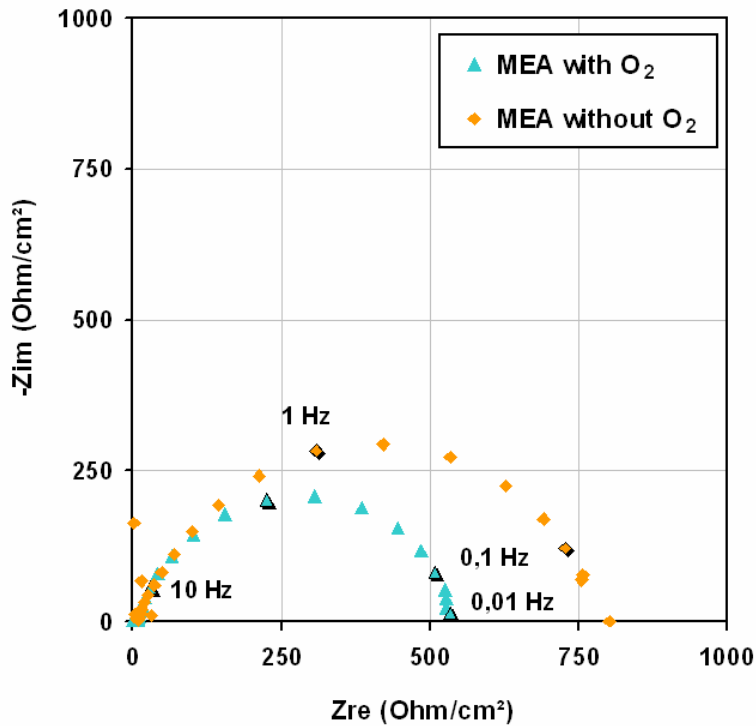

Figure 5: Impedance diagram obtained on carbon steel 1020 with and without O₂. (WE: CS 1020, RE: Ag/AgCl, CE: Pt, MEA, 5M, 80 °C, $\alpha=0.51$ mol CO₂ / mol MEA)

The influence of heat stable salts was also examined. Oxalic acid was chosen because it seems to lead to one of the most corrosive HSS^[11]. Impedance diagrams were measured in MEA solutions with increasing oxalic acid contents from 0 g/L to 50 g/L. The results are presented in Figure 6.

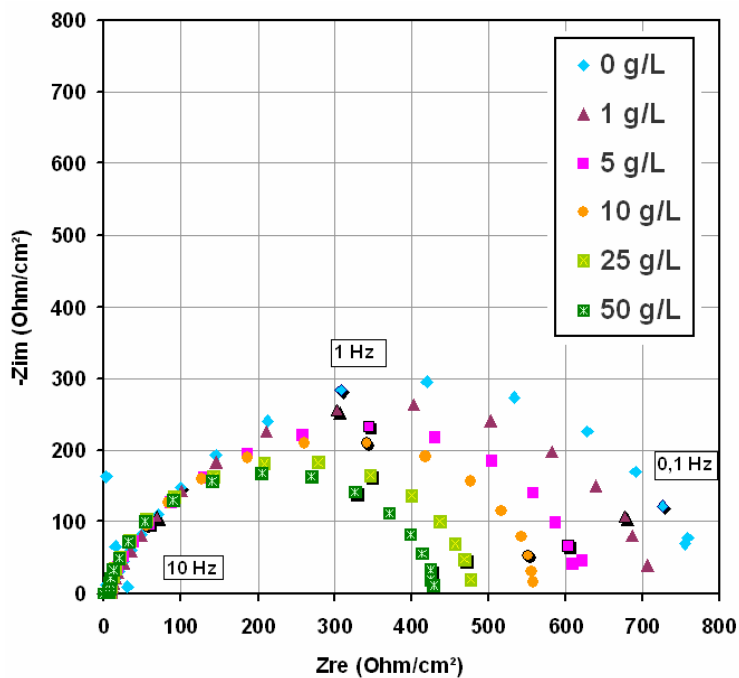

Figure 6: Effect of HSS (oxalic acid) on carbon steel corrosion.

The results show that a higher HSS content leads to a higher corrosion rate. Indeed, the polarization resistance is about 750 Ω/cm^2 when there is no oxalic acid in solution and decreases to 430 Ω/cm^2 when oxalic acid content rises to 50 g/L. The corresponding corrosion rates are 0.7 mm/year when there is no oxalic acid and 1.2 mm/year for the highest oxalic acid concentration.

In gas treatment units, oxalic acid content is usually controlled, and it is recommended to maintain its concentration below 250 ppm. For such low concentrations, the results of this study predict hardly no impact on the corrosion rate. However, it would be erroneous to conclude that the HSS limits are too conservative. Indeed, as explained by Rooney et al. ^[11], HSS are good chelates, and they can easily complex with iron. As a consequence, they contribute to dissolve the protective layers formed on the surface of steel, allowing an easier access of the corrosive solution to the bare metal. HSS are therefore not intrinsically corrosive, as also shown by the results of this study, but they can weaken the protective corrosion product layers, allowing a more rapid corrosion of the metal.

Discussion

From the results of this study, a preliminary ranking can be proposed for the impact of the tested parameters on the corrosivity of amine solutions.

It is quite clear that CO_2 loading has the most significant influence on corrosion rate. For MEA 5M at 80 °C, the difference between lean and rich amine was between one and two orders of magnitude. Comparatively, the corrosivity of different amines varied by a factor five or less. The direct impact of HSS additions was even lower: the corrosion rate was only doubled for a concentration of oxalic acid as high as 50 g/L.

Nevertheless, this does not mean that the type of amine and the presence of HSS do not have an important long term impact for the long real units. The choice of amine is of major importance regarding the degradation. It is expected to have a more rapid degradation with primary and secondary amines compared to tertiary amines. And the presence of HSS also can have more practical impact on real plants than during short exposure laboratory tests. Indeed, synergies between high flow rates and chelating action of HSS can result in erosion-corrosion, which is one of the most important form of corrosion observed in real plants.

These results can also be used to discuss the differences between CO_2 capture and gas treatment applications. Table 1 summarizes the most significant differences in operating conditions with a direct impact on corrosion.

Table 1: Differences in operating conditions of CO_2 capture and gas treating units.

Parameters	CO_2 Capture	Gas Treatment
Type of amine	MEA	DEA or MDEA
Composition of raw gas	5 -10% O_2	no O_2
Lean loading	0.25	nearly 0

For CO₂ capture, primary amines have to be used because of their high reactivity with CO₂, allowing a fast reaction necessary for the treatment of huge quantities of gas streams. MEA represents the n°1 choice for such applications. For gas treatment, secondary or tertiary amines can be used.

Another difference between CO₂ capture and gas treatment relies in the composition of the gas. In the former case, oxygen is often present at a concentration between 5 and 10%. The consequence is an extremely high risk of solvent oxidative degradation. For gas treatment, O₂ is usually not present in the flue gas.

The last difference between the two processes is the lean amine loading. For gas treatment, the regeneration is usually complete, i.e. the lean loading is close to zero. For CO₂ capture, it is more efficient from the energetic point of view to regenerate the amine only partially. Lean loadings around 0.25 mol CO₂/mol amine represent the base case.

Considering the three parameters of this study, it can be seen that CO₂ capture accumulates all the worst cases. MEA is the most corrosive amine, and also the one which is more prone to degradation. Degradation is also favoured by the presence of O₂ in the flue gas. Finally, the corrosivity due to CO₂ loading concerns both the rich and the lean amine sections of the plant.

Finally, the present study considered only carbon steel. Initially, most of the equipment and piping of alkanolamine plants were made of carbon steel, but corrosion problems occurred in the process and led to severe damages, with an important increase of the production costs of the plants. Even if it is possible to reduce corrosion by keeping amine regenerator operating at low temperatures and by minimizing amine solution concentration and CO₂ loading, it is now common practice to replace carbon steels by stainless steels at selected locations. Stainless steels are now mainly used in areas where corrosion is very severe such as the bottom of the absorber, the piping from the absorber to the regenerator and the top of the regenerator, in areas with hot temperatures and high acid gas loadings.

All these aspects have to be taken into account for the future studies in this field. The behaviour of stainless steel grades has to be examined in the worst operating conditions, i.e. high temperature, high acid gas loading, degradation products... This is particularly important in the gas treatment area, where severe corrosion of some stainless steel grades was recently reported for sweet service units (flue gas containing only CO₂) ^[1].

For CO₂ capture, the main issues that need to be studied are: 1/ the real impact of CO₂ loading, especially for intermediate loadings representative of the lean sections; 2/ a closer examination of the degradation products that will be present due to O₂ in the flue gas. Long term experiments with corrosion product layers and flow rate simulations could be useful for a better prediction of corrosion in degraded solutions.

Conclusions

The objectives of this study were to illustrate the impact of several parameters on the corrosivity of CO₂-amine system.

It appeared that CO₂ loading was the most influent parameter, with a difference of one or two orders of magnitude between the corrosion rate of a lean amine and that of a rich solvent. Comparatively, in CO₂ saturated solutions, MEA corrosivity was found to be twice more corrosive than DEA, and thirty times more corrosive than MDEA. The presence of degradation products had only a slight impact on the corrosivity. However, it has to be emphasised that the type of amine and degradation reactions must still be considered with great care for real units operations. Especially, HSS have a chelating action, leading to less protective corrosion product layers. This long term impact could not be well illustrated by short term exposure tests in the laboratory.

These results could be used for comparing the cases of CO₂ capture and gas treatment. It appeared that CO₂ capture cumulates all the more corrosive factors: MEA is the reference solvent, oxygen is present in the flue gas leading to oxidative degradation, and the lean amine loading is 0.25 mol CO₂/mol amine, whereas it is zero in gas treatment units. All these differences have to be taken into account for the design of CO₂ capture plants.

Finally, for future studies, it is also important to consider not only carbon steel, which has long been the preferred material for such units, but also stainless steel grades.

Acknowledgements

The authors would like to thank Alexandre Bonneau, for his assistance in electrochemical measurements.

References

1. M. Bonis, J.-P. Ballaguet, and C. Rigail, *GPA Annual Convention Proceedings*, New Orleans, **2000**, 16.
2. P. C. Rooney, Bacon, and DuPart, *Hydrocarbon Processing*, **1996**, 75 N.3, 95.
3. P. C. Rooney, DuPart, and Bacon, *Hydrocarbon Processing*, **1997**, 76 N.4, 65.
4. A. Veawab, P. Tontiwachwuthikul, and A. Chakma, *Industry Engineer Chemistry Results*, **1999**, 38, 3917.
5. A. Veawab and A. Aroonwilas, *Corrosion Science*, **2002**, 44, 967.
6. M. S. DuPart, T. Bacon, and D. J. Edwards, *Hydrocarbon Processing*, **1993**, 72 N.5, 89.
7. M. S. DuPart, T. Bacon, and D. J. Edwards, *Hydrocarbon Processing*, **1993**, 72 N.4, 75.
8. M. G. Mogul, *Hydrocarbon Processing*, **1999**, 47.
9. C. Blanc, M. Grall, and G. Demarais, *Laurence Reid Gas Conditioning Conference*, **1982**, 97 N.12,
10. M. S. DuPart, P. C. Rooney, and T. R. Bacon, *Hydrocarbon Processing*, **1999**, 1.
11. P. C. Rooney and M. S. DuPart, *NACE*, Houston, Texas, **2000**, Paper 00494.
12. P. J. Teevens, *NACE*, Las Vegas, Nevada, **1990**, Paper 198.
13. Veawab, Tontiwachwuthikul, and Chakma, *Industry Engineer Chemistry Results*, **1998**, Vol. 38, 308.