



**HAL**  
open science

## On-line recovery system coupled to a Rock-Eval® device: An analytical methodology for characterization of liquid and solid samples

Pierre Cadeau, Maria-Fernanda Romero-Sarmiento, Olivier Sissmann, Valérie  
Beaumont

### ► To cite this version:

Pierre Cadeau, Maria-Fernanda Romero-Sarmiento, Olivier Sissmann, Valérie Beaumont. On-line recovery system coupled to a Rock-Eval® device: An analytical methodology for characterization of liquid and solid samples. *Organic Geochemistry*, 2020, 144, pp.104014. 10.1016/j.orggeochem.2020.104014 . hal-02889208

**HAL Id: hal-02889208**

**<https://ifp.hal.science/hal-02889208>**

Submitted on 3 Jul 2020

**HAL** is a multi-disciplinary open access archive for the deposit and dissemination of scientific research documents, whether they are published or not. The documents may come from teaching and research institutions in France or abroad, or from public or private research centers.

L'archive ouverte pluridisciplinaire **HAL**, est destinée au dépôt et à la diffusion de documents scientifiques de niveau recherche, publiés ou non, émanant des établissements d'enseignement et de recherche français ou étrangers, des laboratoires publics ou privés.

# On-line recovery system coupled to a Rock-Eval<sup>®</sup> device: An analytical methodology to characterize liquid and solid samples

Pierre [Cadeau](#)

Maria-Fernanda [Romero-Sarmiento\\*](#)

[maria-fernanda.romero-sarmiento@ifpen.fr](mailto:maria-fernanda.romero-sarmiento@ifpen.fr)

Olivier [Sissmann](#)

Valérie [Beaumont](#)

IFP Énergies nouvelles (IFPEN), Direction Géosciences, 1 et 4 avenue de Bois-Préau, 92852 Rueil-Malmaison Cedex, France

\*Corresponding author.

*Associate Editor*—**Clifford C. Walters**

---

## Abstract

The Rock-Eval<sup>®</sup> device has been widely used to identify the type and the thermal maturity of sedimentary organic matter as well as quantifying the total organic carbon content. Traditionally, it is a screening tool to estimate the petroleum generation potential of source rocks using standardize parameters. More recently, a new Rock-Eval<sup>®</sup> method (Shale Play™) was proposed to investigate the hydrocarbon content in liquid-rich tight rock samples. In this study, we describe a dual vacuum and on-line system that was developed to recover most compounds that are thermally released during a Rock-Eval<sup>®</sup> Shale Play™ analysis. Thermally vaporized products are divided so that half is analyzed by the Rock-Eval<sup>®</sup> flame ionization detector (FID) while the other portion is cryogenically trapped in the on-line recovery system. The trapped products can then be transferred via a vacuum line system into a sample vial for subsequent molecular and/or isotopic composition analyses. The recovery vacuum line volumes were calibrated using known quantities of gas (CH<sub>4</sub> and CO<sub>2</sub>). Sample transfer from without isotopic fractionation was demonstrated for CO<sub>2</sub> evolved from Rock-Eval<sup>®</sup> preparation of pure carbonate standards (siderite, magnesite and azurite). Recovery efficiencies were first measured on C<sub>8</sub>-C<sub>16</sub> *n*-alkane standards and then on produced oil samples. Results indicate a high quantitative recovery and an accurate mass balance of most compounds released during the Shale Play™ Sh0 thermovaporization step (100–200 °C). Thermally vaporized compounds released at higher temperatures Sh1 (200–350 °C) are recovered at lower efficiencies but are still suitable for subsequent characterization. The coupled Rock-Eval<sup>®</sup> and recovery system could have applications beyond petroleum geochemistry.

---

**Keywords:** On-line recovery system; Open-system pyrolysis; Rock-Eval<sup>®</sup>; Shale Play™ method; GC-FID & GC-IR-MS analyses; Carbonates; Alkanes; Oils

## 1 Introduction

Instrumentations designed to analyze the composition of the thermal desorbed/pyrolyzed hydrocarbons from the artificial maturation of organic matter have been used for decades. [Lattimer \(1993\)](#) performed one of the first thermal desorption/decomposition experiments coupled with mass spectrometry (TD-MS) to identify residual volatile chemicals, organic additives and degradation products of several polypropylene compounds. Since then, many thermal desorption experiments coupled with gas chromatography (GC) and/or mass spectrometry analysis have been performed. Most have used a simple thermally isolated furnace directly connected to a gas chromatography inlet followed by a FID and/or MS detection. TD-GC-FID-MS has been demonstrated to be a versatile system with many applications in petroleum geochemistry including, source rock kerogen and asphaltene characterization (e.g., [Larter and Horsfield, 1993](#); [Zhang et al., 2016, 2017](#)) and fossil fuel kinetics (e.g., [Seeley et al., 2018](#) [Larter and Douglas, 1982](#); [Tang and Stauffer, 1994](#)). TD-GC-FID-MS has also found wider applications in environmental studies where it has been used to assess the impact of oil pollution (e.g., [Otto et al., 2015](#); [Harshman et al., 2017](#); [Seeley et al., 2018](#)), and the consequence of oil spills on human health (e.g., [Shultz et al., 2014](#)), coastal restoration (e.g., [Zengel et al., 2015](#)), marine species effects (e.g., [Wilson et al., 2014](#)), and microbial ecology (e.g., [King et al., 2015](#)). It is a key tool in characterizing microplastic contaminants in the environment (e.g., [Nuelle et al., 2014](#); [Yanagisawa et al., 2018](#); [Duemichen et al., 2019](#); [Rios Mendoza and Balcer, 2019](#)). Other applications have been made in the characterization of soil organic matter (e.g., [Leinweber and Schulten, 1999](#)) and radiocarbon dating (e.g., [Rosenheim et al., 2013](#)).

Many customized instrument configurations have been designed for specific applications. For example, compositional analysis of organic volatiles in fluid inclusions requires the decrepitation of the mineral matrix. This has been accomplished by various systems including an on-line crushing, thermal expansion, and laser ablation ([Volk and George, 2019](#)). [Otto et al. \(2015\)](#) interfaced a thermal desorption/pyrolysis unit to a gas chromatography that split

the effluent to two mass spectrometers, one using photon ionization and the other using electron ionization, allowing for the simultaneous detection of both parent ion and ion fragment spectra. The system was used to investigate polycyclic aromatic hydrocarbon (PAHs) pollutants and their degradation within dissolved organic matter (DOM) in the Baltic Sea. [Kano et al. \(2015\)](#) set up an analytical pyrolysis device that allowed for the measurement of the less volatile pyrolyzates consisting of a vertical microfurnace pyrolyzer and a movable pyrolysis tube, which allowed the less volatile pyrolyzates to be trapped in the lower part that could then be flushed with a solvent for offline analysis. [Nsaful et al. \(2015\)](#) used a thermogravimetric analyzer (TGA) to thermally degrade lignocellulose with the volatilized pyrolyzates trapped and subsequently analyzed by GC-MS.

In this study, we describe a new analytical system that interfaces a Rock-Eval® device with a dual vacuum and on-line recovery system. Rock-Eval® has been widely used over the last forty years to identify the thermal maturity, the total organic carbon (TOC) content and the type of organic matter (OM) within sedimentary rock samples. It is the primary screening tool to characterize rocks for their petroleum generation potential ([Espitalié et al., 1977](#); [Espitalié et al., 1986](#); [Behar et al., 1997](#); [Lafargue et al., 1998](#); [Behar et al., 2001](#)). Modified thermal thermovaporization and pyrolysis programs have been developed and applied to evaluate the properties of various investigated samples (e.g. [Abrams et al., 2017](#); [Inan et al., 2018](#)). The Shale Play™ method developed by IFPEN in 2014 is a specific Rock-Eval® pyrolysis program dedicated to the characterization of liquid-rich rocks to better assess the *in-situ* liquid hydrocarbons still present within low permeability shales, tight sandstones and carbons, and other solid materials. This method generates new Rock-Eval® parameters (Sh0, Sh1 and Sh2 peaks) that can be used to obtain better quantifications of free and adsorbed liquid hydrocarbons, more accurate Rock-Eval®  $T_{max}$  values, and estimations of the original oil in place ([Fig. 1](#); [Romero-Sarmiento et al., 2014, 2016a,b, 2017, Romero-Sarmiento, 2019](#)). Selective solvent extractions showed that Sh2 is dominated by nonvolatile polar compounds and asphaltenes that behave similar to kerogen ([Romero-Sarmiento et al., 2016b](#)). The chemical composition of both Sh0 and Sh1 peaks was determined by reproducing the Shale Play™ temperature program in a thermal desorption device directly coupled to a gas-chromatography using dual mass spectrometry and flame ionization detection (TD-GC-FID-MS; [Romero-Sarmiento et al., 2016a](#)). Sh0 (100–200 °C) is comprised by free and sorbed low-to-medium molecular weight thermovaporized hydrocarbons (20), whereas Sh1 (200–350 °C) is comprised by medium and high molecular weight thermovaporized compounds (~C<sub>12</sub> to C<sub>30</sub>).

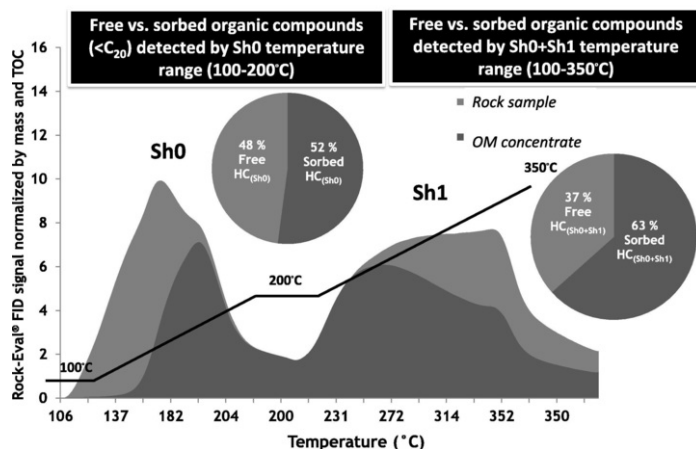

**Fig. 1** Rock-Eval® Shale Play™ Sh0 and Sh1 parameters obtained from whole-rock sample and its corresponding organic matter (OM) concentrate isolated by standard non-oxidizing acid treatments and drying procedures. An analytical approach to predict both free versus sorbed hydrocarbon contents in liquid-rich source rocks (modified from [Romero-Sarmiento, 2019](#)).

The system described below utilizes a Rock-Eval® device coupled to a dual vacuum and on-line recovery system. This allows simultaneous determination of the Shale Play™ parameters and subsequent chemical characterization of the released hydrocarbons from the same sample, thereby eliminating any bias that could arise from conducting independent analyses on different samples. For instance, source rocks can be extremely heterogeneous and while efforts can be made to homogenise a samples, uncertainties arising from sub-samples remain. The main objective of this work was, therefore, to develop a recovery system interfaced directly with a Rock-Eval® device. The advantage of this analytical system lies in (a) the recovery of most compounds released during a Rock-Eval® analysis in gaseous or liquid phase (in solvent), (b) the possibility to store the recovered compounds for subsequent off-line analyses using different techniques (e.g. GC-FID/MS, GC-C-IRMS), (c) the capability to select a specific compound either by separating and using different cold traps, or by changing the pyrolysis temperature program and (d) the simultaneous acquisition of Rock-Eval® parameters.

## 2 On-line recovery system coupled to a Rock-Eval® device

In this study, we describe an analytical system designed to recover, purify, concentrate and re-sample compounds released during a Rock-Eval® analysis ([Fig. 2](#); [Romero-Sarmiento et al., 2019](#)). The first design section consists

of a U-trap that can be connected to or isolated from the Rock-Eval<sup>®</sup> device and the vacuum transfer line system. This is constructed of 1/4 in. stainless steel Swagelok tubing and two three-ways valves (Valves V1 and V2, Fig. 2). The U-tube condenses thermally desorbed/decomposed products from the Rock-Eval<sup>®</sup> over a temperature interval. The nitrogen carrier gas flow from the Rock-Eval<sup>®</sup> device fixed at 100  $\mu\text{L}/\text{min}$  was previously controlled and split into two equal parts (50/50). A two-way valve (V3) isolates the U-tube condenser from the rest of the vacuum-line system that is used to purify and separate all compounds recovered in the U-trap. This section is constructed from stainless steel VCR Swagelok tubing and VCR Swagelok sealed valves (V3 to V12) gaskets. It includes two gas traps (T1 and T2, with and without silica gel respectively) and a sample recovery port for collecting liquid in a glass vial that is also cooled with liquid nitrogen. The entire unit can be evacuated by both primary rough and/or secondary turbo pumps, monitored by a vacuum Pfeiffer gauge. Like the U-trap, it can be heated to 150  $^{\circ}\text{C}$  to facilitate the release and quantitative transfer of less volatile compounds.

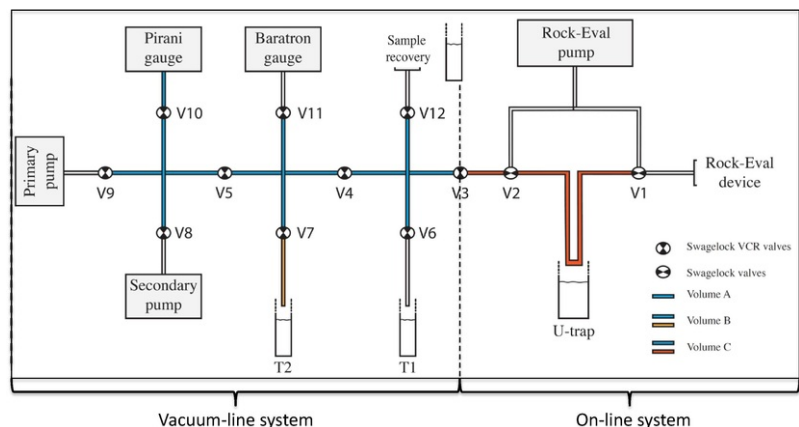
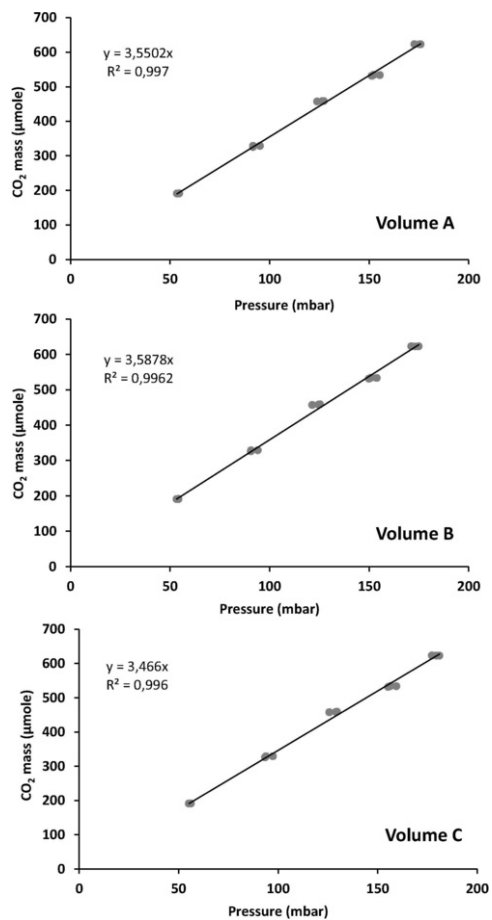

**Fig. 2** Analytical design of the dual vacuum and on-line recovery system coupled to a Rock-Eval<sup>®</sup> device.

During a Rock-Eval<sup>®</sup> analysis, the nitrogen carrier gas bearing the released organic compounds is split to the FID to obtain Rock-Eval<sup>®</sup> parameters and the U-trap cooled with liquid nitrogen while isolated from the rest of the vacuum line. Depending on the analytical purpose, the U-trap can be connected during the complete pyrolysis cycle or only during a selected part of the thermovaporization and/or pyrolysis program. When the Rock-Eval<sup>®</sup> analysis is completed, the U-trap is isolated from the Rock-Eval<sup>®</sup> device and connected to the vacuum line where the evolved gases can be purified between cold traps T1 and T2 and the gas/liquids can be recovered for off-line analysis.

## 2.1 Calibration and validation of the vacuum line volumes

Several tests were performed using  $\text{CO}_2$  and  $\text{CH}_4$  gas standards to check for leaks and to calibrate the segmented volumes through the entire trapping and vacuum transfer system. Samples of pure gas  $\text{CO}_2$  or  $\text{CH}_4$  were introduced into the vacuum-line part from glass vials at the sampling location (T2; Fig. 2) and then sequentially trapped and released in the different parts of the vacuum line (T1 and U-trap) to test and calibrate the different volumes of the vacuum line (Fig. 2). Results from the vacuum line volume calibration tests performed using  $\text{CO}_2$  standards are illustrated in Fig. 3 and the raw data are presented in Table 1. Fig. 3 shows the three different volumes studied through the vacuum line (volumes A, B & C) illustrating the relationship between the pressure values obtained with the Pfeiffer gauge within the vacuum line and the different amount of  $\text{CO}_2$  introduced. These three plots (Fig. 3) show an excellent correlation between the increase of  $\text{CO}_2$  amount and the pressures in the vacuum line ( $R^2$  between 0.996 and 0.997). For each different  $\text{CO}_2$  amount introduced in the vacuum line (five different amounts between 191 and 623  $\mu\text{moles}$ ; Table 1), three analyses were performed and showed a reproducibility better than  $\pm 2\%$ . In addition, the initial pressure ( $P_{\text{initial}}$ ) obtained at the beginning and the end of each analysis in the same volume of the vacuum line indicates a complete sample recovery ( $\Delta P_{\text{initial}}$ :  $100\% \pm 1\%$ ; Table 1).



**Fig. 3** Validation of the vacuum line volumes showing pressure variation obtained with the Pfeiffer gauge as a function of the different CO<sub>2</sub> mass introduced into the volumes A, B and C.

**Table 1** Validation of the vacuum line volumes: Results from CO<sub>2</sub> tests.

CO <sub>2</sub>		Vacuum line system			
Amount	P <sub>initial</sub>	P <sub>B</sub>	P <sub>C</sub>	P <sub>initial</sub>	Δ P <sub>initial</sub>
(µmole)	(mbar)	(mbar)	(mbar)	(mbar)	(%)
191	54.6	54.2	56.1	54.7	100
191	53.5	53.3	55.2	53.7	100
191	54.5	54.2	56.2	54.8	101
	54.2 ± 0.5	53.9 ± 0.4	55.8 ± 0.4	54.4 ± 0.5	-
329	95.2	94.1	97.4	95	100
326	91.7	90.6	93.5	91.6	100

329	91.7	90.7	93.9	91.7	100
	92.9 ± 1.6	91.8 ± 1.5	94.9 ± 1.6	92.8 ± 1.5	-
458	126.5	124.7	129	125.7	99
457	123.9	121.5	125.8	123.1	99
459	127.2	125.3	129.6	126.8	100
	125.9 ± 1.3	123.8 ± 1.6	128.1 ± 1.6	125.2 ± 1.4	-
533	155.4	153.9	159.4	155.4	100
534	152.3	150.9	156.4	152.2	100
531	151.4	149.9	155.3	151.2	100
	153.0 ± 1.6	151.6 ± 1.6	157.0 ± 1.6	152.9 ± 1.6	-
623	175.4	173.4	179.5	175.5	100
623	172.8	171.3	177.3	173	100
623	175.9	174.9	181	176.4	100
	174.7 ± 1.3	173.2 ± 1.3	179.3 ± 1.3	175.0 ± 1.3	-

Results from CH<sub>4</sub> standards tests performed on the vacuum line are showed in the Fig. 4 and the raw data presented in Table 2. For CH<sub>4</sub> tests, Fig. 4 only shows the two different volumes studied through the vacuum line (volumes A & B) illustrating the relationship between the pressure values obtained with Pfeiffer gauge within the vacuum line and the different amount of CH<sub>4</sub> introduced. The obtained results from CH<sub>4</sub> tests also confirmed the volume validation performed by CO<sub>2</sub> standards, showing (i) a good correlation between the increase of CH<sub>4</sub> amount and the pressures in the vacuum line ( $R^2$  comprise between 0.97 and 0.98), (ii) a good reproducibility of all data for the different CH<sub>4</sub> amounts introduced in the vacuum line (better than ±2%, Table 2), and (iii) a good recovery percentage between initial pressure ( $P_{\text{initial}}$ ) obtained at the beginning and the end of each analysis in the same volume A of the vacuum line ( $\Delta P_{\text{initial}}$ : 100% ± 1%; Table 2).

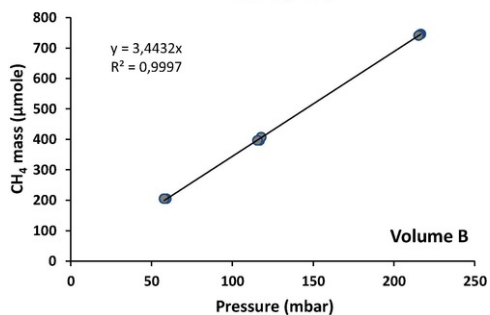
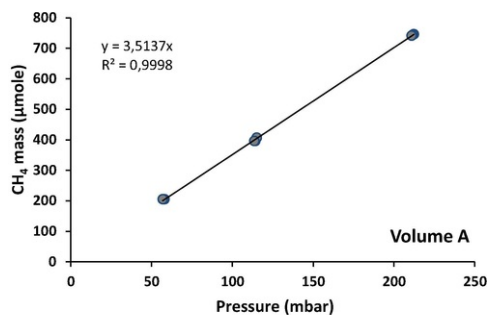

**Fig. 4** Validation of the vacuum line volumes showing pressure variation obtained with the Pfeiffer gauge as a function of the different CH<sub>4</sub> mass introduced into the volumes A and B.

**Table 2** Validation of the vacuum line volumes: Results from CH<sub>4</sub> tests.

CH <sub>4</sub>	Vacuum line system		
Amount	P <sub>initial</sub>	P <sub>A</sub>	Δ P <sub>initial</sub>
(μmole)	(mbar)	(mbar)	(%)
205	58.0	59.1	100
205	57.0	57.8	100
205	56.9	57.9	101
	57.3 ± 0.5	58.3 ± 0.6	
396	114.2	116.8	100
407	115.1	117.8	100
396	113.6	115.6	100
	114.3 ± 0.5	116.7 ± 0.8	
746	212.3	216.6	100
744	211.7	216.1	100
741	210.9	215.2	100
	211.6 ± 0.5	216.0 ± 0.5	

## 2.2 Validation of the vacuum line transference without isotopic fractionation

Varying amount of two CO<sub>2</sub> gas standard references with different δ<sup>13</sup>C values were transferred between the system volumes and then analyzed by gas chromatography conversion isotope-ratio mass spectrometer (GC-C-IRMS; Fig. 5 and Table 3). All tests report similar δ<sup>13</sup>C values compare to direct measurements of the CO<sub>2</sub> gas standards (<±0.6‰), with a low standard deviation calculated from at least three measurements and a good reproducibility for each sample and amount (±0.2‰). These calibration results confirm that the developed vacuum-line system is well designed to quantitatively trap and recover gaseous species for carbon isotopic analysis without fractionation.

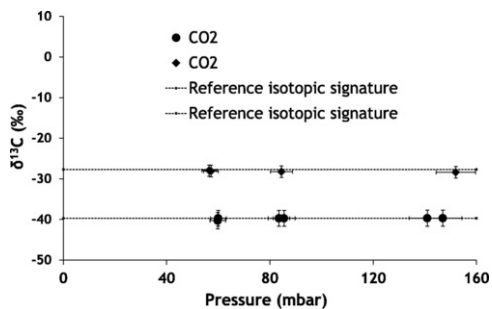

**Fig. 5** δ<sup>13</sup>C values of the recovered CO<sub>2</sub> after vacuum line volume calibration tests comparing to the reference isotopic signature.

**Table 3** δ<sup>13</sup>C values of the recovered CO<sub>2</sub> after vacuum line volume calibration tests.

CO <sub>2</sub>	Vacuum line system

Amount ( $\mu\text{mole}$ )	$\delta^{13}\text{C}$ ( $\text{‰}$ )	$\sigma^*$ ( $\text{‰}$ )	Expected $\delta^{13}\text{C}$ ( $\text{‰}$ )
191	-27.96	0.07	-27.7
191	-28.11	0.11	
458	-28.24	0.16	
457	-28.41	0.11	
205	-40.27	0.33	-39.7
205	-39.73	0.14	
205	-39.70	0.16	
396	-39.73	0.09	
407	-39.72	0.14	
396	-39.70	0.08	

\*  $\sigma$  was calculated from triplicate  $\delta^{13}\text{C}$  measurements

## 2.3 Validation of the on-line recovery system coupled to a Rock-Eval<sup>®</sup> device

In order to validate the on-line part of the system coupled to the Rock-Eval<sup>®</sup> device, three mineral standards, magnetite, siderite and azurite, were analyzed as previously described by [Pillot et al. \(2014\)](#). These carbonates have different thermal stability and will release  $\text{CO}_2$  at different temperature steps during the Rock-Eval<sup>®</sup> analysis.

The  $\text{CO}_2$  generated from the Rock-Eval<sup>®</sup> pyrolysis of these carbonate samples was quantified in the vacuum line using the previously calibrated volumes C ([Fig. 6](#)). The  $\text{CO}_2$  was then purified and recovered for GC-C-IRMS analysis ([Fig. 7](#); [Table 4](#)).

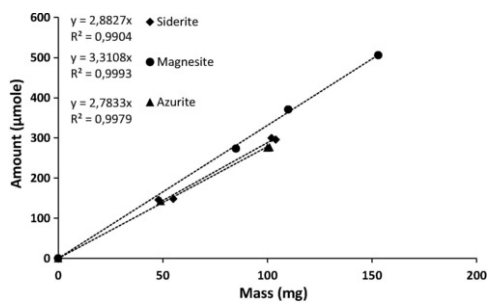

**Fig. 6** Validation of the on-line volume coupled to the Rock-Eval<sup>®</sup> device showing ~~pressure~~ (Please replace pressure by  $\text{CO}_2$ ) variation obtained with the Pfeiffer gauge as a function of the different carbonates mass introduced into the Rock-Eval<sup>®</sup> device.



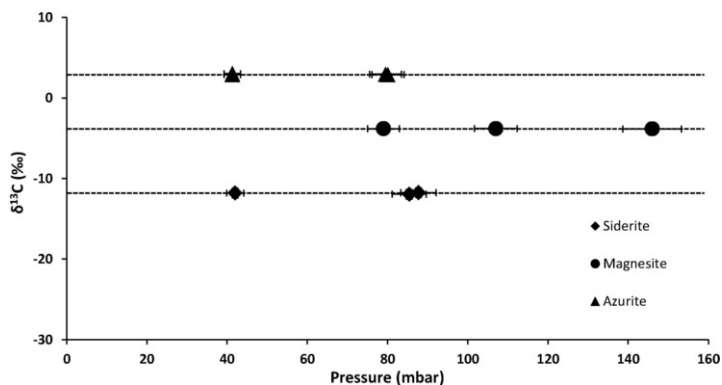

Fig. 7  $\delta^{13}\text{C}$  values of carbonates standards (siderite, magnesite, azurite) obtained by GC-C-IRMS analyses from vacuum line recovery system.

**Table 4** Raw data of vacuum line quantification and isotopic measurement by GC-C-IRMS analysis of carbonates standards (siderite, magnesite, azurite).

Sample	Dual vacuum and on-line system			GC-C IRMS	
	Amount	$P_B$	Concentration	$\delta^{13}\text{C}$	$\sigma$
	(mg)	(mbar)	( $\mu\text{mole/mg}$ )	(‰)	(‰)
Siderite	48	42	146	-11.79	0.11
	55	42.6	148	-11.82	0.18
	104	85.4	296	-11.94	0.12
	102	86.6	300	-11.76	0.09
Azurite	49	41.3	143	3.03	0.06
	49	41.3	143	2.89	0.15
	100	79.5	276	2.95	0.04
	101	80.1	277	2.90	0.10
Magnesite	85	79	274	-3.82	0.04
	110	107	371	-3.81	0.03
	153	146	506	-3.84	0.03

Fig. 6 shows a good correlation between different carbonates amount analyzed on the Rock-Eval<sup>®</sup> ( $R^2$  at 0.99 in each case) and the pressures in the vacuum line (Table 4), similar to the calibrations presented above. Reproducibility of all data is better than  $\pm 2\%$ . These results show that the on-line recovery system coupled to the Rock-Eval<sup>®</sup> device is well designed to quantitatively trap and recover gaseous species released from the Rock-Eval<sup>®</sup> for quantification and carbon isotopic analysis.

### 3 Application to the Shale Play<sup>™</sup> method

The dual vacuum and on-line system coupled to a Rock-Eval<sup>®</sup> was tested using several *n*-alkane standards (octane, decane, tetradecane, and hexadecane) using the Shale Play<sup>™</sup> temperature program. These *n*-alkanes were selected to specifically focus on the 100 °C to 350 °C temperature range spanned by the Sh0 and Sh1 peaks. Following procedures described in Romero-Sarmiento et al. (2016a), several aliquots of *n*-alkanes were weighed in Rock-Eval<sup>®</sup> crucibles filled with silica. A part of the hydrocarbons released during the Rock-Eval<sup>®</sup> temperature program passed through the U-trap where they are trapped while the rest of the vacuum recovery system remains isolated. When the temperature reaches 350 °C, the U-trap was isolated from the Rock-Eval<sup>®</sup> device, heated to 150 °C to facilitate transfer, and connected to the vacuum line section where it is collected in an evacuated glass vial cooled with

liquid nitrogen. When the transfer was completed, the glass vial containing the recovered fraction was disconnected from the vacuum line, rinsed with solvent and analyzed by a liquid gas chromatograph. Rock-Eval<sup>®</sup> FID signal normalized by the initial mass for each pure *n*-alkane are presented in the Fig. 8 and the raw data as well as the percentage of organic compounds recovery calculated from GC traces chromatogram are listed in Table 5.

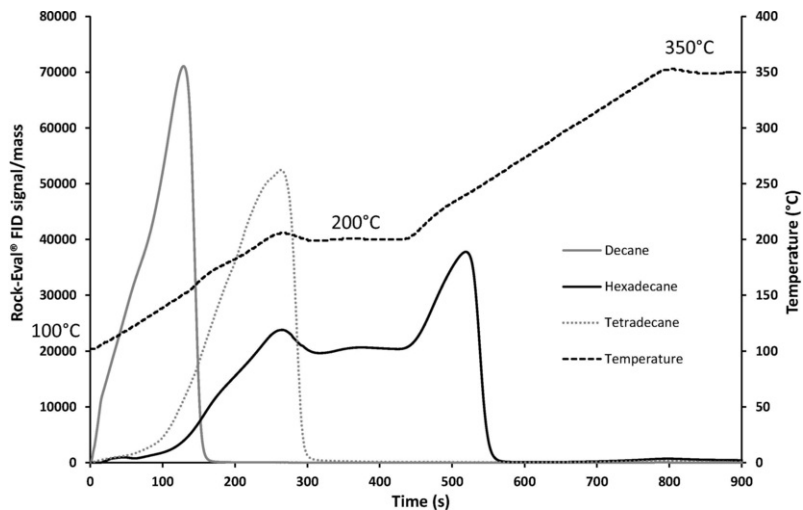

**Fig. 8** Rock-Eval<sup>®</sup> FID signals between 100 and 350 °C normalized by the initial mass for pure *n*-alkane standards: decane, tetradecane and hexadecane.

**Table 5** Pure *n*-alkane recovery through the developed on-line system coupled to Rock-Eval<sup>®</sup> device showing loss and correction factor associated with the evaporation of the investigated pure *n*-alkanes.

<i>n</i> -alkanes	Initial Amount (mg)	Recovered Amount (mg)	Recovery (%)	%Loss to evaporation* (%)	%Recovery correct for evaporation (%)
Octane	7.60	6.58	87	24.7	99
Decane	8.43	6.68	79	5.3	81
Tetradecane	7.77	6.13	78	1.1	79
Hexadecane	8.3	6.01	72	0.2	72

\* Loss from evaporation occurring during solvent extraction of trapped *n*-alkanes.

Measured recoveries of the *n*-alkanes ranged from 72 to 87% (Table 5) and is dependent on volatility, with the lowest molecular weight species showing the lowest recovery. However, a portion of the *n*-alkanes is known to be lost from evaporation as the trapping vial is extracted with solvent in the open air. The amount of evaporative loss was measured from vials prepared with ~4 mg of each *n*-alkane and solvent extracted. As expected, *n*-C<sub>8</sub>, the most volatile hydrocarbon, experiences the greatest lose to evaporation while nearly all of the *n*-C<sub>16</sub> was recovered (Table 5). Accounting for evaporation, the corrected recoveries range from 99% of *n*-C<sub>8</sub> to a low of 72% for *n*-C<sub>16</sub>. These results indicate that some of the higher molecular weight compounds evolving from the Rock-Eval<sup>®</sup> device condense in the vacuum lines and are not trapped in the sampling vials. The recovery factor is most likely proportional to the boiling point of a compound under vacuum.

The system was also tested to investigate the hydrocarbons released during the Rock-Eval<sup>®</sup> Shale Play™ analysis of produced oil samples. A 39 °API oil was prepared following the same method used for the *n*-alkane standards and then thermally vaporized from 100 to 350 °C (Sh0 + Sh1 peaks) into the U-tube trap. The lightest molecular *n*-alkanes (15) are mainly released at the Sh0 temperature range (100 °C to 200 °C). Medium molecular weight *n*-alkanes (>C<sub>15</sub>) are released at both Sh0 and Sh1 temperature range (100 °C to 350 °C; Fig. 9). The trapped material was then transferred to the vacuum line system and re-trapped into a glass vial immersed in liquid nitrogen. A solvent extract of the sample vial was analyzed by GC-FID and compared to the initial oil composition (Fig. 9). Good recovery (~70 to 90%) of most of the low-molecular weight hydrocarbons released in the Sh0 and Sh1 temperature range is observed. For this oil sample, the percentage of the compound recovery is similar comparing to those obtained for pure *n*-alkane samples (i.e. comprises to 70% and 90%). The observed losses are mainly with the heaviest compounds (>C<sub>15</sub>). This behavior is probably due to the retention of the high-molecular weight compounds in the dual vacuum on-line system. It should be noted that some of the hydrocarbons between C<sub>18</sub> and C<sub>23</sub> are missing (Fig. 9). This is

probably related to the imposed plateaus at 200 °C for 3 min to obtain a better separation of Sh0 and Sh1 peaks during the Rock-Eval® Shale Play™ analysis. Nevertheless, the GC analysis of the recovered oil fraction provides a good qualitative assessment and characterization of the low and high-molecular thermovaporized compounds (32).

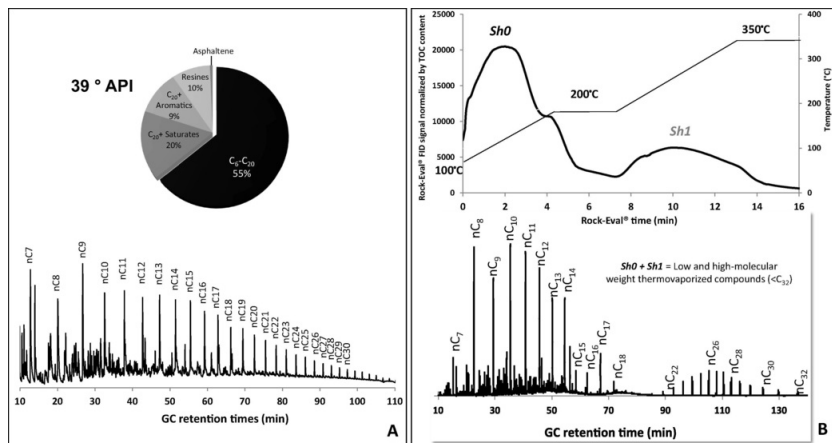

**Fig. 9** (A) Initial oil composition from SARA and GC traces. (B) Rock-Eval® FID normalized by TOC versus the composition of most compounds released from 100 to 350 °C and then recovered in liquid phase by the dual vacuum and on-line system coupled to a Rock-Eval® device - Application to an oil sample showing 39°API.

## 4 Conclusions

A dual vacuum and on-line system was developed to recover and identify compounds thermally released during a Rock-Eval® analysis of liquid and solid samples. This system was developed to provide from the analyzed sample both the Rock-Eval® Shale Play™ parameters and the thermal vaporized (100–350 °C) materials for subsequent off-line molecular and isotopic analysis. Test results indicate that a quantitative recovery is possible for thermovaporized low molecular weight compounds (Sh0) and good recoveries for the less volatile species (Sh1). No isotopic fractionation is evident in CO<sub>2</sub> evolved from carbonates prepared using Rock-Eval® suggesting that the coupled Rock-Eval® vacuum line recovery system is suitable for both carbon isotopic measurements on recovered gas species and molecular characterization of thermovaporized compounds.

The described recovery system can be used to characterize a wide of geologic solid and liquid samples including source and reservoir rocks containing natural petroleum or contaminated with drilling additives and various petroleum products. Although Rock-Eval® device was primarily developed to investigate sedimentary rocks and kerogens from the perspectives of petroleum industry, this analytical technique has been increasingly used in other geo-applications including: (1) the characterization of organic matter in soils (e.g., Di-Giovanni et al., 2000; Disnar et al., 2003; Hetényi et al., 2005; Sebag et al., 2006; Graz et al., 2012; Saenger et al., 2013; Hétényi and Nyilas, 2014); (2) the study of recent lacustrine sediments (e.g., Campy et al., 1994; Di-Giovanni et al., 1998; Meyers and Lallier-Vergès, 1999; Ariztegui et al., 2001; Steinmann et al., 2003; Jacob et al., 2004; Sanei et al., 2005; Boussafir et al., 2012; Zocatelli et al., 2012; Lavrieux et al., 2013; Sebag et al., 2013); and (3) the evaluation of recent marine sediments (e.g., Peters and Simoneit, 1982; Hussain and Warren, 1991; Calvert et al., 1992; Combourieu-Nebout et al., 1999; Ganeshram et al., 1999; Ozelik and Altunsoy, 2000; Holtvoeth et al., 2001, 2003, 2005; Tamburini et al., 2003; Baudin et al., 2007, 2010; Kim et al., 2007; Marchand et al., 2008; Tribouillard et al., 2008, 2009; Biscara et al., 2011; Riboulleau et al., 2011; Hare et al., 2014; Hatcher et al., 2014). Additional testing is needed to determine the applicability of the coupled Rock-Eval® - vacuum and on-line recovery system to these types of samples and (replace and by as) well as for material studies in other disciplines.

## Declaration of Competing Interest

The authors declare that they have no known competing financial interests or personal relationships that could have appeared to influence the work reported in this paper.

## Acknowledgements

We would like to thank the IFP Energies Nouvelles for providing approval to publish the cited patent 19/07457. H. Vermesse, P. Ekambas, I. Leveque and H. Ravelojaona from IFPEN are acknowledged for technical assistance. The editor Clifford Walters and the two reviewers Hebert Volk and Sedat Inan are deeply acknowledged for useful and constructive comments on the manuscript.

## References

- Abrams M., Gong C., Garnier C. and Sephton M., A new thermal extraction protocol to evaluate liquid rich unconventional oil in place and in-situ fluid chemistry, *Marine and Petroleum Geology* **88**, 2017, 659-675.
- Ariztegui D., Chondrogianni C., Lami A., Guilizzoni P. and Lafargue E., Lacustrine organic matter and the Holocene paleoenvironmental record of Lake Albano (central Italy), *Journal of Paleolimnology* **26**, 2001, 283-292.
- Baudin F., Combourieu-Nebout N. and Zahn R., Organic signatures of rapid climatic changes in Western Mediterranean during North Atlantic cold events of the Last Glacial, *Bulletin Société Géologique de France* **178**, 2007, 3-13.
- Baudin F., Disnar J.R., Martinez P. and Dennielou B., Distribution of the organic matter in the channel-levees systems of the Congo mud-rich deep sea fan (West Africa). Implication for deep offshore petroleum source rocks and global carbon cycle, *Marine and Petroleum Geology* **27**, 2010, 995-1010.
- Behar F., Vandenbroucke M., Tang Y., Marquis F. and Espitalié J., Thermal cracking of kerogen in open and closed systems, *Organic Geochemistry* **26**, 1997, 321-339.
- Behar F., Beaumont V.I. and Penteado H.L. De B., Rock-Eval 6 technology: performances and developments, *Oil & Gas Science and Technology* **56**, 2001, 111-134.
- Biscara L., Mulder T., Martinez P., Baudin F., Etcheber H., Jouanneau J.M. and Garlan T., Transport of terrestrial organic matter in the Ogooué deep sea turbidite system (Gabon), *Marine and Petroleum Geology* **28**, 2011, 1061-1072.
- Boussafir M., Sifeddine A., Jacob J., Foudi M., Cordeiro R.C., Albuquerque A.L.S., Abrao J.J. and Turcq B., Petrographical and geochemical study of modern lacustrine sedimentary organic matter (Lagoa do Caco, Maranao, Brazil): relationship between early diagenesis, organic sedimentation and lacustrine filling, *Organic Geochemistry* **47**, 2012, 88-98.
- Calvert S.E., Bustin R.M. and Pedersen T.S., Lack of evidence for enhanced preservation of sedimentary organic-matter in the oxygen minimum of the Gulf of California, *Geology* **20**, 1992, 757-760.
- Campy M., Bichet V., Di-Giovanni C., Richard H., Richard J. and Olive P., Evolution of the matter fluxes since 12,000 years in the high Doubs valley (France), *Bulletin de la Société Géologique de France* **165**, 1994, 381-400.
- Combourieu-Nebout, N., Londeix, L., Baudin, F., Turon, J.L., 1999. Quaternary marine and continental paleoenvironments in the western Mediterranean (Site 976, Alboran Sea): palynological evidences. In: Zahn, R., Comas, M.C., Klaus, A. (Eds.), Proceedings ODP Scientific Results 161, pp. 457-468.
- Di-Giovanni C., Disnar J.R., Bichet V., Campy M. and Guillet B., Geochemical characterization of soil organic matter and variability of a postglacial detrital organic supply (Chaillexon Lake, France), *Earth Surface Processes and Landforms* **23**, 1998, 1057-1069.
- Di-Giovanni C., Disnar J.R., Bakyono J.P., Kéravis D., Millet F. and Olivier J.E., Determination of eroded geological formations using organic matter characterization (Moulin basin, Alpes-de-Haute-Provence, France), *Comptes Rendus Académie des Sciences Série II* **331**, 2000, 7-14.
- Disnar J.R., Guillet B., Keravis D., Di-Giovanni C. and Sebag D., Soil organic matter (SOM) characterization by Rock-Eval pyrolysis: scope and limitations, *Organic Geochemistry* **34**, 2003, 327-343.
- Duemichen E., Eisentraut P., Celina M. and Braun U., Automated thermal extraction-desorption gas chromatography mass spectrometry: A multifunctional tool for comprehensive characterization of polymers and their degradation products, *Journal of Chromatography A* **1592**, 2019, 133-142.
- Espitalié J., Laporte J.L., Madec M., Marquis F., Leplat P., Paulet J. and Boutefeu A., Méthode rapide de caractérisation des roches mères, de leur potentiel pétrolier et de leur degré d'évolution, *Oil and Gas Science and Technology* **32**, 1977, 23-42.
- Espitalié J., Deroo G. and Marquis F., La pyrolyse Rock-Eval et ses applications, *Revue de l'Institut Français du Pétrole* **41**, 1986, 73-89.
- Ganeshram R.S., Calvert S.E., Pedersen T.F. and Cowie G.L., Factors controlling the burial of organic carbon in laminated and bioturbated sediments off NW Mexico: implications for hydrocarbon preservation, *Geochimica e Cosmochimica Acta* **63**, 1999, 1723-1734.
- Graz Y., Di-Giovanni C., Copard Y., Mathys N., Cras A. and Marc V., Annual fossil organic carbon delivery due to mechanical and chemical weathering of marly badlands areas, *Earth Surface Processes and Landforms* **37**, 2012, 1263-1271.
- Hare A.A., Kuzyk Z.Z.A., Macdonald R.W., Sanei H., Barber D., Stern G.A. and Wang F.Y., Characterization of sedimentary organic matter in recent marine sediments from Hudson Bay, Canada, by Rock-Eval pyrolysis, *Organic*

*Geochemistry* **68**, 2014, 52-60.

- Harshman S.W., Rubenstein M.H., Qualley A.V., Fan M., Geier B.A., Pitsch R.L., Slusher G.M., Hughes G.T., Dershem V.L., Grigsby C.C., Ott D.K. and Martin J.A., Evaluation of thermal desorption analysis on a portable GC-MS system, *International Journal of Environmental Analytical Chemistry* **97**, 2017, 247-263.
- Hatcher P., Ravin A., Behar F. and Baudin F., Diagenesis of organic matter in a 400 m organic rich sediment core from offshore Namibia using solid state <sup>13</sup>C NMR and FTIR, *Organic Geochemistry* **75**, 2014, 8-23.
- Hetényi M., Nyilas T. and Toth T.M., Stepwise Rock-Eval pyrolysis as a tool for typing heterogeneous organic matter in soils, *Journal of Analytical and Applied Pyrolysis* **74**, 2005, 45-54.
- Hetényi M. and Nyilas T., Soil organic matter characterization using S3 and S4 signals from Rock-Eval pyrolysis, *Pedosphere* **24**, 2014, 563-574.
- Holtvoeth J., Kolonic S. and Wagner T., Soil organic matter as an important contributor to late Quaternary sediments of the tropical West African continental margin, *Geochimica et Cosmochimica Acta* **69**, 2005, 2031-2041.
- Holtvoeth J., Wagner T., Horsfield B. and Schubert C., Organic matter in riverinfluenced continental margin sediments: the land-ocean and climate linkage at the Late Quaternary Congo fan (ODP Site 1075), *Geochemistry Geophysics Geosystem* **4**, 2003, <https://doi.org/10.1029/2003GC000590>.
- Holtvoeth J., Wagner T., Horsfield B., Schubert C. and Wand U., Late Quaternary supply of terrigenous organic matter to the Congo deep sea fan (ODP site 1075): Implications for equatorial African paleoclimate, *Geo-Marine Letters* **21**, 2001, 23-33.
- Hussain M. and Warren J.K., Source rock potential of shallow-water evaporates - an investigation in Holocene-Pleistocene salt flat sabkha (playa), West Texas New-Mexico, *Carbonates and Evaporites* **6**, 1991, 217-224.
- Inan S., Qathami S., Zahrani M. and Alsoaie M., Thermo-vaporization for decontaminating hydrocarbon source rocks, *International Journal of Coal Geology* **189**, 2018, 111-121.
- Jacob J., Disnar J.R., Boussafir M., Sifeddine A., Turcq B. and Albuquerque A.L.S., Major environmental changes recorded by lacustrine sedimentary organic matter since the last glacial maximum near the equator (Lagoa do Caco, NE Brazil), *Palaeogeography, Palaeoclimatology, Palaeoecology* **205**, 2004, 183-197.
- Kano H., Okamoto T., Kitagawa S., Iiguni Y., Ohtani H., Ito H., Iwaia K. and Kuno M., A novel analytical pyrolysis device applicable for measurements of less volatile pyrolyzates, *Journal of Analytical and Applied Pyrolysis* **113**, 2015, 165-173.
- Kim J.H., Park M.H., Tsunogai U., Cheong T.J., Ryu B.J., Lee Y.J., Han H.C., Oh J.H. and Chang H.W., Geochemical characterization of the organic matter, pore water constituents and shallow methane gas in the eastern part of the Ulleung Basin, East Sea (Japan Sea), *Island Arc* **16**, 2007, 93-104.
- King G.M., Kostka J.E., Hazen T.C. and Sobczyk P.A., Microbial responses to the Deepwater Horizon oil spill: from coastal wetlands to the deep sea, *Annual Review of Marine Science* **7**, 2015, 377-401.
- Lafargue E., Marquis F. and Pillot D., Rock-Eval 6 applications in hydrocarbon exploration, production and soils contamination studies, *Oil and Gas Science and Technology* **53**, 1998, 421-437.
- Larter S.R. and Douglas A.G., Pyrolysis methods in organic geochemistry: an overview, *Journal of Analytical and Applied Pyrolysis* **4**, 1982, 1-19.
- Larter S.R. and Horsfield B., Determination of structural components of kerogens by the use of analytical pyrolysis methods, In: Engel M.H. and Macko S.A., (Eds.), *Organic Geochemistry: Principles and Applications*, 1993, Springer, 271-287.
- Lattimer R.P., Direct analysis of polypropylene compounds by thermal desorption and pyrolysis-mass spectrometer, *Journal of Analytical and Applied Pyrolysis* **26**, 1993, 65-92.
- Lavrieux M., Disnar J.R., Chapron E., Bréhéret J.G., Jacob J., Miras Y., Reyss J.L., Andrieu-Ponel V. and Arnaud F., A 6700 yr sedimentary record of climatic and anthropogenic signals in Lake Aydat (French Massif Central), *Holocene* **23**, 2013, 1317-1328.
- Leinweber P. and Schulten H.-R., Advances in analytical pyrolysis of soil organic matter, *Journal of Analytical and Applied Pyrolysis* **49**, 1999, 359-383.
- Marchand C., Lallier-Vergès E., Disnar J.R. and Kéravis D., Organic carbon sources and transformations in mangrove sediments: a Rock-Eval pyrolysis approach, *Organic Geochemistry* **39**, 2008, 408-421.
- Meyers P.A. and Lallier-Vergès E., Lacustrine sedimentary organic matter records of Late Quaternary paleoclimates, *Journal of Paleolimnology* **21**, 1999, 345-372.

- Nuelle M., Dekiff J.H., Remy D. and Fries E., A new analytical approach for monitoring microplastics in marine sediments, *Environmental Pollution* **184**, 2014, 161-169.
- Nsafu F., Collard F.-X., Carrier M. and Gorgens J., Lignocellulose pyrolysis with condensable volatiles quantification by thermogravimetric analysis-thermal desorption/gas chromatography-mass spectrometry method, *Journal of Analytical and Applied Pyrolysis* **116**, 2015, 86-95.
- Otto S., Streibel T., Erdmann S., Klingbeil S., Schulz-Bull D. and Zimmermann R., Pyrolysis-gas chromatography-mass spectrometry with electron ionization or resonance-enhanced-multi-photon-ionization for characterization of polycyclic aromatic hydrocarbons in the Baltic Sea, *Analytica Chimica Acta* **885**, 2015, 60-69.
- Ozcelik O. and Altunsoy M., Organic facies characteristics of quaternary sediments, Gulf of Izmit, Marmara Sea, Turkey, *International Geology Review* **42**, 2000, 1017-1029.
- Pillot D., Deville E. and Prinzhofer A., Identification and quantification of carbonates species using Rock-Eval pyrolysis, *Oil and Gas Science and Technology* **69**, 2014, 341-349.
- Peters K.E. and Simoneit B.R.T., Rock-Eval pyrolysis of Quaternary sediments from leg-64, site 479 and site 480, Gulf of California, *Initial Reports of the Deep Sea Drilling Project* **64**, 1982, 925-931.
- Riboulleau A., Tribouillard N., Baudin F., Bout-Roumaizeilles V. and Lyons T., Unexpectedly low organic matter content in Cariaco Basin sediments during the Younger Dryas: origin and implications, *Comptes Rendus Geosciences* **343**, 2011, 351-359.
- Rios Mendoza L.M. and Balcer M., Microplastics in freshwater environments: a review of quantification assessment, *TrAC Trends in Analytical Chemistry* **113**, 2019, 402-408.
- Romero-Sarmiento, M.-F., Pillot, D., Letort, G., Lamoureux-Var, V., Beaumont, V., Huc, A.-Y., Garcia, B., 2014. New Rock-Eval method for characterization of shale plays. In: 14th Latin American Congress on Organic Geochemistry (ALAGO). Buzios, Rio de Janeiro - Brazil.
- Romero-Sarmiento M.-F., Euzen T., Rohais S., Jiang C. and Littke R., Artificial thermal maturation of source rocks at different thermal maturity levels: application to the Triassic Montney and Doig formations in the Western Canada Sedimentary Basin, *Organic Geochemistry* **97**, 2016a, 148-162.
- Romero-Sarmiento M.-F., Pillot D., Letort G., Lamoureux-Var V., Beaumont V., Huc A.-Y. and Garcia B., New Rock-Eval method for characterization of unconventional shale resource systems, *Oil & Gas Science and Technology* **71**, 2016b, <https://doi.org/10.2516/ogst/2015007>.
- Romero-Sarmiento M.-F., Ramiro-Ramirez S., Berthe G., Fleury M. and Littke R., Geochemical and petrophysical source rock characterization of the Vaca Muerta Formation, Argentina: implications for unconventional petroleum resource estimations, *International Journal of Coal Geology* **184**, 2017, 27-41.
- Romero-Sarmiento M.-F., A quick analytical approach to estimate both free versus sorbed hydrocarbon contents in liquid rich source rocks, *American Association of Petroleum Geologists Bulletin* **103**, 2019, 2031-2043.
- Romero-Sarmiento, M.-F., Cadeau, P., Sissmann, O., Beaumont, V., 2019. Système et procédé pour la détermination de la composition chimique des composés contenus dans un échantillon. IFPEN Patent 19/07457 deposited July 4.
- Rosenheim B.E., Santoro J.A., Gunter M. and Domack E.W., Improving Antarctic sediment <sup>14</sup>C dating using ramped pyrolysis: an example from the Hugo Island trough, *Radiocarbon* **55**, 2013, 115-126.
- Saenger A., Cecillon L., Sebag D. and Brun J.J., Soil organic carbon quantity, chemistry and thermal stability in a mountainous landscape: a Rock-Eval pyrolysis survey, *Organic Geochemistry* **54**, 2013, 101-114.
- Sanei H., Stasiuk L.D. and Goodarzi F., Petrological changes occurring in organic matter from recent lacustrine sediments during thermal alteration by Rock-Eval pyrolysis, *Organic Geochemistry* **36**, 2005, 1190-1203.
- Seeley M.E., Wang Q., Bacosa H., Rosenheim B. and Liu Z., Environmental petroleum pollution analysis using ramped pyrolysis-gas chromatography-mass spectrometry, *Organic Geochemistry* **124**, 2018, 180-189.
- Shultz J.M., Walsh L., Garfin D.R., Wilson F.E. and Neria Y., The 2010 Deepwater Horizon oil spill: the trauma signature of an ecological disaster, *The Journal of Behavioral Health Services and Research* **41**, 2014, 58-76.
- Sebag D., Disnar J.R., Guillet B., Di Giovanni C., Verrecchia E.P. and Durand A., Monitoring organic matter dynamics in soil profiles by 'Rock-Eval pyrolysis': bulk characterization and quantification of degradation, *European Journal of Soil Science* **57**, 2006, 344-355.
- Sebag D., Debret M., M'voubou M., Obame R.M., Ngomanda A., Oslisly R., Bentaleb I., Disnar J.R. and Giresse P., Coupled Rock-Eval pyrolysis and spectrophotometry for lacustrine sedimentary dynamics: application for West

Central African rainforests (Kamalete and Nguene lakes, Gabon), *Holocene* **23**, 2013, 1173-1183.

Steinmann P, Adatte T. and Lambert P, Recent changes in sedimentary organic matter from Lake Neuchatel (Switzerland) as traced by Rock-Eval pyrolysis, *Eclogae Geologicae Helveticae* **96**, 2003, 109-116.

Tamburini F, Adatte T, Follmi K., Bernasconi S.M. and Steinmann P, Investigating the history of East Asian monsoon and climate during the last glacial-interglacial period (0-140000 years): mineralogy and geochemistry of ODP Sites 1143 and 1144, South China Sea, *Marine Geology* **201**, 2003, 147-168.

Tang Y.C. and Stauffer M., Development of multiple cold trap pyrolysis, *Journal of Analytical and Applied Pyrolysis* **28**, 1994, 167-174.

Tribouillard N., Bout-Roumazeilles V., Algeo T., Lyons T.W., Sionneau T., Montero-Serrano J.C., Riboulleau A. and Baudin F., Paleodepositional conditions in the Orca Basin as inferred from organic matter and trace metal contents, *Marine Geology* **254**, 2008, 62-78.

Tribouillard N., Bout-Roumazeilles V., Sionneau T., Montero-Serrano J.C., Riboulleau A. and Baudin F., Organic-matter preservation and accumulation in an anoxic setting: the Orca Basin, Gulf of Mexico, *Comptes Rendus Geosciences* **341**, 2009, 1-9.

Volk H. and George S.C., Using petroleum inclusions to trace petroleum systems - a review, *Organic Geochemistry* **129**, 2019, 99-123.

Wilson M.J., Frickel S., Nguyen D., Bui T., Echsner S., Simon B.R., Howard J.L., Miller K. and Wickliffe J.K., A targeted health risk assessment following the Deepwater Horizon oil spill: polycyclic aromatic hydrocarbon exposure in Vietnamese-American shrimp consumers, *Environmental Health Perspectives* **152**, 2014, 152-159.

Yanagisawa H., Kudo Y., Nakagawa K., Miyagawa H., Maruyama F. and Fujimaki S., Simultaneous screening of major flame retardants and plasticizers in polymer materials using pyrolyzer/thermal desorption gas chromatography mass spectrometry (Py/TD-GC-MS), *Molecules* **23**, 2018, 728.

Zengel S., Bernik B.M., Rutherford N., Nixon Z. and Michel J., Heavily oiled salt marsh following the Deepwater Horizon oil spill, ecological comparisons of shoreline cleanup treatments and recovery, *PLoS One* **10**, 2015, 1-27.

Zhang Z., Volkman J.K., Xie X. and Snowdon L.R., Stepwise pyrolysis of the kerogen from the Huadian oil shale, NE China: algaenan-derived hydrocarbons and mid-chain ketones, *Organic Geochemistry* **91**, 2016, 89-99.

Zhang Z., Volkman J.K., Lu H. and Zhai C., Sources of organic matter in the Eocene Maoming oil shale in SE China as shown by stepwise pyrolysis of asphaltene, *Organic Geochemistry* **112**, 2017, 119-126.

Zocatelli R., Turcq B., Boussafir M., Cordeiro R.C., Disnar J.R., Costa R.L., Sifeddine A., Albuquerque A.L.S., Bernardes M.C. and Jacob J., Late Holocene paleoenvironmental changes in Northeast Brazil recorded by organic matter in lacustrine sediments of Lake Boqueirao, *Palaeogeography, Palaeoclimatology, Palaeoecology* **363**, 2012, 127-134.

## Appendix A. Supplementary material

The following are the Supplementary data to this article:

[Multimedia Component 1](#)

**Supplementary data 1**

---

### Highlights

- Development of an on-line recovery system coupled to a Rock-Eval® device.
- For one sample, Sh0 & Sh1 peaks, molecular and isotopic compositions are provided.
- Most released compounds were recovered by the dual vacuum and on-line system.
- The system can be used to characterize both solid and liquid samples.

---

## Queries and Answers

**Query:** Your article is registered as a regular item and is being processed for inclusion in a regular issue of the journal. If this is NOT correct and your article belongs to a Special Issue/Collection please contact p.johnson.2@elsevier.com immediately prior to returning your corrections.

**Answer:** Yes

**Query:** The author names have been tagged as given names and surnames (surnames are highlighted in teal color). Please confirm if they have been identified correctly.

**Answer:** Yes

**Query:** Correctly acknowledging the primary funders and grant IDs of your research is important to ensure compliance with funder policies. We could not find any acknowledgement of funding sources in your text. Is this correct? /

**Answer:** IFP Energies Nouvelles provided financial support for the postdoctoral research of Pierre Cadeau 2018- 2019.