



HAL
open science

Gas-Solid Injection in Fluidized Beds for Biomass Wastes Valorization

Lucas Massaro Sousa, Benjamin Amblard, Sina Tebianian

► **To cite this version:**

Lucas Massaro Sousa, Benjamin Amblard, Sina Tebianian. Gas-Solid Injection in Fluidized Beds for Biomass Wastes Valorization. 15th International Conference on Industrial Applications of Computational Fluid Dynamics, SINTEF, Jun 2024, Trondheim (Norvège), Norway. hal-04696192

HAL Id: hal-04696192

<https://ifp.hal.science/hal-04696192v1>

Submitted on 12 Sep 2024

HAL is a multi-disciplinary open access archive for the deposit and dissemination of scientific research documents, whether they are published or not. The documents may come from teaching and research institutions in France or abroad, or from public or private research centers.

L'archive ouverte pluridisciplinaire **HAL**, est destinée au dépôt et à la diffusion de documents scientifiques de niveau recherche, publiés ou non, émanant des établissements d'enseignement et de recherche français ou étrangers, des laboratoires publics ou privés.

Gas-Solid Injection in Fluidized Beds for Biomass Wastes Valorization

Lucas Massaro Sousa, Benjamin Amblard, Sina Tebianian

IFP Energies nouvelles, Rond-point de l'échangeur de Solaize, BP 3, 69360 Solaize, France

Abstract

The processing of biomass and biomass wastes towards renewable energy and green fuels plays an important role for the decarbonisation of global economy and mitigation of climate change. The injection of solid fuels into fluidized bed reactors for thermochemical conversion is challenging due to the inherent complexity of the multiphase system, related to the fast gas-solid transport and jet interaction with bed bubbles. Ultimately, solid feeding impacts on process reliability, conversion efficiency and design robustness. In this study, the gas-solid transport and pneumatic injection in gas-solid systems was investigated. A pressurized air feeder was used to inject a batch of sawdust powders into fixed and fluidised beds at lab scale. First, the horizontal feeder was characterised as a function of the operating parameters (feeder pressure, secondary gas velocity, initial biomass content), which showed an impact on the solids flux and flow concentration. Then, these parameters were used to define a transport regime operation map for the injection line. The experimental results were used to evaluate the CPFD approach MP-PIC (Multiphase Particle in Cell) with the software Barracuda™. The gas-solid transport simulations under different feeder operating conditions showed a fair agreement with the experimental results, in terms of solids flux and flow concentration. Finally, different tracking techniques (fluorescent particle tracking, pitot tubes, and electric capacitance tomography, ECVT) were used and compared to assess the penetration and dispersion of the biomass into fixed and fluidized beds. The jet propagation was captured with transient/3D images with the ECVT, and the biomass concentration across the jet length was quantified with the fluorescent particle tracking technique. Similar jet penetration lengths were obtained with the different techniques, and it was generally more under higher solids flux from the injector. Ultimately, the pros and cons of each tracking technique were highlighted.

Keywords: Multiphase Flow, Biomass Waste, Pneumatic Conveying, ECVT

Conference Section: Fluidized beds

Graphical Abstract

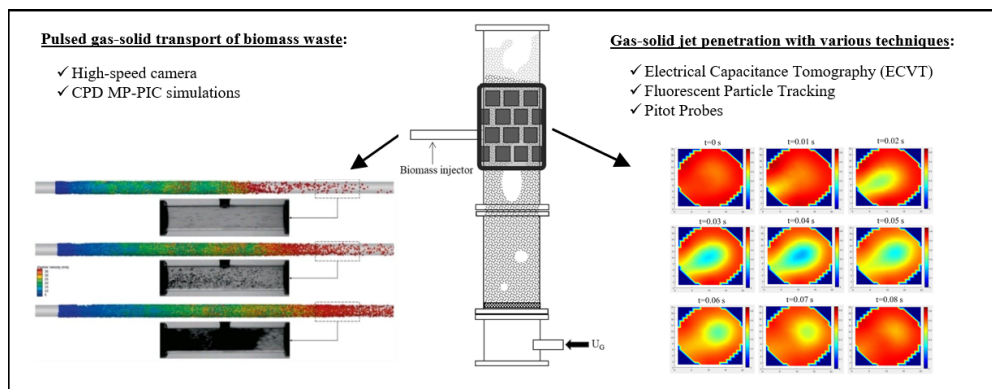

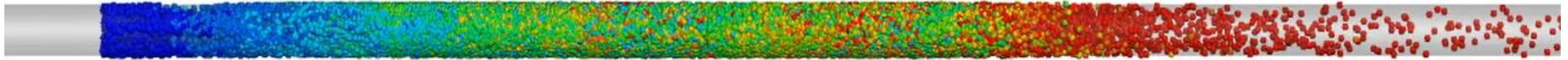

GAS-SOLID INJECTION IN FLUIDIZED BEDS FOR BIOMASS WASTES VALORIZATION

LUCAS MASSARO SOUSA, BENJAMIN AMBLARD, SINA TEBIANIAN

11/06/24

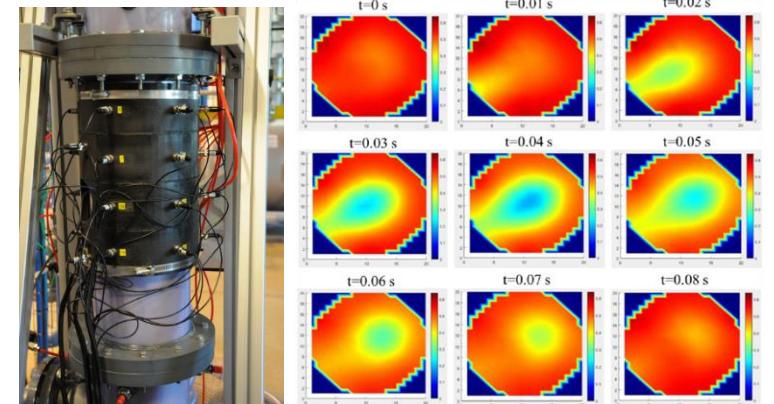
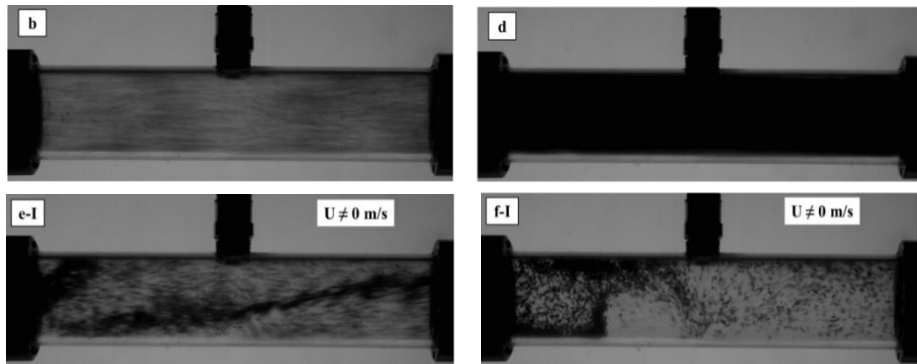

IFP NEW ENERGY (IFPEN)

- French research center active in the fields of environment and circular economy, renewable energy, recycling, sustainable mobility and responsible oil and gas.



RESEARCH MOTIVATION

- Waste biomass as a renewable feedstock for thermochemical processes (pyrolysis, gazification, combustion...)
- Challenge of feeding waste biomass into fluidized bed reactors¹:
 - Unusual properties (size, shape, density, moisture, etc.)
- Performance of the conversion processes is linked to the solids injection system
- Pneumatic injection is interesting for an efficient fuel penetration and mixing



- Experimental and CFD investigation of the biomass injection (transport)
- Experimental investigation on biomass penetration in a fixed and fluidized bed

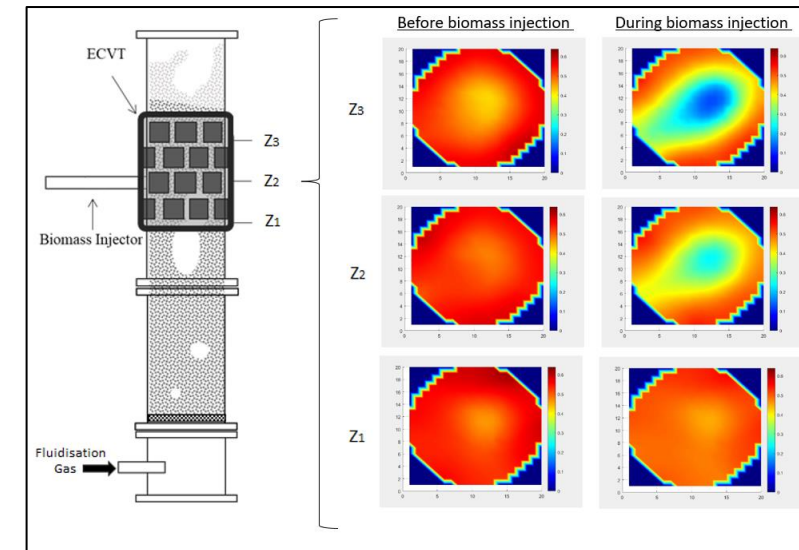
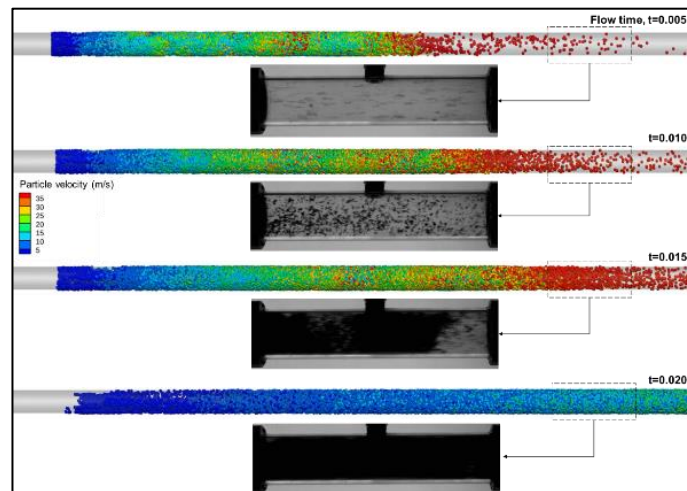
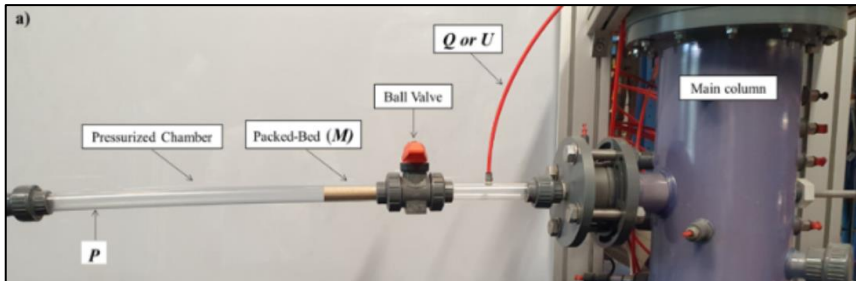

SYSTEM HYDRODYNAMICS: HIGH-SPEED IMAGING²

Renewable energies

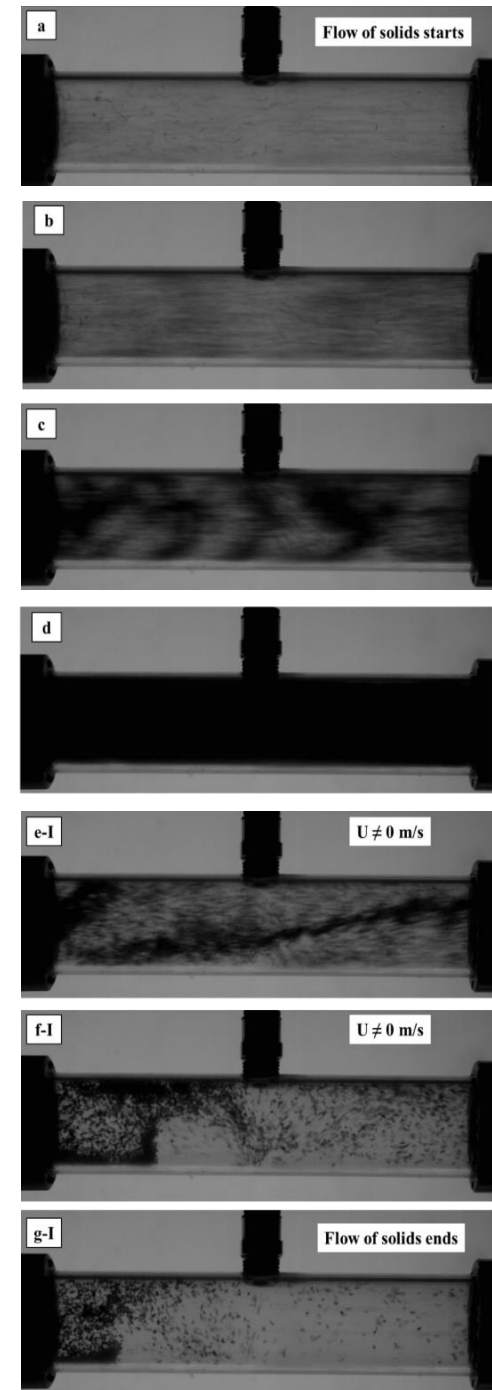
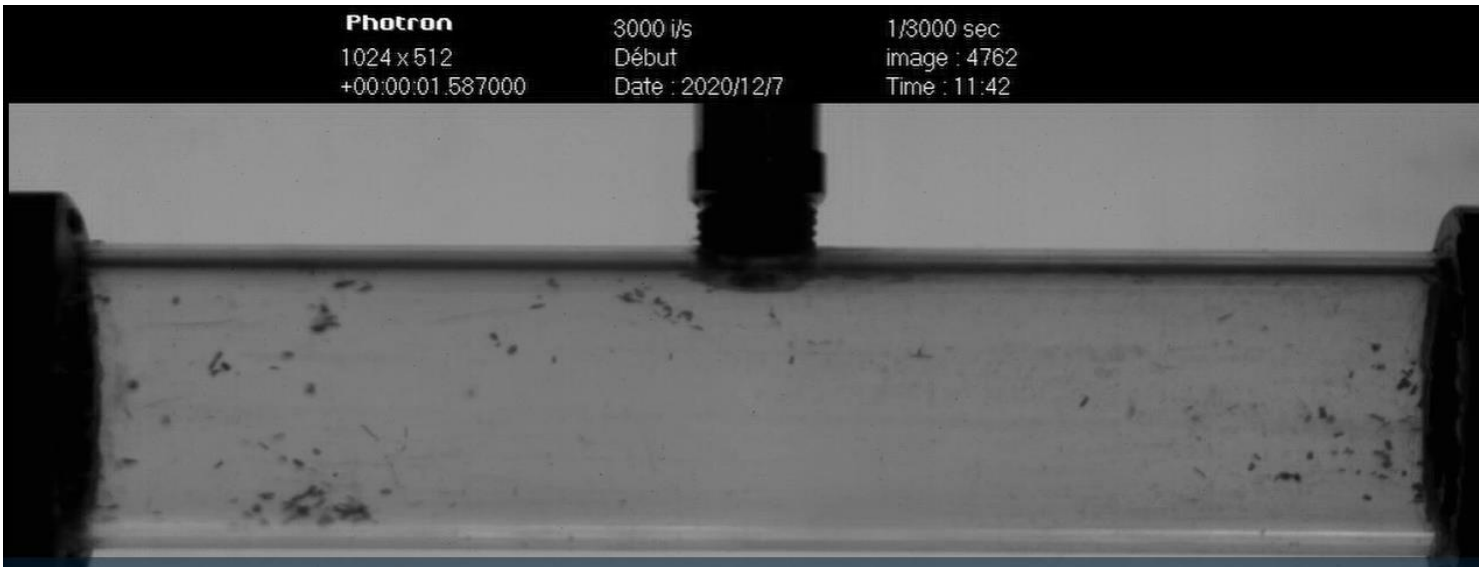
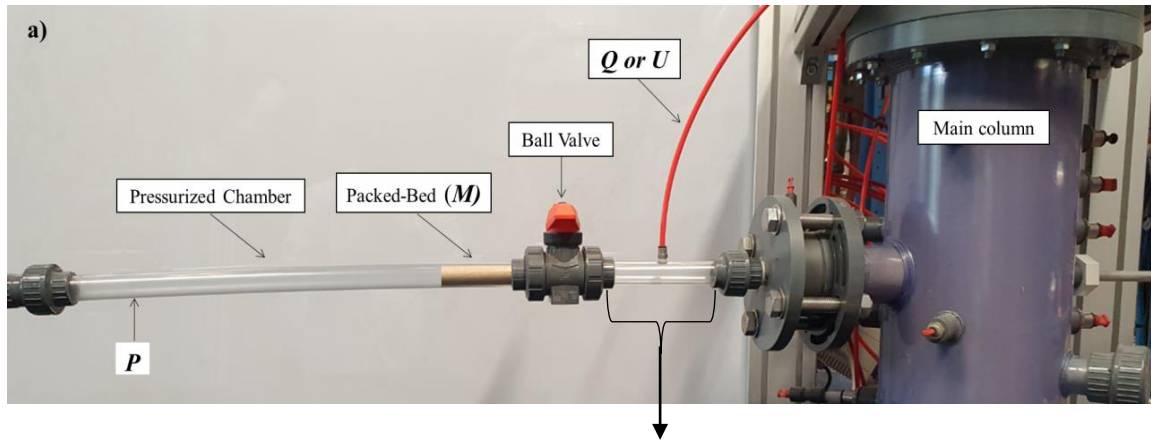

● Injection time scale for pulse from 0.05 to 0.20 s

SYSTEM HYDRODYNAMICS: EXPERIMENTAL OPERATION MAP²

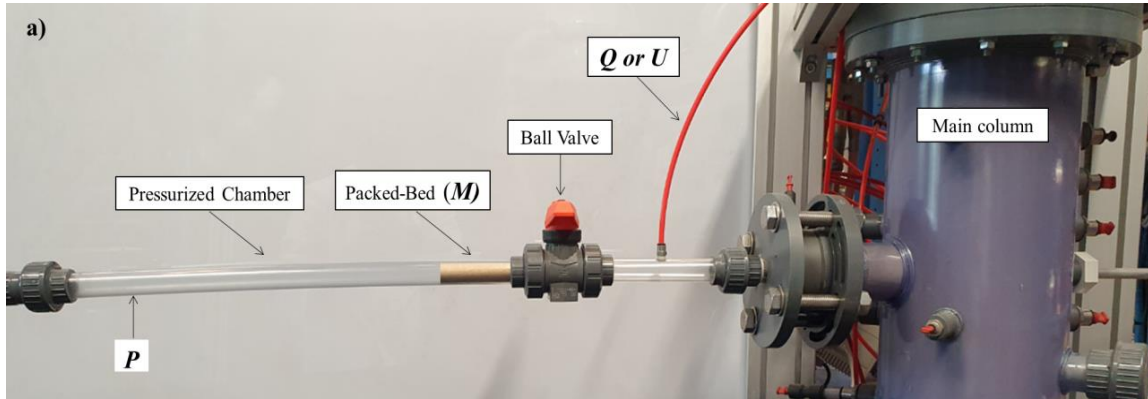

- $180 \leq P \leq 500$ kPa
- $3 \leq M \leq 26$ g
- $0 \leq U \leq 4.4$ m/s
- Sawdust $447 \leq d_{50} \leq 1130$ μm
- Single-phase unit ($0 \leq U_g \leq 0.77$ m/s)
- Fixed and Fluidized beds ($0 \leq U_g \leq 0.48$ m/s)

\uparrow
 U_g

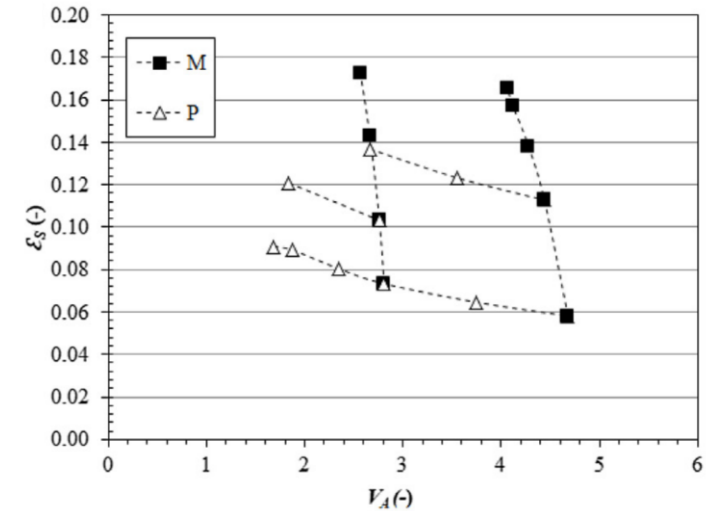
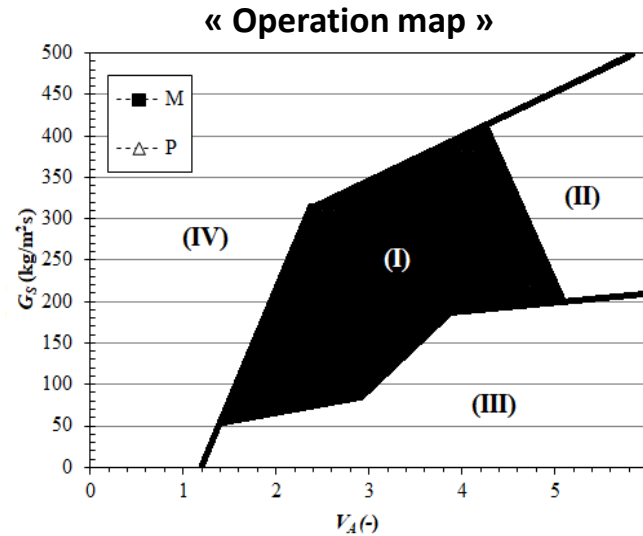
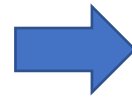
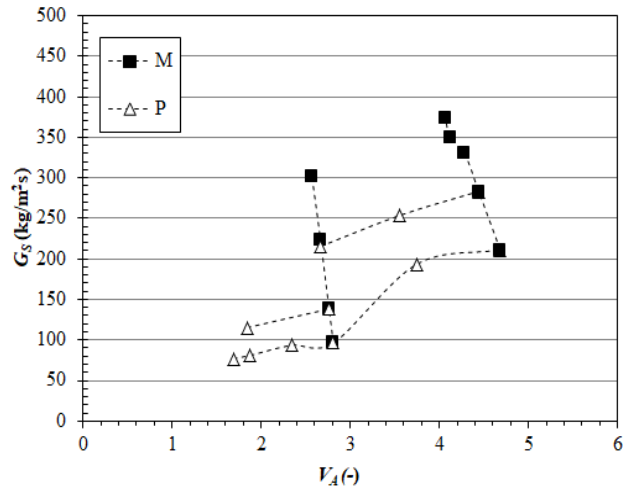

$$V_A = \frac{\left(V - \frac{M}{\rho_p} \right) \cdot \left(\frac{T_{ref}}{T} \right) \cdot \left(\frac{P}{P_{ref}} \right)}{v}$$

CONTEXT: CFD FOR GAS-PARTICLES FLOW: TWO FLUIDS MODEL

➤ Two fluid models of interest in this PhD projet (Gas phase = classic eulerian approach)

➤ Approach 1 for solid phase: Euler with Kinetic Theory of Granular Flow (KTGF), OpenFOAM

- Solid phase represented with a single diameter → use of a representative diameter
- Complex particles interactions modeling

Momentum variation

$$\frac{\partial(\alpha_s \rho_s \vec{u}_s)}{\partial t} + \nabla \cdot (\alpha_s \rho_s \vec{u}_s \vec{u}_s) = \underbrace{-\alpha_s \nabla P}_{\text{pressure}} + \underbrace{\nabla P_s}_{\text{Solid pressure}} + \underbrace{\alpha_s \rho_s \vec{g}}_{\text{gravity}} + \underbrace{\nabla(\tau_s)}_{\text{Solid stress tensor}} + \underbrace{K_d(\vec{u}_s - \vec{u}_g)}_{\text{Gas/particles interactions}}$$

$\mu_s, \lambda_s, P_s = f(\text{granular temperature } \theta_s)$ $\theta_s = \frac{1}{3} \langle u'_s \rangle^2 \longrightarrow$ Transport equation

Solid stress tensor **Solid viscosity**

$$\tau_s = \mu_s (\nabla \vec{u}_s + \nabla^T \vec{u}_s) + \left(\lambda_s - \frac{2}{3} \mu_s \right) \nabla \cdot \vec{u}_s I$$

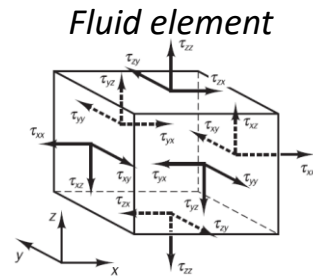

➤ Approach 2 for solid phase: Euler with Multiphase Particle In Cell (MP-PIC), Barracuda VR

- Particle Size Distribution represented (transport of a distribution function $f(x, u_p, m, t)$)
- Simpler particles interactions modeling

Momentum variation

$$\frac{\partial(\alpha_s \rho_s \vec{u}_s)}{\partial t} + \nabla \cdot (\alpha_s \rho_s \vec{u}_s \vec{u}_s) = \underbrace{-\alpha_s \nabla P}_{\text{pressure}} + \underbrace{\nabla P_s}_{\text{Solid pressure}} + \underbrace{\alpha_s \rho_s \vec{g}}_{\text{gravity}} + \underbrace{\nabla \left[\iint f m (\vec{u}_p - \vec{u}_s) (\vec{u}_p - \vec{u}_s) dm du_p \right]}_{\text{Solid stress tensor}} + \underbrace{\iint f m K_d (\vec{u}_g - \vec{u}_p) dm du_p}_{\text{Gas/particles interactions}}$$

$\alpha_s = \iint f \frac{m}{\rho_s} dm du_p$ $\vec{u}_s = \frac{1}{\alpha_s \rho_s} \iint f m \vec{u}_p dm du_p$ $f(x, m, d, v) \longrightarrow$

$x1, m1, d1, v1$ $x2, m2, d2, v2$ $x3, m3, d3, v3$ \dots xn, mn, dn, vn

$P_s = Cst * \frac{\alpha_s^\beta}{\max[(\alpha_{s,max} - \alpha_s), \epsilon_{barracuda}(1 - \alpha_s)]}$

CFD SIMULATION³

- Hybrid Euler-Lagrange (MP-PIC approach) with Barracuda



- Operating conditions and mesh:

Experimental conditions	P (kPa)	M (kg)	V_S/V_A (-)	t_e (s)	G_S (kg·m ⁻² ·s ⁻¹)	ϵ_S (-)	R (%)
	500	0.012	0.0152	0.134	284	0.113	0.9

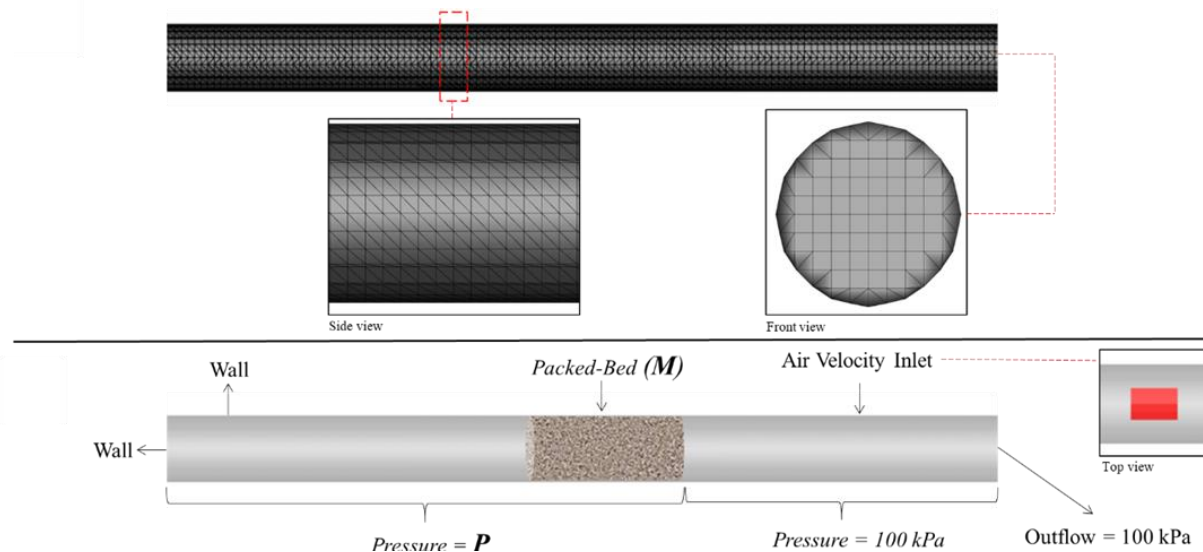

- PSD, particle density 1030 kg/m³, bulk density 215 kg/m³

- Drag models

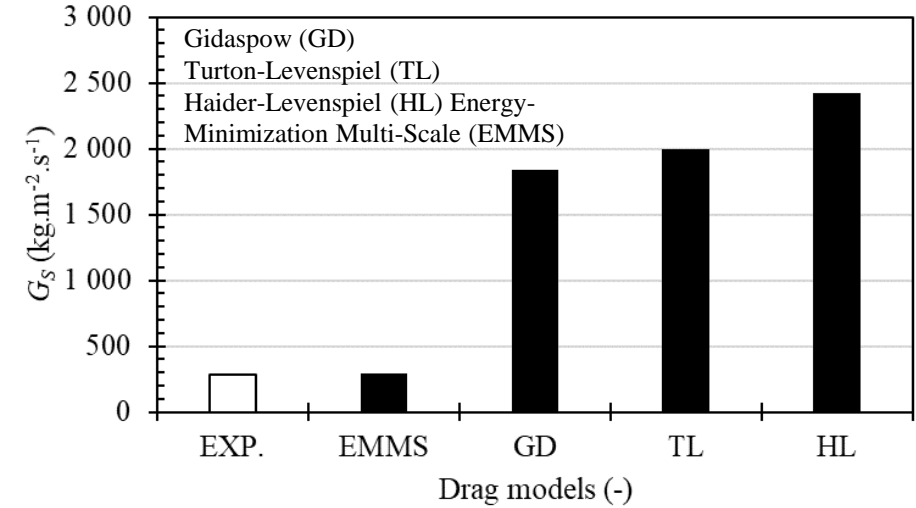

- Particle-to-wall interaction

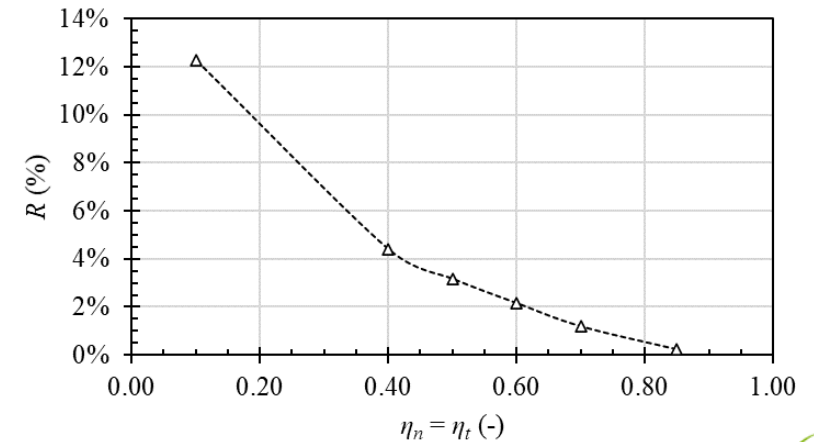

TRANSIENT CFD HYDRODYNAMICS CONTOURS

Particle Volume Fraction

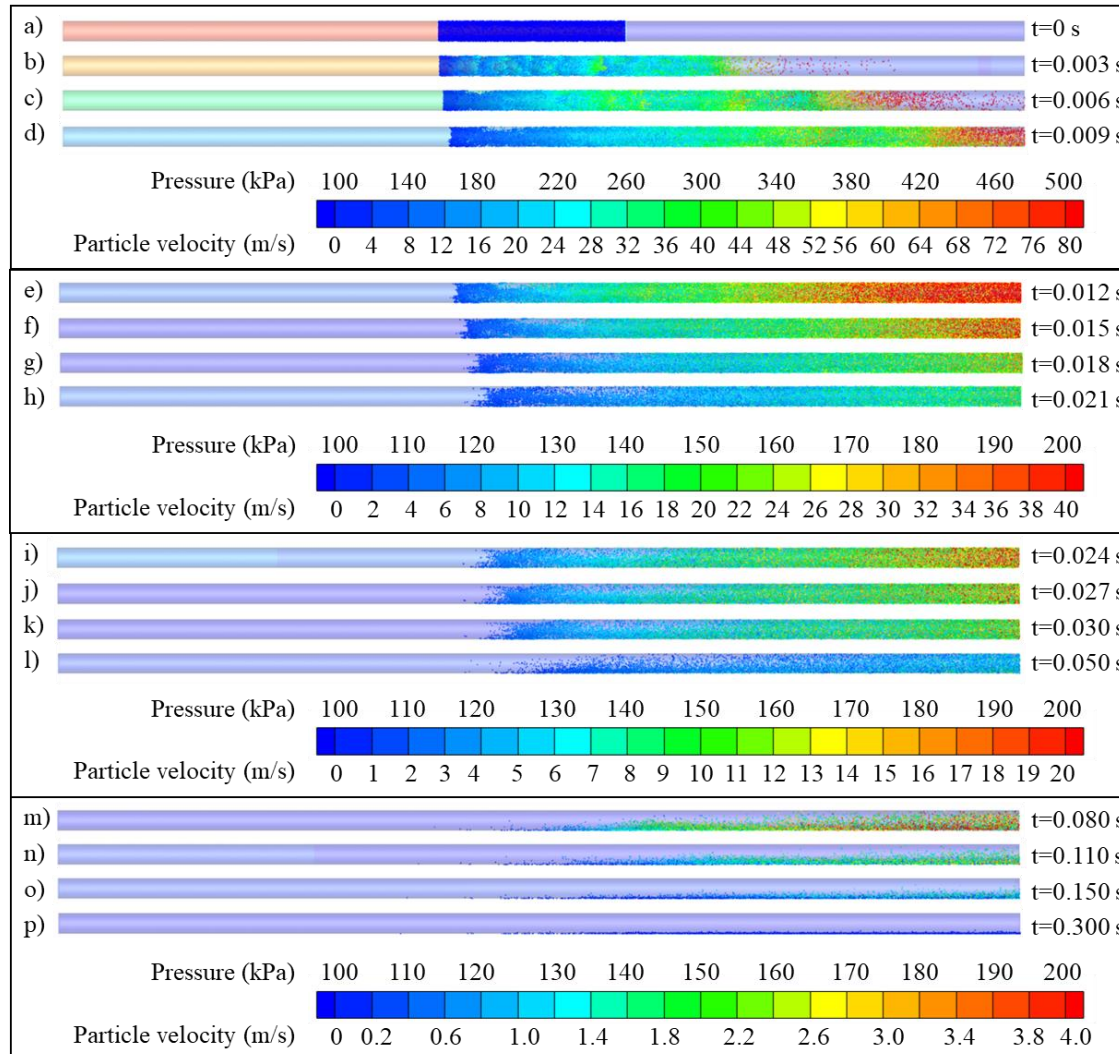
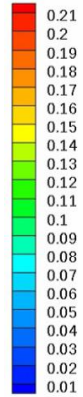

Massaro Sousa et al. Chem. Eng. Sci. 255, 2022



QUALITATIVE COMPARISON WITH EXPERIMENTS

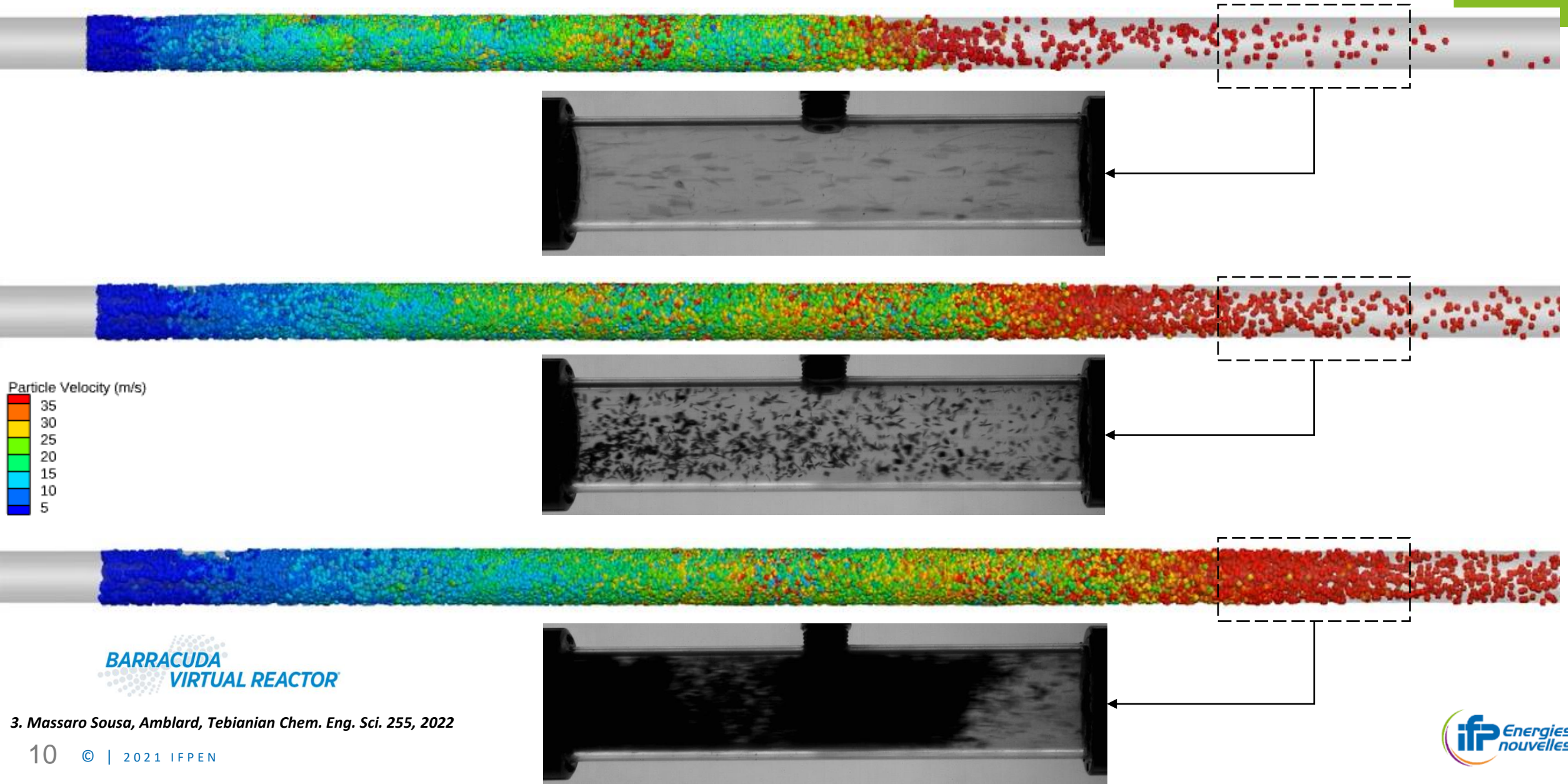

BARRACUDA
VIRTUAL REACTOR

3. Massaro Sousa, Amblard, Tebianian Chem. Eng. Sci. 255, 2022

QUANTITATIVE COMPARISON WITH EXPERIMENTS³

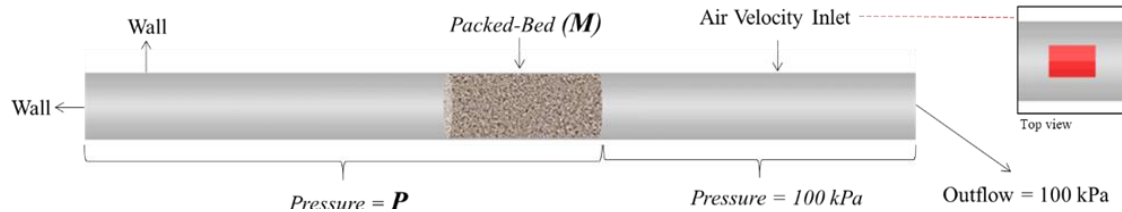
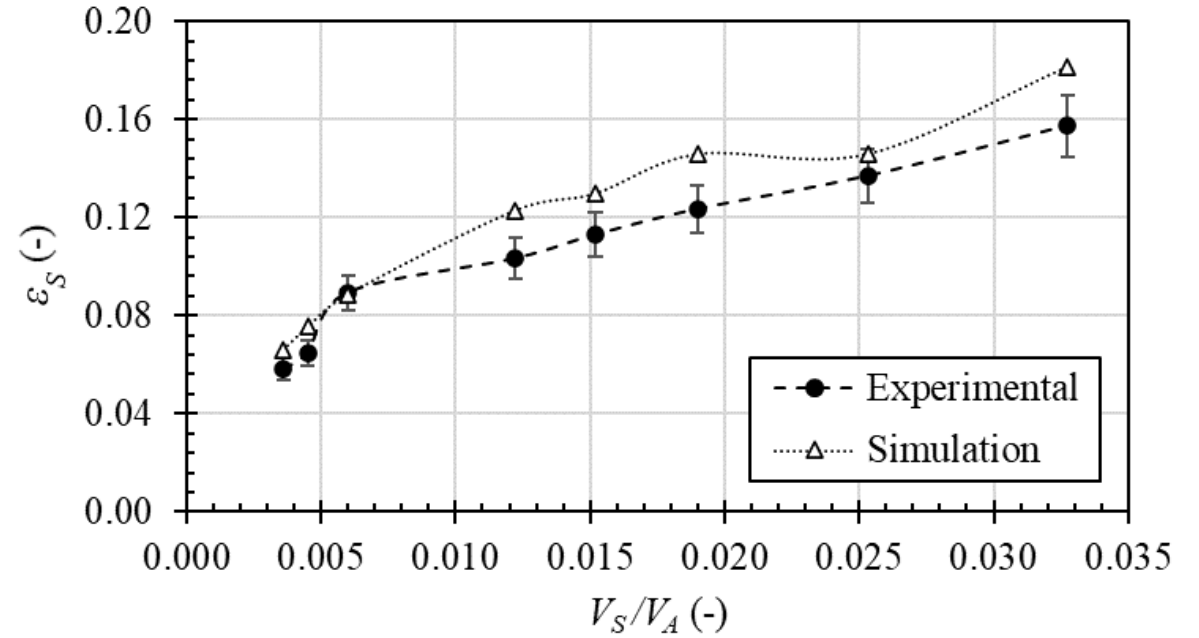
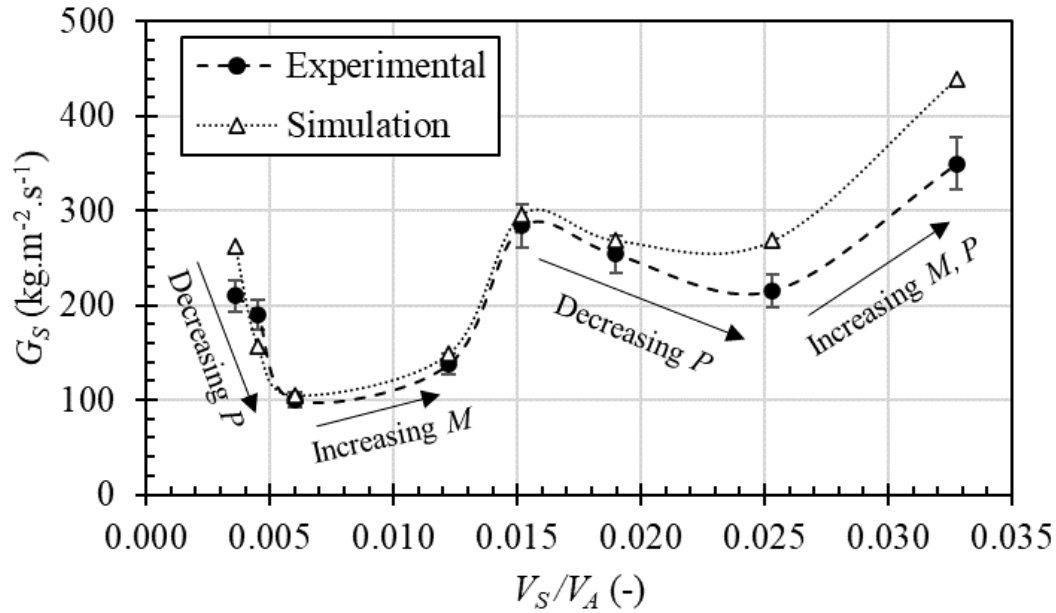

$$\frac{V_S}{V_A} = \frac{M}{\left(V - \frac{M}{\rho_p}\right) \cdot \left(\frac{T_{ref}}{T}\right) \left(\frac{P}{P_{ref}}\right) \rho_p}$$

GAS-SOLID JET PENETRATION IN FLUIDIZED BEDS⁴

● Biomass penetration in catalyst bed was measured with:

- Electrical Capacitance Volume Tomography (ECVT)
- Fluorescent particle tracking
- Pitot probes

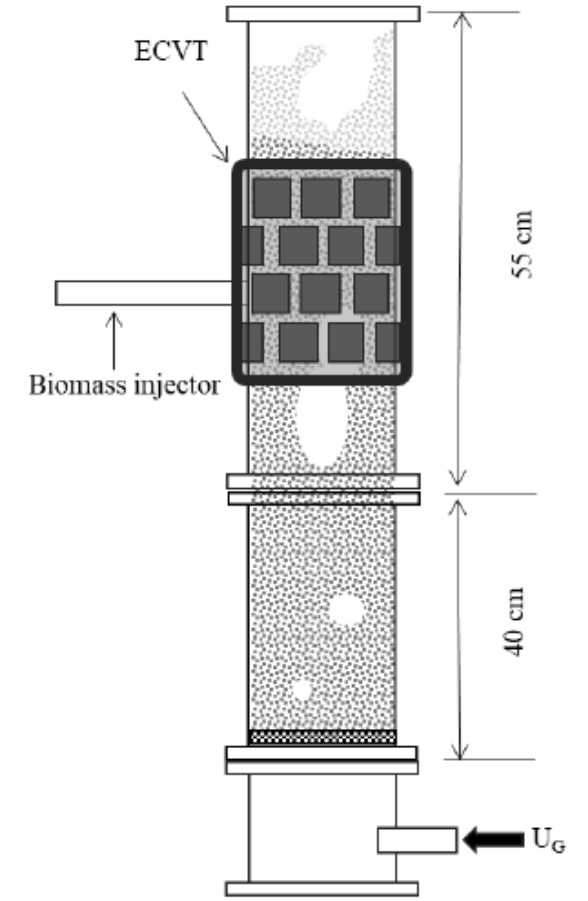
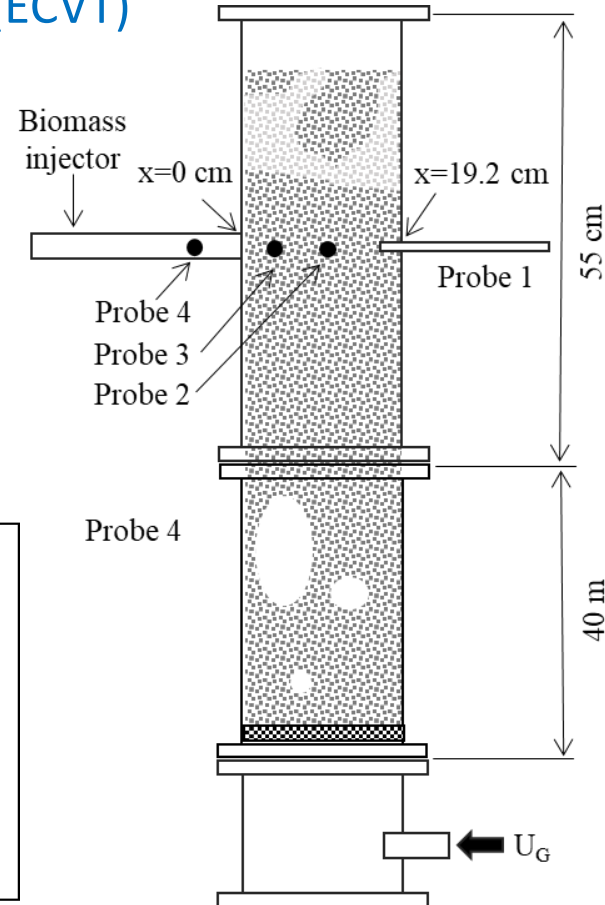
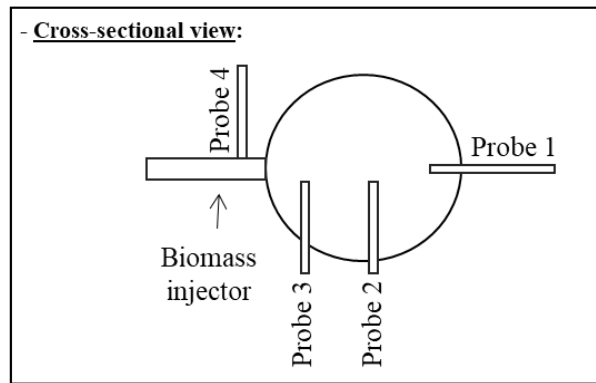

FLUORESCENT PARTICLE TRACKING⁴

- Biomass penetration directly related to the solid flux
- Effect of fluidization velocity on biomass concentration and lateral jet dispersion

$U_G=0$ m/s (fixed bed)

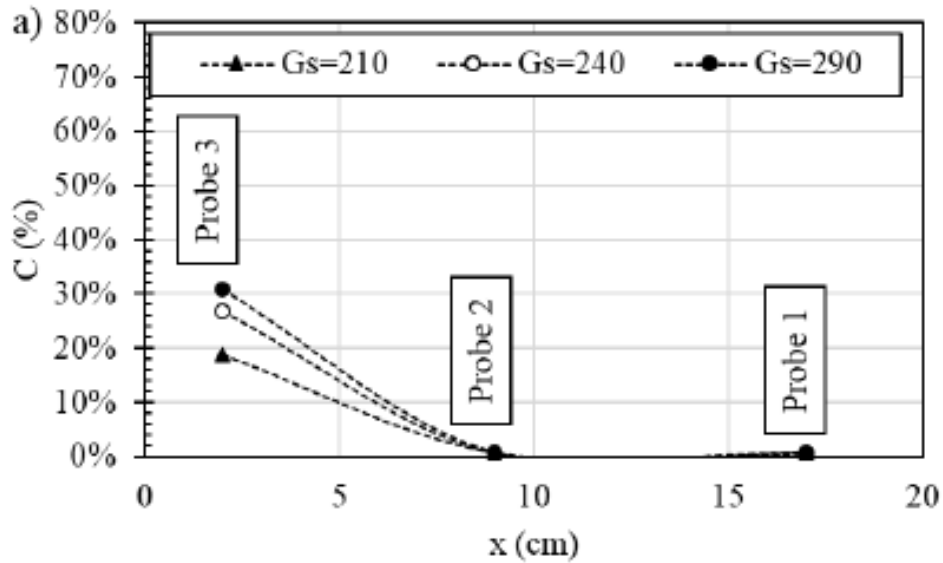

$U_G=0.5$ m/s

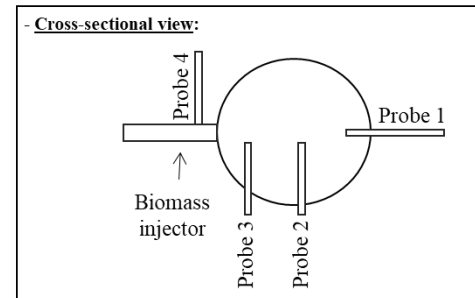
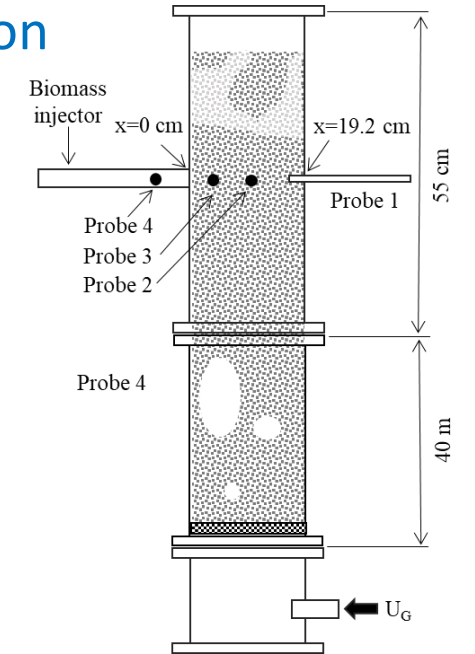
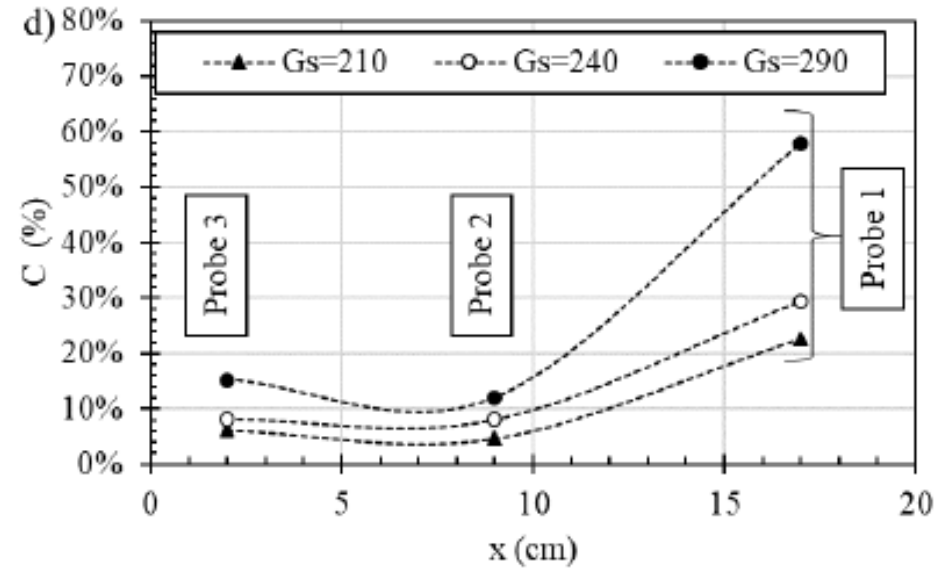

ECVT PROFILES⁴

- The technique provides voidage contours.
- Post-treatment and challenge when bubbles pass through the multiphase jet.
- The concentration of biomass along the jet is not detectable.

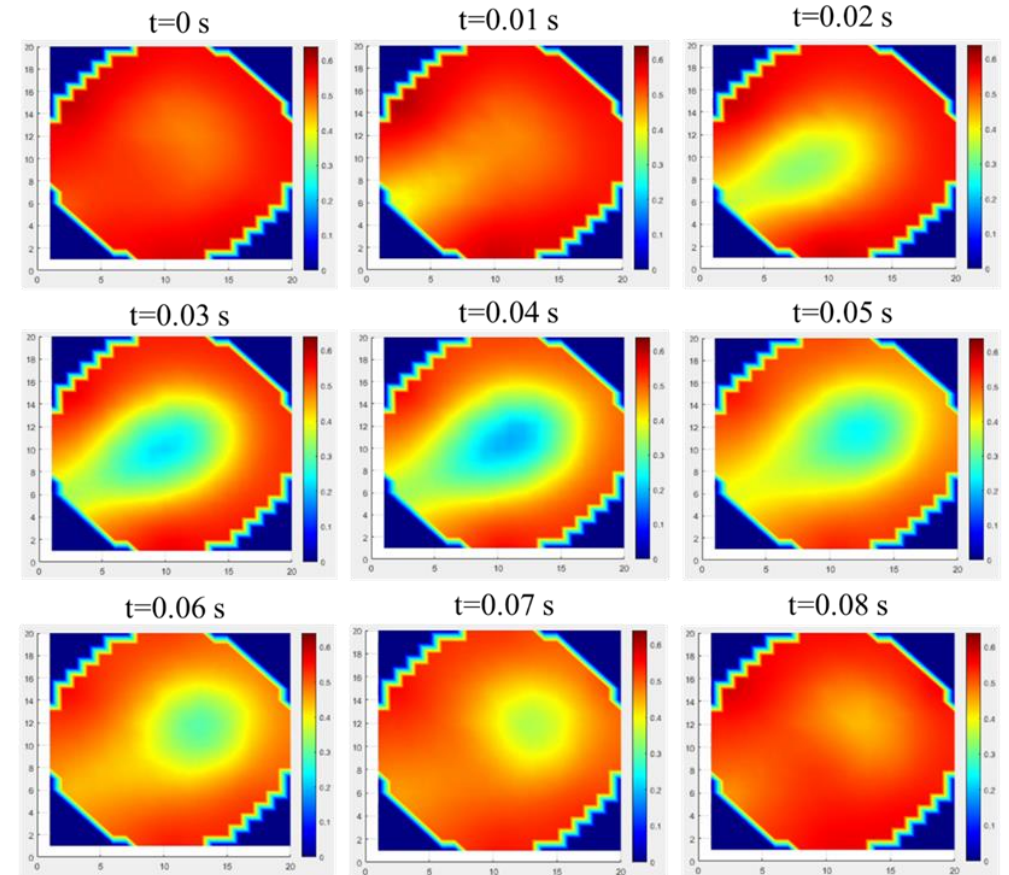
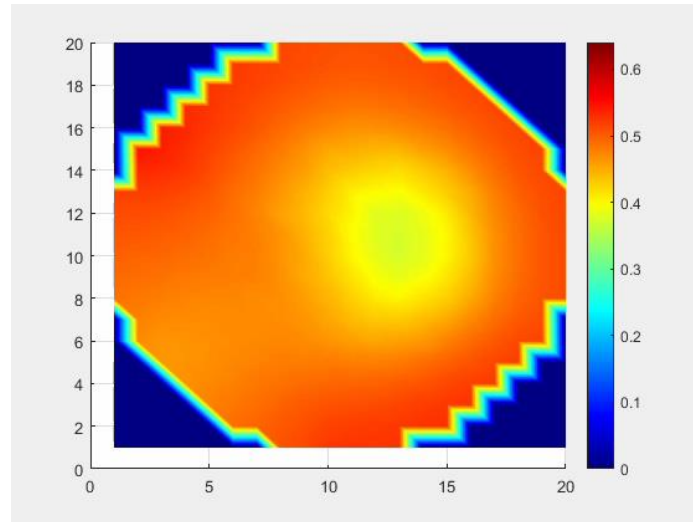

ECVT PROFILES⁴

Renewable energies

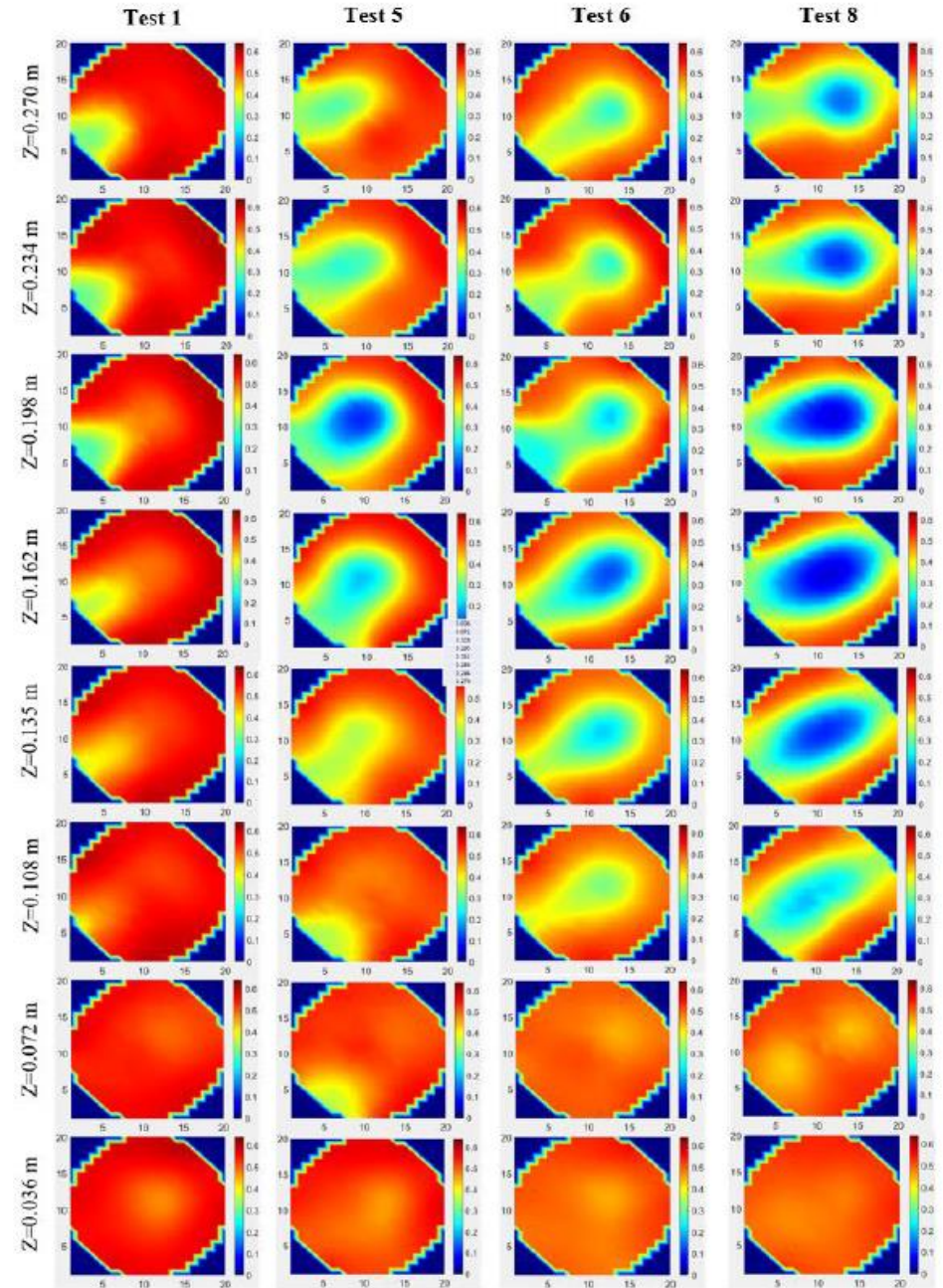
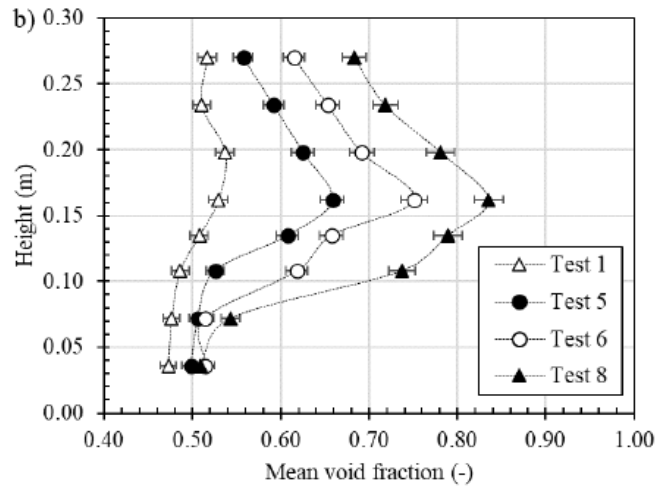
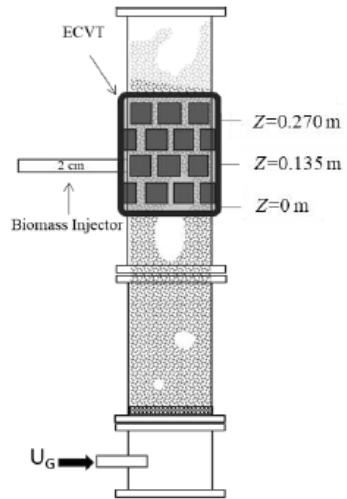
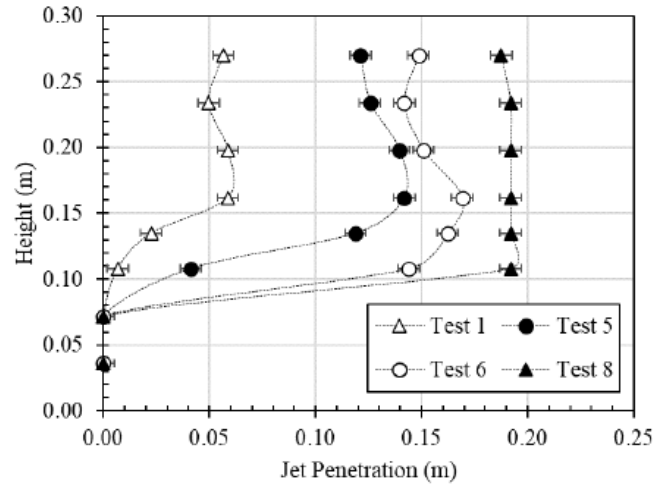
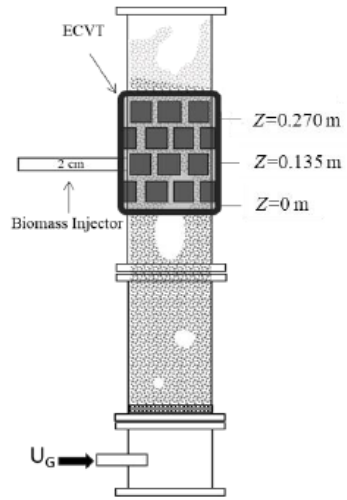

Biomass Injector Level

COMPARISON OF TECHNIQUES⁴

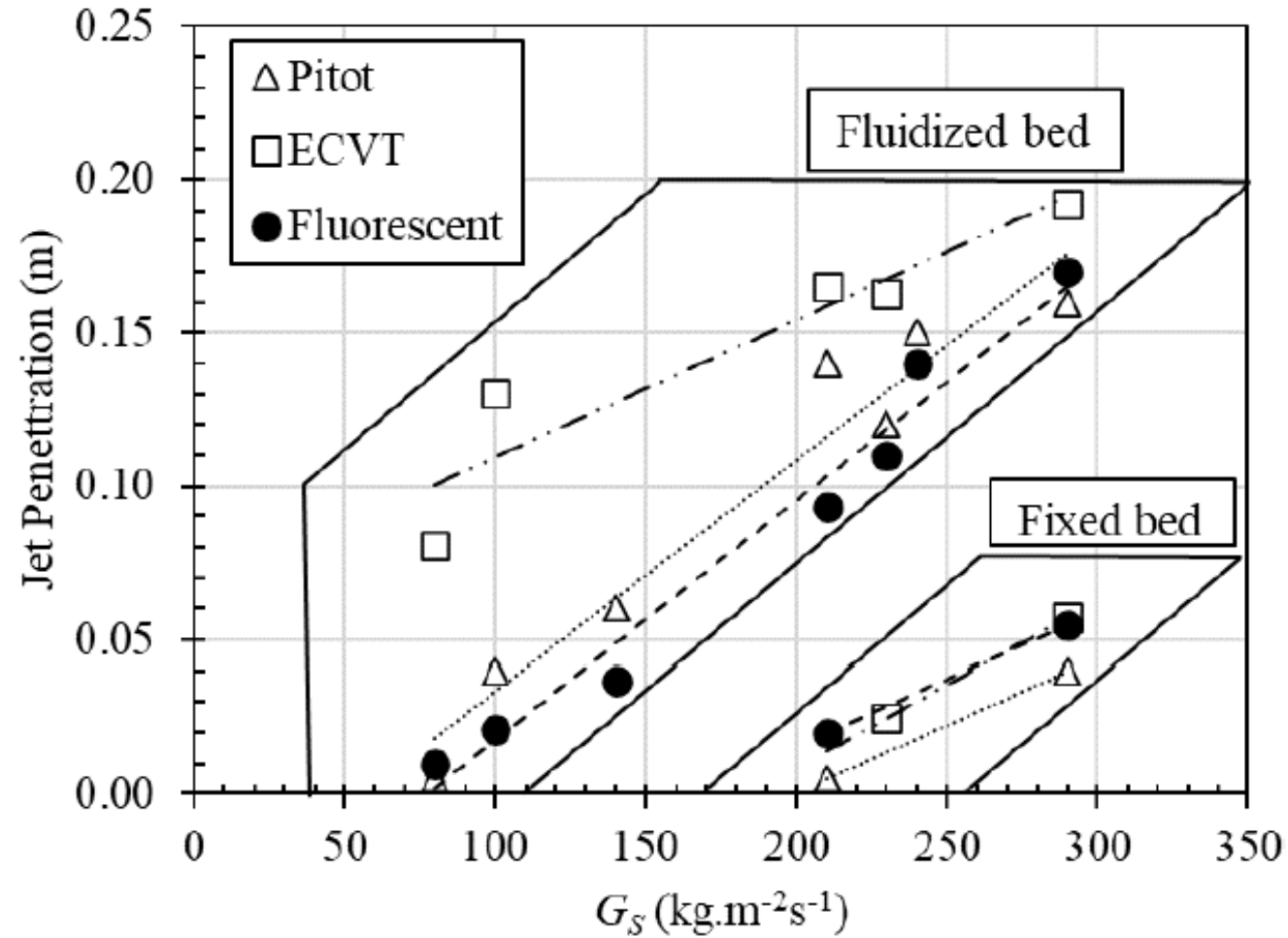

CONCLUSIONS

- **The way the experimental data is analyzed needs to be considered for modeling.**
- Hydrodynamics of a pressurized feeder for biomass injection into gas-solid units was characterized experimentally.
- MP-PIC model was tuned and compared with selected experiments to find the most adapted parameters.
- Three experimental techniques were employed to characterize the biomass penetration in the bed.
- Fluorescent particle tracking provided information on dispersion of biomass along the jet while ECVT and pitot depicted mostly the jet length.

OUTLOOK

- CFD simulation of gas-solid jet penetration
- Influence of jet penetration in fluidized bed at temperature and reaction conditions



PhD position at IFP Energies nouvelles (IFPEN)
in Chemical Engineering

**Characterization of Gas-Solid Injection into Fluidized
Bed Reactors for Biomass Residues Valorization**

PhD start: November/24

To apply: lucas.massaro-sousa@ifpen.fr

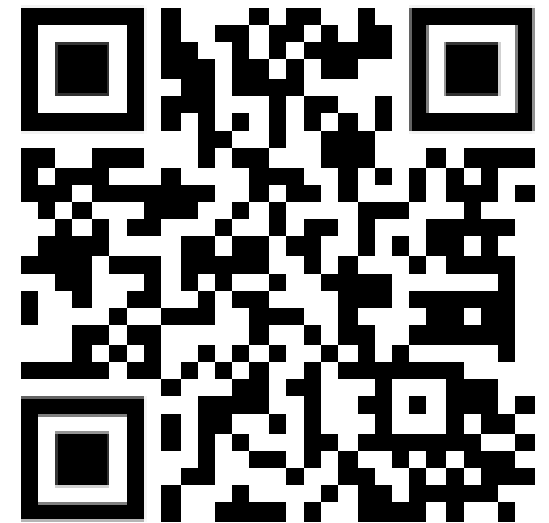

<https://euraxess.ec.europa.eu/jobs/243456>

Thank You !



Innovating for energy

Find us on:

 www.ifpenergiesnouvelles.com

 @IFPENinnovation

Dr Lucas Massaro Sousa
Chemical Engineering and Technologies Dept.
lucas.massaro-sousa@ifpen.fr